



Conducting Value

# INCCCEL

INSTRUMENTATION, CONTROL  
AND THERMOCOUPLE CABLES





CORPORATE VIDEO



ISO 9001:2015  
Certificate No. CS1-249



Assessed to ISO 9001:2015  
Cert/LPCB ref. 217



**ТехноПрогресс**

GOST ISO 9001-2011  
(ISO 9001:2008)  
certification N CдC.TII.CM.04293-14



ISO 9001:2015  
n. 9125.CAVL



ISO 14001:2015  
n. 9191.CVCL

**Our commitment to environmentally friendly products.**

CAVICEL is committed to providing our customers with environmentally friendly products in compliance with the European Union (EU) RoHS Directive (Restriction of Hazardous Substances) and REACH Regulation (Registration, Evaluation, Authorization and Restriction of Chemicals).



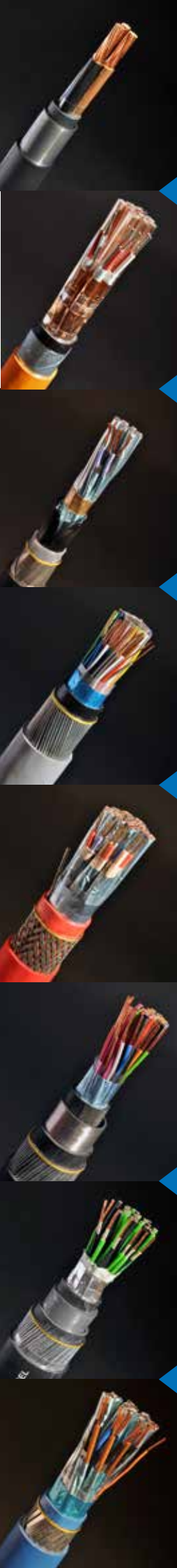

## Instrumentation, control, thermocouple and power cables.

INCOCEL Instrumentation and Control Cables are suitable for use in Heavy Industries such as Oil & Gas (Onshore and Offshore), Chemical and Petrochemical, Iron and Steel Industries.

International Standards normally prescribe materials, construction and performances required, but in many cases Instrumentation and Control Cables have to be designed and manufactured according to specific requirements.

This catalogue provides some indications on the capabilities of Caviced and its cables. Caviced has the ability to offer a wide range of cables, designed, manufactured and tested to comply with specific requirements.

With over 40 years of experience in designing and manufacturing bespoke cables for Heavy Industries Worldwide, Caviced has become a renowned partner in the industry.

***Experience is our Power.***

---

With this catalogue we try to demonstrate our experience, our way of thinking and the way we operate to create our INCOCEL cables. The cables you will see are genuine practical examples.

When it comes to your own cable we can design it together. Let us know your specific requirements and we will create your cable around them.

***Your cable, our passion.***



INSTRUMENTATION, CONTROL,  
THERMOCOUPLE AND POWER CABLES.



# CONSTRUCTION AND GENERAL INFORMATION

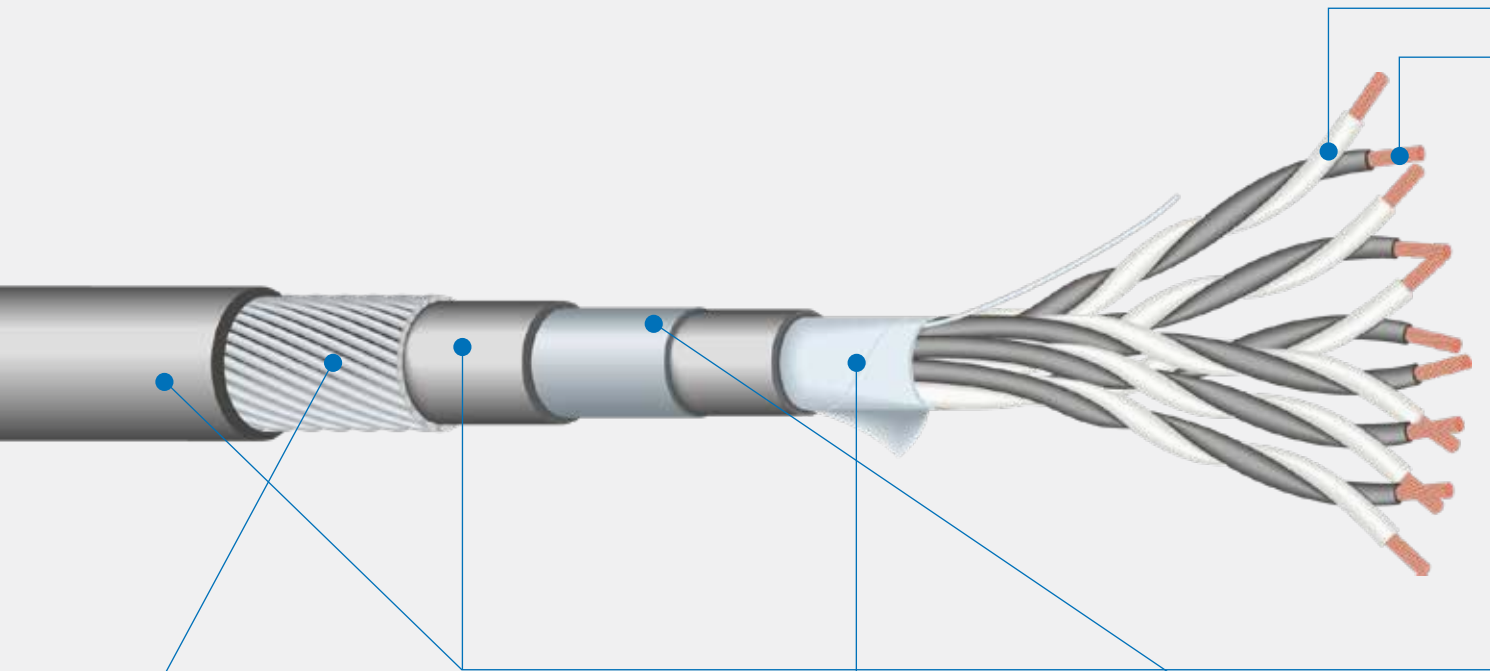

## Screening

**ALUMINIUM/POLYESTER TAPE**  
with a tinned copper drain wire, the most popular construction

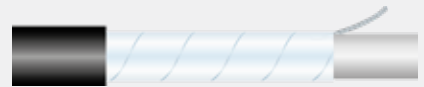

**COPPER/POLYESTER TAPE**  
with a tinned copper drain wire, for a better screen effect



**BARE COPPER BRAID**  
for electromagnetic interference or when the cable is subject to movements



**TINNED COPPER BRAID**  
for electromagnetic interference in presence of corrosive atmosphere or high temperature



## Armouring

Screens can be:

**SWA:** single layer of galvanized steel wires. This armour assures a very good mechanical protection and tensile strength.

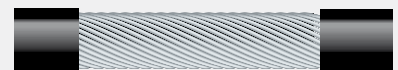

**GSWB:** galvanized steel wire braid. It assures a good mechanical resistance, allowing a lower bending radius compared to other armour. It is preferable when there is movement or vibration.



**GSTA:** galvanized steel tape armour, composed by two tapes with overlapped edge; 100%. Very good crush resistance, but fair tensile strength.



**GSFA:** galvanized steel flat armour. It is composed by flat wire, it is similar to SWA, but with higher mechanical protection.

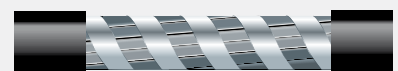

## Conductors

Are generally **bare or tinned**

For instrumentation cables conductors are generally copper for signal transmission or special alloy, for thermocouple / compensating cables.

Conductors can generally be according to EN 60288:

CLASS 1  
solid



CLASS 2  
stranded



CLASS 5  
flexible



## Insulation

The most popular materials for insulation are:

- PVC
- PE
- XLPE
- LSZH

Table "Materials" on page 16 is a general guide for the choice of insulation and jacketing materials.

## Sheath

The most popular materials for sheath are:

- PVC
- PE
- LSZH

Table "Materials" on page 16 is a general guide for the choice of insulation and jacketing materials.

## Special LSZHeat Sheath

*Cavicel has developed a high performance LSZH jacket that assures the necessary mechanical protection in hot climates like Middle East.*

*This material can assure:*

- Improved Tear Resistance at very high ambient temperature
- Improved Bending Resistance at very high ambient temperature
- No crack propagation

## Protection

### MOISTURE BARRIER

If moisture barrier is specified it shall be applied over the total cabling of elements and is possible to choose two alternatives:

Water swellable tapes



Laminated sheath, consisting of a longitudinal overlapped metallic foil, bonded to an extruded sheath.

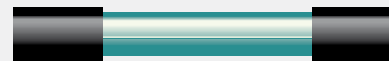

### LEAD SHEATH

It is applied between two other sheaths and is the best protection against aggressive chemicals. This is an expensive solution, increases weight and bending radius. It presents poor vibration resistance and normally an armour is required to protect it from crushing.



### HI-PACK

It is an alternative to Lead Sheath and is composed by a longitudinal overlapped aluminium copolymer coated tape bonded to HDPE jacket and additional special alloy of polyamide/ polypropylene sheath.

Excellent protection against corrosion and humidity.

Excellent impact resistance that in some cases prevents the use of the armour

This protection has a lower weight compared to lead sheath, cables have a smaller diameter, with a reduction of costs.

Hi-Pack is the right choice to protect the environment.



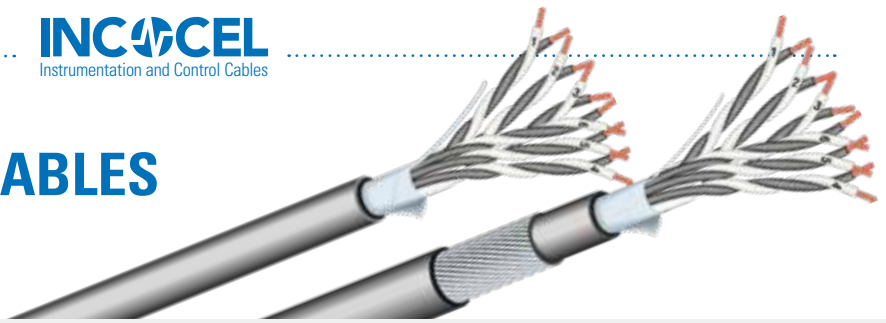

# INSTRUMENTATION CABLES

## Multipair Overall Screen

### NOT ARMoured

PE/OS/PVC  
XLPE/OS/LSZH

### ARMoured

PE/OS/PE/SWA/PVC  
XLPE/OS/LSZH/SWA/LSZH

### APPLICATIONS

Can be used in cable tray or conduit to connect electrical instrumentation and communication circuits in industrial process controls, refineries, oil and gas plants.

### OPERATING TEMPERATURE

-20 °C to +80 °C (for general use); -40 °C to +90 °C (on request).

### MINIMUM BENDING RADIUS

#### Not armoured type

12 times the outer diameter (for conductors class 1 and class 2);  
10 times the outer diameter (for conductors class 5).

#### Armoured type

15 times the outer diameter.

### CABLE CONSTRUCTION

**Conductors** Plain annealed electrolytic copper wire according to EN 60228 class 1(U) solid, class 2 (R) stranded, class 5 (F) flexible.

**Insulation** PVC, PE, XLPE or LSZH thermoplastic material.

**Twisting** The insulated cores shall be twisted in pairs for a good reduction of the electromagnetic noise.

**Cabling** The pairs/triads are cabled with suitable non hygroscopic fillers (when necessary) and wrapped with polyester tape if required.

**Overall screen** Aluminium/polyester tape, coverage >100%, aluminium in contact with tinned copper drain wire.

#### Armoured

*Inner sheath: PE, PVC or LSZH thermoplastic material.  
Armour: Single layer of galvanized steel wires (SWA).*

**Outer sheath** PVC or LSZH thermoplastic material.

### APPLICABLE STANDARDS

*Basic design* EN 50288-7 or PAS 5308

*Flame retardant* IEC 60332-1

*Fire retardant (cat. C or A according to requirements)* IEC 60332-3

*Halogen free properties (only for LSZH cables)* IEC 60754-1

*Low smoke emission (only for LSZH cables)* IEC 61034-2

### EN 50288-7 (500 V)

Cross section (mm <sup>2</sup> )	UNARMoured		ARMoured		
	Outer diameter (mm)	Weight (kg/km)	Diameter under armour (mm)	Outer diameter (mm)	Weight (kg/km)
<b>1 mm<sup>2</sup> stranded</b>	R-XLPE/OS/LSZH		R-XLPE/OS/LSZH/SWA/LSZH		
1x2x1	6,8	60	6,8	11,4	250
2x2x1	9,4	105	9,4	14,1	370
5x2x1	12,6	210	12,6	17,6	540
10x2x1	17,2	365	17,2	24,0	1080
12x2x1	18,5	425	18,5	25,3	1190
<b>1,5 mm<sup>2</sup> stranded</b>	R-XLPE/OS/LSZH		R-XLPE/OS/LSZH/SWA/LSZH		
1x2x1,5	7,4	75	7,4	12,2	280
1x3x1,5	7,8	95	7,8	12,6	310
2x2x1,5	10,2	155	10,2	15,0	420
4x2x1,5	12,7	220	12,7	17,7	550
5x2x1,5	14,1	280	14,1	19,3	660
6x2x1,5	16,4	355	16,4	21,6	780
8x2x1,5	17,3	405	17,3	24,1	1120
10x2x1,5	19,2	495	19,2	26,0	1285
12x2x1,5	20,8	580	20,8	27,8	1440
20x2x1,5	25,6	925	25,6	32,8	1980
24x2x1,5	28,7	1105	28,7	36,1	2300
<b>2,5 mm<sup>2</sup> stranded</b>	R-XLPE/OS/LSZH		R-XLPE/OS/LSZH/SWA/LSZH		
1x2x2,5	8,8	105	8,8	13,6	340
1x3x2,5	9,3	135	9,3	14,1	380
2x2x2,5	12,2	220	12,2	17,2	550
4x2x2,5	15,3	325	15,3	20,5	730
5x2x2,5	16,9	415	16,9	23,7	1120
6x2x2,5	19,7	520	19,7	26,5	1330
8x2x2,5	20,8	600	20,8	27,8	1460
10x2x2,5	23,2	745	23,2	30,1	1690
12x2x2,5	25,3	885	25,3	32,5	1930
20x2x2,5	31,1	1410	31,1	38,6	2700

approximate values

#### ELECTRICAL CHARACTERISTICS

Cross section (mm <sup>2</sup> )	1	1,5	2,5
Capacitance (pF/m)	≤150	≤150	≤150
L/R (μH/Ohm)	≤25	≤40	≤60

### PAS 5308 (300/500 V)

Cross section (mm <sup>2</sup> )	UNARMoured		ARMoured		
	Outer diameter (mm)	Weight (kg/km)	Diameter under armour (mm)	Outer diameter (mm)	Weight (kg/km)
<b>0,5 mm<sup>2</sup> solid</b>	U-PE/OS/PVC		U-PE/OS/PE/SWA/PVC		
1x2x0,5	6,3	50	6,3	10,7	200
2x2x0,5 (quad cabled)	7,1	75	7,1	11,5	260
5x2x0,5	11,6	200	11,6	16,2	460
10x2x0,5	15,0	270	15,0	20,7	790
15x2x0,5	17,1	370	17,1	22,8	1100
20x2x0,5	19,4	440	19,4	26,0	1280
30x2x0,5	23,0	630	23,0	29,8	1520
50x2x0,5	28,9	980	28,9	36,1	2100
<b>0,5 mm<sup>2</sup> flexible</b>	F-PE/OS/PVC		F-PE/OS/PE/SWA/PVC		
1x2x0,5	7,0	60	7,0	11,4	250
2x2x0,5 (quad cabled)	7,9	80	7,9	12,3	300
5x2x0,5	13,1	210	13,1	17,9	560
10x2x0,5	17,2	340	17,2	22,9	970
15x2x0,5	19,8	440	19,8	26,4	1240
20x2x0,5	22,3	570	22,3	29,1	1640
30x2x0,5	26,9	780	26,9	33,9	1770
50x2x0,5	33,9	1130	33,9	42,1	2770
<b>1 mm<sup>2</sup> solid</b>	U-PE/OS/PVC		U-PE/OS/PE/SWA/PVC		
1x2x1	7,4	85	7,4	11,8	290
2x2x1 (quad cabled)	8,4	115	8,4	13,0	345
5x2x1	14,2	290	14,2	19,7	790
10x2x1	17,4	500	17,4	24,3	1310
15x2x1	21,3	670	21,3	28,1	1740
20x2x1	24,4	950	24,4	31,2	2040
30x2x1	29,0	1030	29,0	36,2	2180
50x2x1	37,3	1750	37,3	45,7	3500
<b>1,5 mm<sup>2</sup> stranded</b>	R-PE/OS/PVC		R-PE/OS/PE/SWA/PVC		
1x2x1,5	8,3	100	8,3	12,6	320
2x2x1,5 (quad cabled)	9,7	150	9,7	14,3	420
5x2x1,5	16,4	360	16,4	22,1	940
10x2x1,5	21,6	690	21,6	28,4	1500
15x2 x1,5	25,2	880	25,2	32,2	1970
20x2x1,5	28,5	1230	28,5	36,5	2400
30x2x1,5	34,3	1560	34,3	42,5	3170
50x2x1,5	43,6	2400	43,6	53,4	5020

approximate values

#### ELECTRICAL CHARACTERISTICS

Cross section (mm <sup>2</sup> )	0,5		1		1,5	
n. of pairs	1-2	≥5	1-2	≥5	1-2	≥5
Capacitance (pF/m)	≤115	≤75	≤115	≤75	≤120	≤85
L/R (μH/Ohm)	≤25		≤25		≤40	



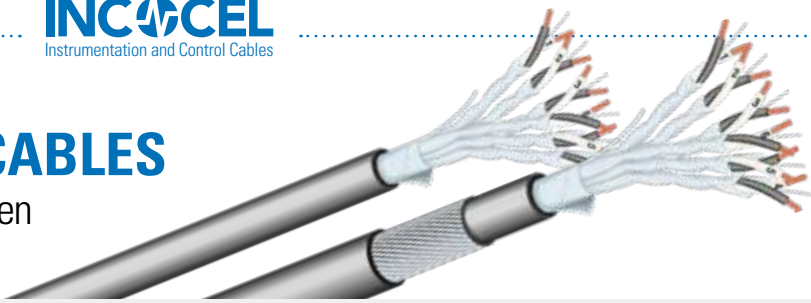

# INSTRUMENTATION CABLES

## Multipair Individual and Overall Screen

### NOT ARMoured

PE/IS/OS/PVC  
XLPE/IS/OS/LSZH

### ARMoured

PE/IS/OS/PE/SWA/PVC  
XLPE/IS/OS/LSZH/SWA/LSZH

### APPLICATIONS

Can be used in cable tray or conduit to connect electrical instrumentation and communication circuits in industrial process controls, refineries, oil and gas plants.

### OPERATING TEMPERATURE

-20 °C to +80 °C (for general use); -40 °C to +90 °C (on request).

### MINIMUM BENDING RADIUS

#### Not armoured type

12 times the outer diameter (for conductors class 1 and class 2);  
10 times the outer diameter (for conductors class 5).

#### Armoured type

15 times the outer diameter.

### CABLE CONSTRUCTION

**Conductors** Plain annealed electrolytic copper wire according to EN 60228 class 1(U) solid, class 2 (R) stranded, class 5 (F) flexible.

**Insulation** PVC, PE, XLPE or LSZH thermoplastic material.

**Twisting** The insulated cores shall be twisted in pairs for a good reduction of the electromagnetic noise.

**Individual screen** Aluminium/polyester tape, coverage >100%, aluminium in contact with tinned copper drain wire.

**Cabling** The screened pairs are cabled with suitable non hygroscopic fillers (when necessary) and wrapped with polyester tape if required.

**Overall screen** Aluminium/polyester tape, coverage >100%, aluminium in contact with tinned copper drain wire.

#### Armoured

*Inner sheath: PE, PVC or LSZH thermoplastic material.*

*Armour: Single layer of galvanized steel wires (SWA).*

**Outer sheath** PVC or LSZH thermoplastic material.

### APPLICABLE STANDARDS

*Basic design* EN 50288-7 or PAS 5308

*Flame retardant* IEC 60332-1

*Fire retardant (cat. C or A according to requirements)* IEC 60332-3

*Halogen free properties (only for LSZH cables)* IEC 60754-1

*Low smoke emission (only for LSZH cables)* IEC 61034-2

### EN 50288-7 (500 V)

Cross section (mm <sup>2</sup> )	UNARMoured		ARMoured		
	Outer diameter (mm)	Weight (kg/km)	Diameter under armour (mm)	Outer diameter (mm)	Weight (kg/km)
1 mm <sup>2</sup> stranded	R-XLPE/IS/OS/LSZH		R-XLPE/IS/OS/LSZH/SWA/LSZH		
2x2x1	11.5	150	11.5	16.5	460
5x2x1	14.9	275	14.9	20.1	675
10x2x1	20.6	480	20.6	27.6	1335
12x2x1	21.6	555	21.6	28.6	1450
1.5 mm <sup>2</sup> stranded	R-XLPE/IS/OS/LSZH		R-XLPE/IS/OS/LSZH/SWA/LSZH		
2x2x1.5	12.6	180	12.6	17.6	525
4x2x1.5	15.0	275	15.0	20.9	785
5x2x1.5	16.5	350	16.5	22.4	905
6x2x1.5	18.0	425	18.0	24.1	1020
8x2x1.5	19.3	495	19.3	25.4	1150
10x2x1.5	22.9	625	22.9	29.2	1400
12x2x1.5	24.0	720	24.0	30.3	1530
20x2x1.5	28.1	1130	28.1	35.5	2300
24x2x1.5	32.2	1365	32.2	39.8	2705
2.5 mm <sup>2</sup> stranded	R-XLPE/IS/OS/LSZH		R-XLPE/IS/OS/LSZH/SWA/LSZH		
2x2x2.5	15.0	265	15.0	20.2	665
4x2x2.5	17.9	390	17.9	23.3	870
5x2x2.5	19.6	490	19.6	26.4	1290
6x2x2.5	21.5	595	21.5	28.5	1480
8x2x2.5	23.1	710	23.1	30.1	1660
10x2x2.5	27.5	905	27.5	34.9	2045
12x2x2.5	28.9	1050	28.9	36.3	2245
20x2x2.5	33.8	1645	33.8	41.4	3045

approximate values

ELECTRICAL CHARACTERISTICS			
Cross section (mm <sup>2</sup> )	1	1.5	2.5
Capacitance (pF/m)	≤150	≤150	≤150
L/R (µH/Ohm)	≤25	≤40	≤60

### PAS 5308 (300/500 V)

Cross section (mm <sup>2</sup> )	UNARMoured		ARMoured		
	Outer diameter (mm)	Weight (kg/km)	Diameter under armour (mm)	Outer diameter (mm)	Weight (kg/km)
0.5 mm <sup>2</sup> solid	U-PE/IS/OS/PVC		U-PE/IS/OS/PE/SWA/PVC		
2x2x0.5	10.3	150	10.3	14.9	380
5x2x0.5	13.5	250	13.5	19.0	640
10x2x0.5	18.3	380	18.3	24.2	890
15x2x0.5	21.1	490	21.1	27.7	1350
20x2x0.5	23.5	640	23.5	30.3	1470
30x2x0.5	27.9	970	27.9	34.9	1870
50x2x0.5	36.1	1470	36.1	44.5	3000
0.5 mm <sup>2</sup> flexible	F-PE/IS/OS/PVC		F-PE/IS/OS/PE/SWA/PVC		
2x2x0.5	12.0	100	12.0	16.8	460
5x2x0.5	15.2	250	15.2	20.9	760
10x2x0.5	21.1	480	21.1	27.9	1300
15x2x0.5	24.5	570	24.5	31.3	1440
20x2x0.5	27.3	780	27.3	31.3	1870
30x2x0.5	32.3	1020	32.3	34.3	2400
50x2x0.5	41.7	1680	41.7	51.5	3930
1 mm <sup>2</sup> solid	U-PE/IS/OS/PVC		U-PE/IS/OS/PE/SWA/PVC		
2x2x1	12.8	200	12.8	17.6	515
5x2x1	16.2	290	16.2	21.9	950
10x2x1	22.6	580	22.6	29.4	1330
15x2x1	26.2	780	26.2	33.2	1680
20x2x1	29.8	1010	29.8	37.8	2540
30x2x1	35.4	1430	35.4	43.8	2900
50x2x1	44.9	2360	44.9	54.9	4800
1.5 mm <sup>2</sup> stranded	R-PE/IS/OS/PVC		R-PE/IS/OS/PE/SWA/PVC		
2x2x1.5	14.7	250	14.7	20.4	730
5x2x1.5	18.8	460	18.8	25.4	1180
10x2x1.5	26.5	760	26.5	33.5	1820
15x2x1.5	30.8	1020	30.8	38.8	2350
20x2x1.5	34.4	1350	34.4	42.6	3030
30x2x1.5	41.0	1900	41.0	50.8	4050
50x2x1.5	52.2	3060	52.2	62.6	5960

approximate values

ELECTRICAL CHARACTERISTICS			
Cross section (mm <sup>2</sup> )	0.5	1	1.5
Capacitance (pF/m)	≤115	≤115	≤120
L/R (µH/Ohm)	≤25	≤25	≤40

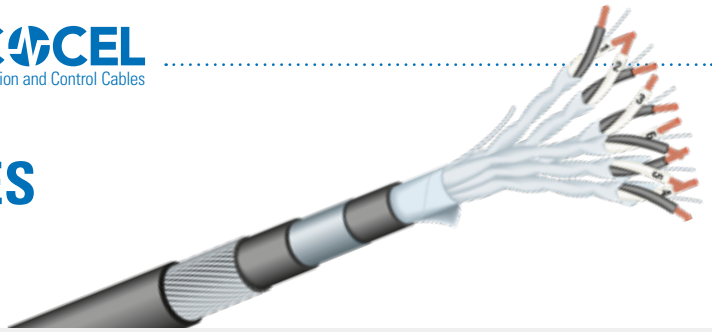

# INSTRUMENTATION CABLES

Multipair Individual and Overall Screen,  
Armoured and Lead Sheathed

PE/IS/OS/PVC/LC/PVC/SWA/PVC  
XLPE/IS/OS/LSZH/LC/LSZH/SWA/LSZH

## APPLICATIONS

Can be used in cable tray or conduit to connect electrical instrumentation and communication circuits in industrial process controls, refineries, oil and gas plant.  
Excellent protection against corrosion, humidity and poor vibration resistance.

## OPERATING TEMPERATURE

-20 °C to +80 °C (for general use); -40 °C to +90 °C (on request).

## MINIMUM BENDING RADIUS

20 times the outer diameter.

## CABLE CONSTRUCTION

**Conductors** Plain annealed electrolytic copper wire according to EN 60228 class 1(U) solid, class 2 (R) stranded, class 5 (F) flexible.

**Insulation** PVC, PE, XLPE or LSZH thermoplastic material.

**Twisting** The insulated cores shall be twisted in pairs for a good reduction of the electromagnetic noise.

**Individual screen** Aluminium/polyester tape, coverage >100%, aluminium in contact with tinned copper drain wire.

**Cabling** The screened pairs are cabled with suitable non hygroscopic fillers (when necessary) and wrapped with polyester tape if required.

**Overall screen** Aluminium/polyester tape, coverage >100%, aluminium in contact with tinned copper drain wire.

**Bedding** PVC or LSZH thermoplastic material.

**Lead Sheath** Lead alloy.

**Inner sheath** PE, PVC or LSZH thermoplastic material.

**Armour** Single layer of galvanized steel wires (SWA).

**Outer sheath** PVC or LSZH thermoplastic material.

## APPLICABLE STANDARDS

*Basic design* EN 50288-7 or PAS 5308

*Flame retardant* IEC 60332-1

*Fire retardant (cat. C or A according to requirements)* IEC 60332-3

*Halogen free properties (only for LSZH cables)* IEC 60754-1

*Low smoke emission (only for LSZH cables)* IEC 61034-2

## EN 50288-7 (300 V)

Cross section (mm <sup>2</sup> )	Diameter under armour (mm)	Outer diameter (mm)	Weight (kg/km)
0,5 mm <sup>2</sup> stranded	R-XLPE/IS/OS/LSZH/LC/LSZH/SWA/LSZH		
1x2x0,5	9,9	14,6	566
4x2x0,5	16,4	21,3	1462
6x2x0,5	19,1	24,0	1848
12x2x0,5	23,0	28,7	2467
15x2x0,5	25,3	31,0	2894
24x2x0,5	30,3	36,2	3724
0,75 mm <sup>2</sup> stranded	R-XLPE/IS/OS/LSZH/LC/LSZH/SWA/LSZH		
1x2x0,75	10,1	14,8	585
4x2x0,75	16,9	21,9	1498
6x2x0,75	19,7	24,7	1901
12x2x0,75	24,0	29,7	2753
15x2x0,75	26,4	32,3	3103
24x2x0,75	31,7	37,8	4623
1 mm <sup>2</sup> stranded	R-XLPE/IS/OS/LSZH/LC/LSZH/SWA/LSZH		
1x2x1	10,8	15,4	659
4x2x1	18,3	23,2	1775
6x2x1	20,9	26,0	2286
12x2x1	25,6	31,6	3158
15x2x1	28,2	34,2	3682
24x2x1	33,9	40,1	4711
1,5 mm <sup>2</sup> stranded	R-XLPE/IS/OS/LSZH/LC/LSZH/SWA/LSZH		
1x2x1,5	11,5	16,2	722
4x2x1,5	19,8	24,9	2106
6x2x1,5	22,9	28,8	2470
12x2x1,5	28,1	34,3	3695
15x2x1,5	31,2	37,3	4573
24x2x1,5	37,9	45,1	5553

approximate values

ELECTRICAL CHARACTERISTICS				
Cross section (mm <sup>2</sup> )	0,5	0,75	1	1,5
Capacitance (pF/m)	≤150	≤150	≤150	≤150
L/R (μH/Ohm)	≤25	≤25	≤25	≤40

## PAS 5308 (300/500 V)

Cross section (mm <sup>2</sup> )	Diameter under armour (mm)	Outer diameter (mm)	Weight (kg/km)
0,5 mm <sup>2</sup> solid	U-PE/IS/OS/PVC/LC/PVC/SWA/PVC		
2x2x0,5	14,1	19,6	1267
5x2x0,5	17,3	23,0	1775
2x2x0,5	22,7	29,3	2695
15x2x0,5	25,7	32,7	3172
20x2x0,5	28,7	36,5	4374
0,5 mm <sup>2</sup> flexible	F-PE/IS/OS/PVC/LC/PVC/SWA/PVC		
2x2x0,5	15,8	21,5	1562
5x2x0,5	19,4	26,0	2280
10x2x0,5	25,7	32,7	3172
15x2x0,5	29,7	37,7	4650
20x2x0,5	32,7	40,9	4817
1 mm <sup>2</sup> solid	U-PE/IS/OS/PVC/LC/PVC/SWA/PVC		
2x2x1	16,6	22,3	1600
5x2x1	20,6	27,2	2240
10x2x1	27,2	34,2	3681
15x2x1	31,6	39,8	4658
20x2x1	35,4	43,8	5647
1,5 mm <sup>2</sup> stranded	R-PE/IS/OS/PVC/LC/PVC/SWA/PVC		
2x2x1,5	18,9	25,5	2154
5x2x1,5	23,2	30,0	2753
10x2x1,5	31,9	40,1	4711
15x2x1,5	36,4	44,8	5553
20x2x1,5	40,6	50,2	7350

approximate values

Electrical Characteristics			
Cross section (mm <sup>2</sup> )	0,5	1	1,5
Capacitance (pF/m)	≤115	≤115	≤120
L/R (μH/Ohm)	≤25	≤25	≤40

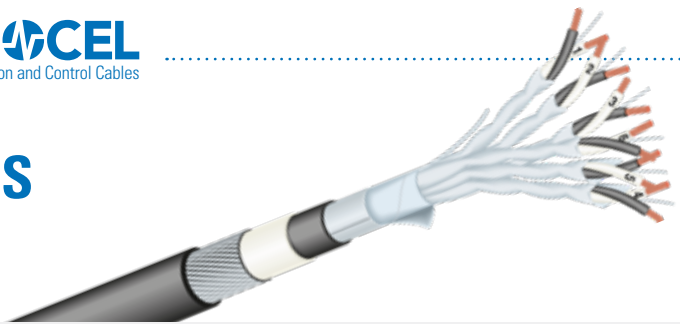

# INSTRUMENTATION CABLES

Multipair Individual and Overall Screen,  
Armoured and with Hi-Pack protection

PE/IS/OS/HIPK/SWA/PVC  
XLPE/IS/OS/HIPK/SWA/LSZH

## APPLICATIONS

This is an alternative to lead sheath and can be used in cable tray, conduit or direct burial to connect electrical instrumentation and communication circuits in industrial process controls.

This protection has lower weight and smaller diameter compared to lead sheath.

Excellent protection against corrosion, humidity, in petrochemical plants.

## OPERATING TEMPERATURE

-20 °C to +80 °C (for general use); -40 °C to +90 °C (on request).

## MINIMUM BENDING RADIUS

20 times the outer diameter.

## CABLE CONSTRUCTION

**Conductors** Plain annealed electrolytic copper wire according to EN 60228 class 1(U) solid, class 2 (R) stranded, class 5 (F) flexible.

**Insulation** PVC, PE, XLPE or LSZH thermoplastic material.

**Twisting** The insulated cores shall be twisted in pairs for a good reduction of the electromagnetic noise.

**Individual screen** Aluminium/polyester tape, coverage >100%, aluminium in contact with tinned copper drain wire.

**Cabling** The screened pairs are cabled with suitable non hygroscopic fillers (when necessary) and wrapped with polyester tape if required.

**Overall screen** Aluminium/polyester tape, coverage >100%, aluminium in contact with tinned copper drain wire.

**Hi-Pack protection** Aluminium tape coated with a protective plastic coating, longitudinally applied, bonded to black extruded bedding of High Density Polyethylene compound plus an additional Polyamide-Polypropylene special thermoplastic alloy.

**Armour** Single layer of galvanized steel wires (SWA).

**Outer sheath** PVC or LSZH thermoplastic material.

## APPLICABLE STANDARDS

*Basic design* EN 50288-7 or PAS 5308

*Flame retardant* IEC 60332-1

*Halogen free properties (only for LSZH cables)* IEC 60754-1

*Low smoke emission (only for LSZH cables)* IEC 61034-2

## EN 50288-7 (300 V)

Cross section (mm <sup>2</sup> )	Diameter under armour (mm)	Outer diameter (mm)	Weight (kg/km)	
0,5 mm <sup>2</sup> stranded	R-XLPE/IS/OS/HIPK/SWA/LSZH			
1x2x0,5	7,9	11,7	283	
4x2x0,5	13,1	17,0	731	
6x2x0,5	15,3	19,2	924	
12x2x0,5	18,4	23,0	1234	
15x2x0,5	20,2	24,8	1447	
24x2x0,5	24,2	29,0	1862	
0,75 mm <sup>2</sup> stranded	R-XLPE/IS/OS/HIPK/SWA/LSZH			
1x2x0,75	8,1	11,8	293	
4x2x0,75	13,5	17,5	749	
6x2x0,75	15,8	19,8	951	
12x2x0,75	19,2	23,8	1377	
15x2x0,75	21,1	25,8	1552	
24x2x0,75	25,4	30,2	2312	
1 mm <sup>2</sup> stranded	R-XLPE/IS/OS/HIPK/SWA/LSZH			
1x2x1	8,6	12,3	330	
4x2x1	14,6	18,6	888	
6x2x1	16,7	20,8	1143	
12x2x1	20,5	25,3	1579	
15x2x1	22,6	27,4	1841	
24x2x1	27,1	32,1	2356	
1,5 mm <sup>2</sup> stranded	R-XLPE/IS/OS/HIPK/SWA/LSZH			
1x2x1,5	9,2	13,0	361	
4x2x1,5	15,8	19,9	1053	
6x2x1,5	18,3	23,0	1235	
12x2x1,5	22,5	27,4	1848	
15x2x1,5	25,0	29,8	2287	
24x2x1,5	30,3	36,1	2777	
approximate values				
<b>Electrical Characteristics</b>				
Cross section (mm <sup>2</sup> )	0,5	0,75	1	1,5
Capacitance (pF/m)	≤150	≤150	≤150	≤150
L/R (μH/Ohm)	≤25	≤25	≤25	≤40

## PAS 5308 (300/500 V)

Cross section (mm <sup>2</sup> )	Diameter under armour (mm)	Outer diameter (mm)	Weight (kg/km)
0,5 mm <sup>2</sup> solid	U-PE/IS/OS/HIPK/SWA/PVC		
2x2x0,5	11,3	15,7	634
5x2x0,5	13,8	18,4	888
10x2x0,5	18,2	23,4	1348
15x2x0,5	20,6	26,2	1586
20x2x0,5	23,0	29,2	2187
0,5 mm <sup>2</sup> flexible	F-PE/IS/OS/HIPK/SWA/PVC		
2x2x0,5	12,6	17,2	781
5x2x0,5	15,5	20,8	1140
10x2x0,5	20,6	26,2	1586
15x2x0,5	23,8	30,2	2325
20x2x0,5	26,2	32,7	2409
1 mm <sup>2</sup> solid	U-PE/IS/OS/HIPK/SWA/PVC		
2x2x1	13,3	17,8	800
5x2x1	16,5	21,8	1120
10x2x1	21,8	27,4	1841
15x2x1	25,3	31,8	2329
20x2x1	28,3	35,0	2824
1,5 mm <sup>2</sup> stranded	R-PE/IS/OS/HIPK/SWA/PVC		
2x2x1,5	15,1	20,4	1077
5x2x1,5	18,6	24,0	1377
10x2x1,5	25,5	32,1	2356
15x2x1,5	29,1	35,8	2777
20x2x1,5	32,5	40,2	3675
approximate values			
<b>Electrical Characteristics</b>			
Cross section (mm <sup>2</sup> )	0,5	1	1,5
Capacitance (pF/m)	≤115	≤115	≤120
L/R (μH/Ohm)	≤25	≤25	≤40

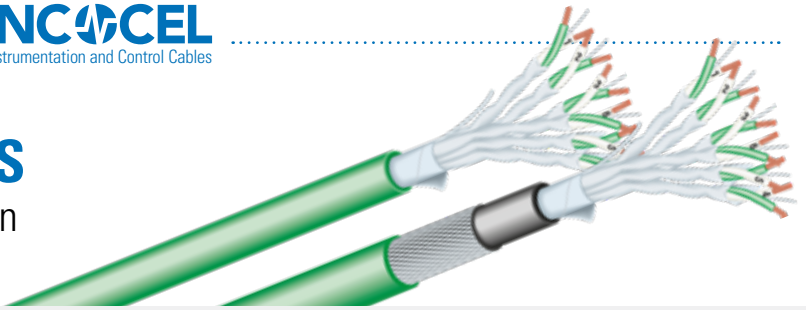

# THERMOCOUPLE CABLES

## Multipair Individual and Overall Screen

**NOT ARMoured**  
XLPE/IS/OS/LSZH

**ARMoured**  
XLPE/IS/OS/LSZH/SWA/LSZH

### APPLICATIONS

Can be used in cable tray or conduit to connect different types of thermocouple in industrial process controls, refineries, oil and gas plants.

### OPERATING TEMPERATURE

-20 °C to +80 °C (for general use); -40 °C to +90 °C (on request).

### MINIMUM BENDING RADIUS

#### Not armoured type

12 times the outer diameter (for conductors class 1 and class 2);  
10 times the outer diameter (for conductors class 5).

#### Armoured type

15 times the outer diameter.

### CABLE CONSTRUCTION

**Conductors** Solid alloy.

**Calibration** ANSI MC 96.1 or IEC 60584-3.

**Insulation** PVC, PE, XLPE or LSZH thermoplastic material.

**Twisting** The insulated cores shall be twisted in pairs for a good reduction of the electromagnetic noise.

**Individual screen** Aluminium/polyester tape, coverage >100%, aluminium in contact with tinned copper drain wire.

**Cabling** The screened pairs are cabled with suitable non hygroscopic fillers (when necessary) and wrapped with polyester tape if required.

**Overall screen** Aluminium/polyester tape, coverage >100%, aluminium in contact with tinned copper drain wire.

#### Armoured

*Inner sheath: PE, PVC or LSZH thermoplastic material.*

*Armour: Single layer of galvanized steel wires (SWA).*

**Outer sheath** PVC or LSZH thermoplastic material.

### APPLICABLE STANDARDS

*Basic design* EN 50288-7

*Flame retardant* IEC 60332-1

*Fire retardant (cat. C or A according to requirements)* IEC 60332-3

*Halogen free properties (only for LSZH cables)* IEC 60754-1

*Low smoke emission (only for LSZH cables)* IEC 61034-2

## EN 50288-7 (300 V)

Cross section (AWG)	UNARMoured		ARMoured		
	Outer diameter (mm)	Weight (kg/km)	Diameter under armour (mm)	Outer diameter (mm)	Weight (kg/km)
<b>20 AWG solid</b>	U-XLPE/IS/OS/LSZH		U-XLPE/IS/OS/LSZH/SWA/LSZH		
1x2x20	5,1	51	5,1	9,5	217
2x2x20	7,7	100	7,7	12,3	369
4x2x20	8,9	150	8,9	13,5	451
6x2x20	10,6	220	10,6	15,3	666
12x2x20	14,0	360	14,0	18,9	901
16x2x20	15,6	480	15,6	21,3	1302
24x2x20	19,4	690	19,4	25,3	1647
<b>18 AWG solid</b>	U-XLPE/IS/OS/LSZH		U-XLPE/IS/OS/LSZH/SWA/LSZH		
1x2x18	5,8	60	5,8	10,9	252
2x2x18	8,9	140	8,9	14,2	423
4x2x18	10,3	200	10,3	15,8	652
6x2x18	12,4	280	12,4	17,9	787
12x2x18	16,4	490	16,4	22,2	1327
16x2x18	18,3	630	18,3	24,2	1572
24x2x18	22,8	930	22,8	29,0	2074
<b>16 AWG solid</b>	U-XLPE/IS/OS/LSZH		U-XLPE/IS/OS/LSZH/SWA/LSZH		
1x2x16	6,8	63	6,8	12,0	283
2x2x16	10,7	180	10,7	16,2	473
4x2x16	12,6	270	12,6	18,1	742
6x2x16	15,1	360	15,1	20,8	911
12x2x16	20,3	640	20,3	26,2	1496
16x2x16	22,6	860	22,6	28,7	1915
24x2x16	28,4	1250	28,4	35,5	2663

approximate values

Electrical Characteristics			
Cross section (AWG)	20	18	16
Capacitance (pF/m)	≤150	≤150	≤150
L/R (μH/Ohm)	≤25	≤25	≤25

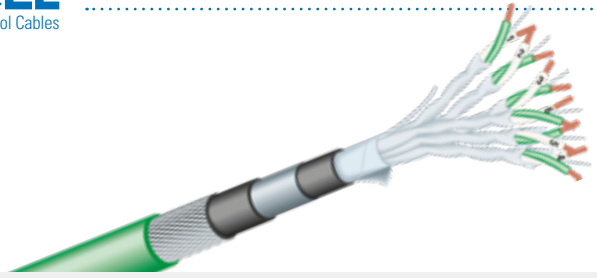

# THERMOCOUPLE CABLES

Multipair Individual and Overall Screen,  
Armoured and Lead Sheathed

XLPE/IS/OS/LSZH/LC/LSZH/SWA/LSZH

## APPLICATIONS

Can be used in cable tray or conduit to connect different types of thermocouple in industrial process controls, refineries, oil and gas plant.

Excellent protection against corrosion, humidity and poor vibration resistance.

## OPERATING TEMPERATURE

-20 °C to +80 °C (for general use); -40 °C to +90 °C (on request).

## MINIMUM BENDING RADIUS

20 times the outer diameter.

## CABLE CONSTRUCTION

**Conductors** Solid alloy.

**Calibration** ANSI MC 96.1 or IEC 60584-3.

**Insulation** PVC, PE, XLPE or LSZH thermoplastic material.

**Twisting** The insulated cores shall be twisted in pairs for a good reduction of the electromagnetic noise.

**Individual screen** Aluminium/polyester tape, coverage >100%, aluminium in contact with tinned copper drain wire.

**Cabling** The screened pairs are cabled with suitable non hygroscopic fillers (when necessary) and wrapped with polyester tape if required.

**Overall screen** Aluminium/polyester tape, coverage >100%, aluminium in contact with tinned copper drain wire.

**Bedding** PVC or LSZH thermoplastic material.

**Lead Sheath** Lead alloy.

**Inner sheath** PVC or LSZH thermoplastic material.

**Armour** Single layer of galvanized steel wires (SWA).

**Outer sheath** PVC or LSZH thermoplastic material.

## APPLICABLE STANDARDS

*Basic design* EN 50288-7

*Flame retardant* IEC 60332-1

*Fire retardant (cat. C or A according to requirements)* IEC 60332-3

*Halogen free properties (only for LSZH cables)* IEC 60754-1

*Low smoke emission (only for LSZH cables)* IEC 61034-2

## EN 50288-7 (300 V)

Cross section (AWG)	Diameter under armour (mm)	Outer diameter (mm)	Weight (kg/km)
20 AWG solid	U-XLPE/IS/OS/LSZH/LC/LSZH/SWA/LSZH		
1x2x20	7,1	13,3	716
2x2x20	10,8	17,2	1218
4x2x20	12,5	18,9	1488
6x2x20	14,8	21,4	2198
12x2x20	19,6	26,5	2973
16x2x20	21,8	29,8	4297
24x2x20	27,2	35,4	5435
18 AWG solid	U-XLPE/IS/OS/LSZH/LC/LSZH/SWA/LSZH		
1x2x18	8,1	15,3	832
2x2x18	12,5	19,9	1396
4x2x18	14,4	22,1	2152
6x2x18	17,4	25,1	2597
12x2x18	23,0	31,1	4379
16x2x18	25,6	33,9	5188
24x2x18	31,9	40,6	6844
16 AWG solid	U-XLPE/IS/OS/LSZH/LC/LSZH/SWA/LSZH		
1x2x16	9,5	16,8	934
2x2x16	15,0	22,7	1561
4x2x16	17,6	25,3	2449
6x2x16	21,1	29,1	3006
12x2x16	28,4	36,7	4937
16x2x16	31,6	40,2	6320
24x2x16	39,8	49,7	8788

approximate values

Electrical Characteristics			
Cross section (AWG)	20	18	16
Capacitance (pF/m)	≤150	≤150	≤150
L/R (μH/Ohm)	≤25	≤25	≤25

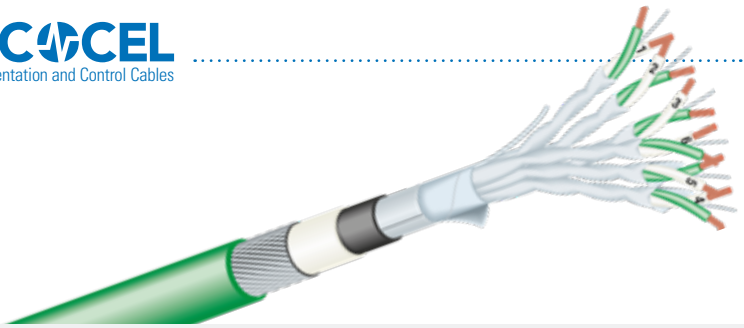

# THERMOCOUPLE CABLES

Multipair Individual and Overall Screen, Armoured and with Hi-Pack protection

XLPE/IS/OS/HIPK/SWA/LSZH

## APPLICATIONS

This is an alternative to lead sheathed cables and can be used in cable tray, conduit or direct burial to connect different types of thermocouple in industrial process controls. This protection has lower weight and smaller diameter compared to lead sheath. Excellent protection against corrosion, humidity, in petrochemical plants.

## OPERATING TEMPERATURE

-20 °C to +80 °C (for general use); -40 °C to +90 °C (on request).

## MINIMUM BENDING RADIUS

20 times the outer diameter.

## CABLE CONSTRUCTION

**Conductors** Solid alloy.

**Calibration** ANSI MC 96.1 or IEC 60584-3.

**Insulation** PVC, PE, XLPE or LSZH thermoplastic material.

**Twisting** The insulated cores shall be twisted in pairs for a good reduction of the electromagnetic noise.

**Individual screen** Aluminium/polyester tape, coverage >100%, aluminium in contact with tinned copper drain wire.

**Cabling** The screened pairs are cabled with suitable non hygroscopic fillers (when necessary) and wrapped with polyester tape if required.

**Overall screen** Aluminium/polyester tape, coverage >100%, aluminium in contact with tinned copper drain wire.

**Hi-Pack protection** Aluminium tape coated with a protective plastic coating, longitudinally applied, bonded to black extruded bedding of High Density Polyethylene compound plus an additional Polyamide-Polypropylene special thermoplastic alloy.

**Armour** Single layer of galvanized steel wires (SWA).

**Outer sheath** PVC or LSZH thermoplastic material.

## APPLICABLE STANDARDS

*Basic design* EN 50288-7

*Flame retardant* IEC 60332-1

*Halogen free properties (only for LSZH cables)* IEC 60754-1

*Low smoke emission (only for LSZH cables)* IEC 61034-2

## EN 50288-7 (300 V)

Cross section (AWG)	Diameter under armour (mm)	Outer diameter (mm)	Weight (kg/km)
<b>20 AWG solid</b>			
U-XLPE/IS/OS/HIPK/SWA/LSZH			
1x2x20	5,7	10,6	358
2x2x20	8,6	13,8	609
4x2x20	10,0	15,1	744
6x2x20	11,8	17,1	1099
12x2x20	15,7	21,2	1487
16x2x20	17,4	23,8	2149
24x2x20	21,8	28,3	2718
<b>18 AWG solid</b>			
U-XLPE/IS/OS/HIPK/SWA/LSZH			
1x2x18	6,5	12,2	416
2x2x18	10,0	15,9	698
4x2x18	11,5	17,7	1076
6x2x18	13,9	20,0	1299
12x2x18	18,4	24,9	2190
16x2x18	20,5	27,1	2594
24x2x18	25,5	32,5	3422
<b>16 AWG solid</b>			
U-XLPE/IS/OS/HIPK/SWA/LSZH			
1x2x16	7,6	13,4	467
2x2x16	12,0	18,1	780
4x2x16	14,1	20,3	1224
6x2x16	16,9	23,3	1503
12x2x16	22,7	29,3	2468
16x2x16	25,3	32,1	3160
24x2x16	31,8	39,8	4394

approximate values

Electrical Characteristics			
Cross section (AWG)	20	18	16
Capacitance (pF/m)	≤150	≤150	≤150
L/R (μH/Ohm)	≤25	≤25	≤25

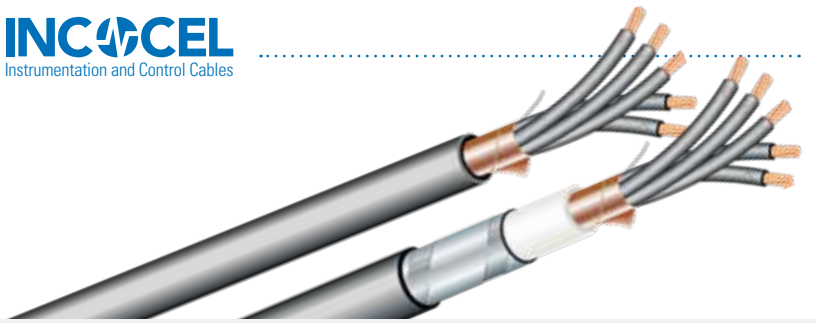

# CONTROL CABLES

## Multicore Overall Screen

### NOT ARMoured

XLPE/OSC/PVC  
XLPE/OSC/LSZH

### ARMoured

XLPE/OSC/PVC/GSTA/PVC  
XLPE/OSC/LSZH/GSTA/LSZH

### APPLICATIONS

Can be used to connect electric instruments and apparatus, for secondary switching of remote-control starters and regulators, for protective relaying and in automation.

### OPERATING TEMPERATURE

-20 °C to +80 °C (for general use);  
-40 °C to +90 °C (on request).

### MINIMUM BENDING RADIUS

#### Not armoured type

12 times the outer diameter (for conductors class 1 and class 2);  
10 times the outer diameter (for conductors class 5).

#### Armoured type

15 times the outer diameter.

### CABLE CONSTRUCTION

**Conductors** Plain annealed electrolytic copper wire according to EN 60228 class 1(U) solid, class 2 (R) stranded, class 5 (F) flexible.

**Insulation** XLPE, PVC, PE or LSZH thermoplastic material.

**Cabling** The insulated cores are cabled together, with suitable non hygroscopic fillers (when necessary) and wrapped with plastic tape if required.

**Overall screen** Copper/polyester tape, coverage >100%, copper in contact with tinned copper drain wire (Aluminium/polyester tape can be supplied as alternative).

#### Armoured

*Inner sheath: PVC or LSZH thermoplastic material.*

*Armour: GSTA - Double galvanized steel tape armour*

*(SWA - Steel wire armour can be supplied as alternative).*

**Outer sheath** PVC or LSZH thermoplastic material.

### APPLICABLE STANDARDS

*Basic design* 60502-1

*Flame retardant* 60332-1

*Fire retardant (cat. C or A according to requirements)* IEC 60332-3

*Halogen free properties (only for LSZH cables)* IEC 60754-1

*Low smoke emission (only for LSZH cables)* IEC 61034-2

### IEC 60502-1 (0.6/1 kV)

Cross section (mm <sup>2</sup> )	UNARMoured		ARMoured		
	Outer diameter (mm)	Weight (kg/km)	Diameter under armour (mm)	Outer diameter (mm)	Weight (kg/km)
1,5 mm <sup>2</sup> stranded	R-XLPE/OSC/PVC		R-XLPE/OSC/PVC/GSTA/PVC		
3x1.5	10,6	150	9,0	13,4	300
5x1.5	12,2	210	10,6	15,0	380
7x1.5	13,1	245	11,5	15,9	435
12x1.5	16,6	385	15,0	19,4	620
19x1.5	19,1	535	17,5	21,9	810
24x1.5	22,1	660	20,5	24,9	980
2,5 mm <sup>2</sup> stranded	R-XLPE/OSC/PVC		R-XLPE/OSC/PVC/GSTA/PVC		
3x2.5	11,4	180	9,8	14,2	325
5x2.5	13,3	260	11,7	16,1	470
7x2.5	14,4	345	12,8	17,2	530
12x2.5	18,4	535	16,8	21,2	770
19x2.5	21,1	765	19,5	23,9	1015
24x2.5	24,6	950	23,0	27,4	1265

approximate values

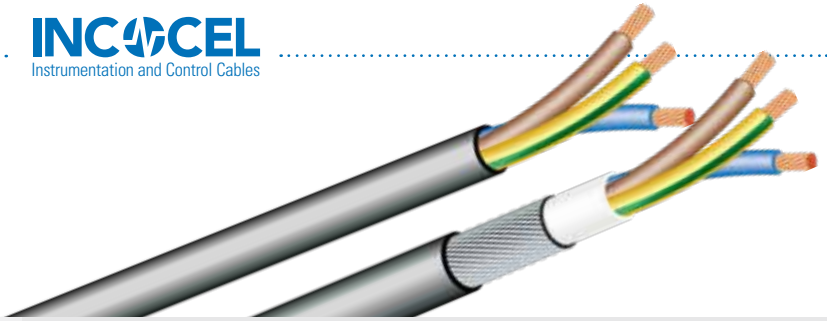

# POWER CABLES

## Multicore

### NOT ARMOURED

XLPE/PVC  
XLPE/LSZH

### ARMOURED

XLPE/PVC/SWA/PVC  
XLPE/LSZH/SWA/LSZH

### APPLICATIONS

Used for transmission of electrical power. They can be installed as permanent wiring within buildings, industrial plants, buried in the ground, run overhead, or exposed.

### OPERATING TEMPERATURE

-20 °C to +80 °C (for general use);  
-40 °C to +90 °C (on request).

### MINIMUM BENDING RADIUS

#### Not armoured type

12 times the outer diameter (for conductors class 2);  
10 times the outer diameter (for conductors class 5).

#### Armoured type

15 times the outer diameter.

### CABLE CONSTRUCTION

**Conductors** Plain annealed electrolytic copper wire according to EN 60228 class 2 (R) stranded, class 5 (F) flexible.

**Insulation** XLPE.

**Cabling** The insulated cores are cabled together, with suitable non hygroscopic fillers (when necessary) and wrapped with polyester tape if required.

#### Armoured

*Inner sheath: PVC or LSZH thermoplastic material.  
Armour: SWA - Single layer of galvanized steel wires  
(GSTA - Double galvanized steel tape can be supplied as alternative).*

**Outer sheath** PVC or LSZH thermoplastic material.

### APPLICABLE STANDARDS

*Basic design* 60502-1  
*Flame retardant* 60332-1  
*Fire retardant (cat. C or A according to requirements)*  
IEC 60332-3  
*Halogen free properties (only for LSZH cables)*  
IEC 60754-1  
*Low smoke emission (only for LSZH cables)*  
IEC 61034-2

### IEC 60502-1 (0.6/1 kV)

Cross section (mm <sup>2</sup> )	UNARMOURED		ARMOURED			Current rating in air at 30 °C (A)
	Outer diameter (mm)	Weight (kg/km)	Diameter under armour (mm)	Outer diameter (mm)	Weight (kg/km)	
stranded	R-XLPE/PVC		R-XLPE/PVC/SWA/PVC			
2x1.5	9.7	125	8.2	13.6	315	24
2x2.5	10.5	155	8.9	14.3	355	33
2x4	11.6	200	10.0	15.4	420	45
2x6	12.7	260	11.1	16.5	505	58
2x10	15.3	400	12.5	18.9	760	80
2x16	17.2	555	14.4	20.8	960	107
2x25	20.4	820	17.7	24.8	1435	142
2x35	22.5	1055	19.8	26.9	1730	175
2x50	25.0	1370	22.3	29.5	2120	212
2x70	28.9	1875	26.2	33.8	2785	270
2x95	32.5	2510	29.8	38.5	3795	327
2x120	37.0	3205	33.4	42.3	4570	379
2x150	40.8	3915	37.1	46.2	5410	435
2x185	44.7	4810	41.2	51.8	6935	496
3x1.5	10.2	145	8.6	14.0	345	22
3x2.5	11.0	185	9.6	14.9	390	30
3x4	12.2	240	10.7	16.0	475	40
3x6	13.4	315	11.9	17.2	570	52
3x10	16.1	485	13.5	19.7	865	71
3x16	18.1	685	15.5	21.7	1115	96
3x25	21.7	1030	19.2	26.1	1675	127
3x35	23.9	1330	21.4	28.4	2055	157
3x50	26.7	1740	24.2	31.3	2565	190
3x70	31.0	2425	28.8	36.9	3660	242
3x95	34.6	3260	32.2	40.8	4640	293
3x120	39.4	4145	36.2	45.0	5605	339
3x150	43.7	5085	40.6	50.8	7175	390
3x185	48.0	6270	44.7	55.1	8560	444
4x1.5	11.0	175	9.4	14.8	380	20
4x2.5	11.9	210	10.3	15.7	440	26
4x4	13.2	285	11.7	17.1	545	35
4x6	14.5	380	13.0	19.4	790	46
4x10	17.4	600	14.6	21	1010	63
4x16	19.7	850	17.0	24.1	1435	85
4x25	23.7	1275	21.0	28.2	1980	112
4x35	26.3	1675	23.5	30.9	2480	138
4x50	29.5	2215	26.6	34.2	3110	168
4x70	34.3	3090	31.6	40.5	4450	213
4x95	39.1	4210	35.6	44.7	5675	258
4x120	43.8	5305	40.3	50.9	7385	299
4x150	48.4	6480	44.6	55.5	8780	344
4x185	53.5	8060	49.2	60.5	10540	392
3X35/25	25.7	1570	22.9	30.1	2340	136
3X50/25	28.1	1960	25.4	32.7	2815	166
3X70/35	32.5	2720	30.0	38.7	4010	211
3X95/70	37.3	3725	33.7	42.6	5085	260
3X120/70	41.8	4735	38.1	47.4	6280	303
3X150/95	46.6	5900	42.8	53.4	8085	344
3X185/95	50.3	7050	46.4	57.4	9425	397

approximate values



**KNOW HOW  
AND EXPERTISE**

**ADVANCED TEST  
FACILITIES**

**RESEARCH  
AND DEVELOPMENT**

**PERFORMANCES**

## **CERTIFIED QUALITY**

INCOCEL cables are designed and manufactured according to relevant international standards and client specific requirements. Some of these requirements are industry standard whilst other specifications are custom requirements based on a project, environmental or other basis.

It is important for manufacturing bespoke cable to understand the standards, the client, as well as the influence plant and environmental conditions have on the materials used and the manufacturing processes.

It is important to verify compliance of the requirements once the cable has been manufactured. Hence, a qualified/specialized personnel in carrying out these checks, as well as advanced testing equipment are necessary. Cavicel has as fully equipped lab enabling it to carry out the required electrical, mechanical, chemical and functional tests.

The team conducting these tests are specialized and have the know-how experience to conduct these test to its best, following detailed Inspection and Testing Plans approved by our clients.

On top of the requirements detailed in the standards, depending on their use, cables have to withstand harsh environments and conditions:

**RESISTANCE TO EXTREME TEMPERATURES**

**RESISTANCE TO HUMIDITY**

**RESISTANCE TO CORROSIVE ENVIRONMENTS**

**RESISTANCE TO CHEMICAL ENVIRONMENTS**

**HIGH MECHANICAL RESISTANCE**

**HEALTH & SAFETY REQUIREMENTS:  
FIRE RESISTANCE AND FLAME RETARDANT**

**RESISTANCE AGAINST RODENTS AND TERMITES**

Cavicel Cables distinct itself from other manufacturers by performing to its best even in the harshest conditions.

***Reliability is our Specialty.***



**AGEING**

Cables are frequently installed in harsh environments having extremely low and high temperatures. It is therefore important that the materials used for the insulation and jacket for these cables are appropriate and that tests can be carried out at these temperatures to verify compliance.

▶ **Elongation test at low temperature**



▶ **Bending test at low temperature**



▶ **Ageing in hot air**



▶ **Thermal cycling**



▶ **Arrhenius Theory - Cable Life Time**

The lifetime of a cable is the result of a function of working temperature and time in use. It is possible to study and test a material, under specific conditions, to foresee its lifetime. Normally, the Arrhenius Theory is applied in which several tests are carried out at various temperatures for length of time to estimate its behavior with time.

Arrhenius theory is applied to determine the behavior of insulation materials depending on temperature and time. Arrhenius equation to study the chemical reaction rate is:

$$K = A e^{-E/RT}$$

where:

K = rate constant

A = constant

E = activation energy

R = Boltzman constant

T = absolute temperaturesse.

Results of Experimental Tests are plotted on a graph representing the behavior of a material and therefore estimate the life time of the product.

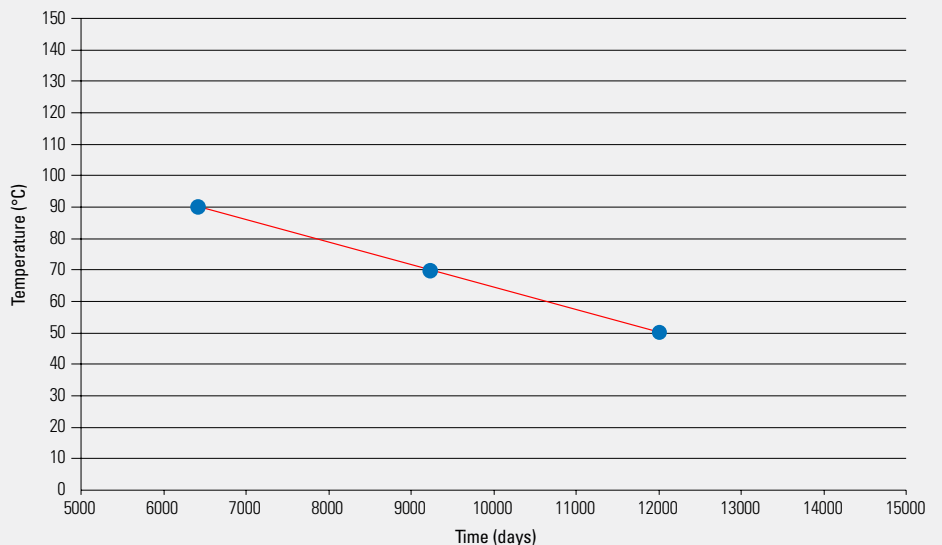

## HARSH ENVIRONMENTS



Cables installed, mainly in the Oil & Gas Industry, are subject to a number of aggressive chemical agents. For this reason, the materials used for cables in these installations are selected with care and are then tested in our laboratory to ensure their suitability.

### ► Ageing in Mineral Oil



### ► Ageing for MUD resistance (Drilling Fluid EDC 95-11 – NEK standard TS606)



### ► Ageing for MUD resistance (Calcium Bromide Brine – NEK standard TS606)



## MECHANICAL SHOCK RESISTANCE



Frequently cables are subject to mechanical forces, during installation and whilst in use. Because of this it is sometimes required that a cable can withstand certain requirements; torsion, traction, compression, bending and impact resistance. These applies to both copper and fiber optic cables.

### ► Compression test

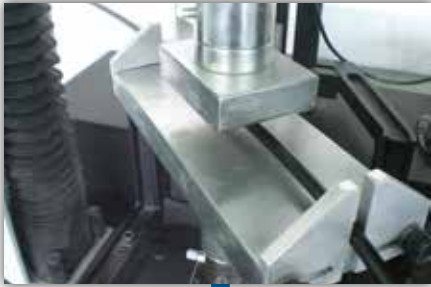

### ► Impact test



### ► Tensile Strength test



### ► Rodent and termite resistance

In some instances cables can be damaged by rodents, termites or other animals which can compromise the integrity of the cable and hence its performance. To protect the cable from this, these cables can have a metallic armor applied in different forms and materials; steel wire, steel braid, tape armor, etc. Anti-animal additives can also be added. Here too, it is important to be able to test their characteristics.



### ► Termite resistant test

No.	Sample Description	Weight Loss of Material due to Termite Feeding (%)			
		Replicate 1	Replicate 2	Replicate 3	Replicate 4
1	AT-treated cable (MLO-009-36(6)-M1/ NY/M1-A5-WB-FR)	0,3	0,7	0,0	0,3
2	Non AT-treated cable (FUTGCP008009)	0,9	1,0	1,9	1,3
3	Soft wood block	55,2	4,7	9,6	23,2
4	Tree branch	13,2	14,6	15,1	14,3

\*T-test statistical analysis between the AT-treated cable and non AT-treated cable gives a p-value of 0.08, which indicates that there is no significant difference in the repellency against termite feeding for the cables treated with and without the anti-rodent additive.



► **Crack Resistant Jacket**

During the last years some problems of cracking on Halogen Free Flame Retardant (HFFR) sheaths have been observed by main cables company, relative clients and contractors. Cables involved in this kind of inconvenience generally were stored or installed in projects in the Far East area where sometimes the direct exposition to sun causes an increase of surface temperature up to 70°C. The mechanical characteristics of HFFR sheathing compounds exposed for a long period at high temperature (from 50 to 70°C)

get radically worse: the material becomes soft, weak, and cracks more easily. Significant claims were made against cable suppliers requiring cable removal and replacement. This is why Cavicel decided to study the behavior of mechanical characteristics of different types of HFFR compound at high temperature and to set up some specific test to characterize the sheaths with specific experimental test.

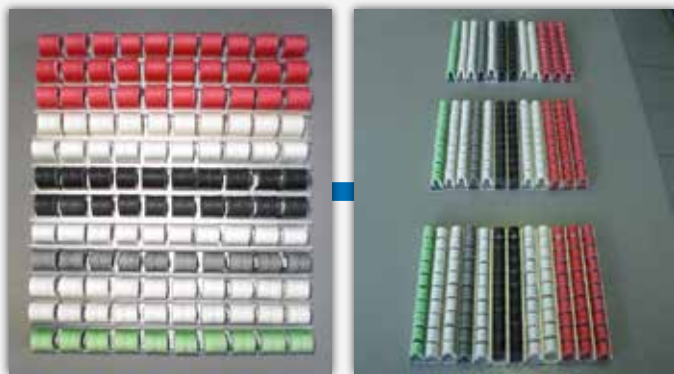

*Samples prepared for ageing in oven at different temperature.*



*Samples in oven at different temperature.*



*Samples after ageing*



*Stress bending test at high temperature with high grade compound*



*Stress bending test at high temperature with standard compound*

## FIRE PERFORMANCE TESTS



### ► Fire resistant tests

These tests verify the performance of the cable under conditions of a fire. This feature can be a paramount feature for cables used in Chemical and Petrochemical Installations to ensure a correct performance of safety systems, but also the plant in any situation, even the most critical. These requirements can differ from cable to cable and hence their test requirements.

BS EN 50200  
NS EN 50200 – Annex E  
BS 6387 CWZ  
BS 8434-2  
BS 8491  
IEC 30331-21/23/25  
NFC 32070 CR1



### ► Fire/Flame propagation tests

Flame retardant cables can resist the spread of fire, but the cable is fully consumed by the flame and no circuit integrity is assured. All the systems connected to these cables are disconnected. Flame retardant cables are not intended to assure service during a fire but are intended to prevent the flame spreading.

BS EN 60332-1  
BS EN 60332-2  
BS EN 60332-3  
IEC 60332-1  
IEC 60332-2  
IEC 60332-3





► **Gas emission test**

The victims of a fire aren't only subject to the hazard of the fire, but also due to the gases that are created and released from the burning of materials. Acid gas evolved from materials such as PVC can be dangerous to people and equipment's. This is why Low Smoke Zero Halogen (LSZH) material are preferred not only in closed space but also in critical plants. Specific tests are performed to measure the quantity of acid gas evolved during combustion of cables, and also measuring corrosiveness of gases released when cables burns, through PH and Conductivity.

BS EN 60754-1  
BS EN 60754-2  
IEC 60754-1  
IEC 60754-2



► **Smoke Density Test**

This test measures the intensity of the fumes created when burning a predetermined length of cable. The transmittance value recorded allows to ensure, that in case of a fire, a line of sight is maintained for a safer evacuation of the premises and easier intervention from the emergency services. Higher the transmittance value, the better visibility and line of sight.

BS EN61034-2  
IEC 61034-2

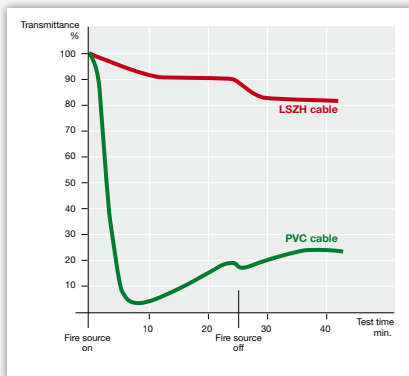

## MATERIALS

	Insulation	Sheath	Temperature range °C	Abrasion resistance	Oil resistance	Solvent resistance	Water resistance	Nuclear radiation resistance	Flame retardancy	Flexibility
PVC	•	•	-40 +105	●●●	●●●	●●	●●●	●●	●●●	●●●
Polyethylene	•	•	-40 +80	●●●	●●	●●●	●●●	●●	•	●●
Polypropylene	•		-40 +105	●●●	●●●	●●●	●●●	●●	•	●●
Nylon		•	-70 +120	●●●	●●●	●●●	●●	●●	•	●●
Polyurethane		•	-40 +80	●●●	●●●	●●	●●●	●●●	●●●	●●●
XLPE	•		-60 +90	●●	●●●	●●●	●●●	●●	•	●●
Fluoropolymer FEP	•	•	-80 +205	●●	●●●	●●●	●●●	•	●●●	●●
Fluoropolymer PTFE	•	•	-80 +260	●●	●●●	●●●	●●●	•	●●●	●●
Fluoropolymer PFA	•	•	-80 +260	●●	●●●	●●●	●●●	•	●●●	●●
Fluoropolymer MFA	•	•	-80 +240	●●	●●●	●●●	●●●	•	●●●	●●
Fluoropolymer ETFE	•	•	-80 +155	●●	●●●	●●●	●●●	●●●	●●●	•
Fluoropolymer ECTFE	•	•	-60 +160	●●●	●●●	●●●	●●●	●●●	●●●	●●
Hytrel®	•	•	-40 +80	●●●	●●●	●●●	●●●	•	•	●●
Peek®	•	•	-60 +250	●●	●●●	●●●	●●●	●●●	●●●	•
Kapton®	•	•	-75 +200	●●●	●●●	●●●	●●●	●●●	●●●	•
Technopolymer LSZH	•		-30 +90	●●	●●●	●●	●●●	●●●	●●●	●●
G10	•		-40 +90	●●	●●	•	●●●	●●●	●●●	●●●
Silicone Rubber	•	•	-60 +200	●●	●●	•	●●●	●●●	●●●	●●●
Thermoplastic Rubber		•	-55 +125	●●●	●●●	●●	●●●	•	●●●	●●●
Neoprene	•	•	-40 +90	●●●	●●●	●●	●●●	●●	●●●	●●●
EPR	•		-50 +90	●●●	●●	•	●●●	●●●	•	●●●
LSZH		•	-30 +90	●●	●●●	●●	●●●	●●●	●●●	●●

●●●● very good ●●● good ●● fair ● poor

This table is only a guide with main properties of materials. Materials used as insulation or jacket, can be defined in different way.

One is to use a general term, such as PVC. In this case the material is defined by his base polymer, but not the specific characteristic, such as temperature resistance, resistance to environment, flexibility, flame retardant properties...

Another way to define a material is to use standard code, for example type TM1 according to EN 50363, or LTS3 according to BS 7655. In this case all specific requirements of material are defined, but if additional requirements are necessary, these have to be specified (e.g. UV resistance).

The last way to define a material is to use abbreviations that define a specific characteristic, such as LSZH, that means Low Smoke Zero Halogen. In this case the behaviour in case of fire is specified but other characteristics of material are not pinpointed.

A last comment is related to other indication such as LSF: this means Low Smoke and Fume, but is too generic to define the type of material. This is why it is necessary to pay attention to the required product, to verify that all performances are clearly specified, and verify that manufacturer has considered all this to design the cables.

In CAVICEL our Technical Department is at your disposal to help you in the right choice.



## DESIGNATION SYSTEMS

### CAVICEL Code

Conductor	
U	solid plain copper wire to IEC 60228 class 1
R	stranded plain copper to IEC 60228 class 2
F	stranded plain copper wire to IEC 60228 class 5
U(*)	solid conductor different from plain copper
R(*)	stranded conductor different from plain copper
F(*)	flexible conductor different from plain copper

For copper conductor, please replace \* with:  
t = tinned - s = silver - n = nickel  
For thermocouple or compensating conductors, please replace \* with the first letter of calibration e.g.: K, J, T, W, etc.

Insulation / sheath	
PE	polyethylene
FPE	cellular polyethylene
HDPE	high density polyethylene
XLPE	cross-linked polyethylene
mXLPE	mica + cross-linked polyethylene
PVC	polyvinylchloride
EPR	ethylene-propylene rubber
SR	silicone rubber
TPE	thermoplastic rubber
HTE	heath resistant elastomer
LSZH	low smoke zero halogen compound
XLSZH	cross-linked low smoke zero halogen compound
ETFE	fluoropolymer for 150°C
FEP	fluoropolymer for 205°C
MFA	fluoropolymer for 230°C
PFA	fluoropolymer for 260°C
GTEX	glass braid

Shield	
IS	individual shield (aluminium/polyester) on individual pair/triad
ISC	individual shield (copper/polyester) on individual pair/triad
OS	overall shield (aluminium/polyester)
OSC	overall shield (copper/polyester)
ALPE	longitudinal aluminium tape bonded to PE or HDPE jacket
CWB	copper wire braid
TCWB	tinned copper wire braid
BCT	bare copper tape
TCT	tinned copper tape

Armour/protection	
LC	lead sheath
NC	nylon sheath
HIPK	Hi-Pack protection
SWA	steel wire armour
SFA	steel flat armour
GSWB	galvanized steel wire braid
GSTA	galvanized steel tape armour
SSWB	stainless steel wire braid
CST	corrugated steel tape

### Italian Standard

according to CEI-UNEL 35011

Conductor construction	
F	flexible copper conductor to IEC 60228 class 5
R	stranded copper conductor to IEC 60228 class 2
U	solid copper conductor to IEC 60228 class 1

Insulation or sheath	
E	polyethylene
E4	XLPE cross-linked polyethylene
G4	silicone rubber
G5	ethylene-propylene rubber based compound
G10	cross-linked low smoke zero halogen insulation compound
R	70°C PVC general use
R2	70°C PVC insulation type R2 to CEI 20-11 w
R5F	FEP fluoropolymer
R5M	MFA fluoropolymer
R5P	PFA fluoropolymer
R7	90° PVC
M1	low smoke zero halogen thermoplastic compound

Screen	
H	aluminium tape screen
H1	copper tape or copper wire spiral screen
H2	copper wire braid
H5	longitudinal aluminium tape bonded to a sheath

Metallic protection	
A	galvanized steel wire braid armour
F	steel wire armour
L	lead alloy sheath
N	galvanized steel tape armour
P	lead sheath
Z	steel flat wire armour

Cable shape	
O	external round shape
D	external flat shape
X	cores twisted

### German Standard

Cable type	
RE-	instrumentation cable
RT-	thermocouple cable
RAGL-	compensating cable for thermocouple
J-	installation cable
JE-	industrial electronic cable
RD-	control system cable

Conductor construction	
Li	stranded
f	flexible
e	single wire, solid
re-	round, single wire
rm-	round, multiwire

Insulation or sheath	
2G	silicone rubber
3G	ethylene-propylene rubber based compound
H	halogen free compound
HX	cross-linked halogen free compound
Y	PVC compound
Yu	PVC, flame retardant compound
Yö	PVC oil resistant
Yw	90°C PVC compound
2Y	polyethylene
2X	XLPE cross-linked polyethylene
4Y	polyamide
6Y	FEP fluoropolymer
7Y	ETFE fluoropolymer
8Y	polyimid Kapton®
11Y	polyurethan
14Y	PFA fluoropolymer

Screen	
(L)2Y	laminated sheath of aluminium tape plus polyethylene sheath
(ST)	collective screen
C	copper wire braid screen
PiMF	single pair screened with metal tape plus drain wire
TiMF	single triad screened with metal tape plus drain wire

Metallic protection	
M	lead sheath
Mz	lead alloy sheath
Q	steel wire braid armour
B	steel tape armour
R	steel wire armour
RG	steel wire armour with counterspiral tape
FG	steel flat wire armour with counterspiral tape

## DRUMS

DIMENSIONS AND WEIGHT												
DRUMS			06	07	08	09	10	12	14	16	18	20
D	Diameter	(mm)	650	750	840	940	1030	1280	1460	1660	1860	2060
L	Width	(mm)	450	500	600	550	660	730	850	1010	1350	1400
	Staved Drum Weight	(kg)	22	25	37	41	55	81	130	210	325	390
	Shipping Volume	(m <sup>3</sup> )	0,19	0,28	0,42	0,48	0,70	1,19	1,81	2,78	4,67	5,94

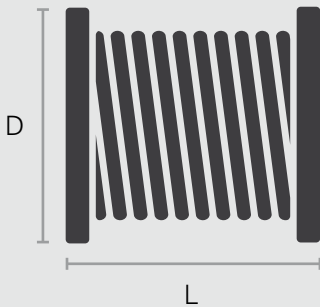

Drums are manufactured from timber in accordance with the International Plant Protection Convention (IPPC), adopted by the FAO (ISPM 15).

MAX LENGTH (m) PER DRUM TYPE												
DRUMS			06	07	08	09	10	12	14	16	18	20
Cable diameter (mm)												
	4		3830									
	6		1700	2770	3960	5000						
	8		930	1560	2240	2820	4340					
	10		580	960	1440	1780	2800	4900				
	12		420	660	970	1250	1950	3530	5340			
	14		290	460	720	950	1410	2650	3860			
	16		190	370	520	710	1070	1950	2890	4170		
	18		150	250	420	530	800	1550	2310	3330	4550	
	20		110	200	330	420	660	1190	1830	2650	3850	4570
	22		100	180	260	330	530	990	1460	2040	2980	3820
	24			130	200	260	430	760	1260	1740	2530	3050
	26			100	160	210	340	630	1020	1460	2170	2630
	28				150	200	280	580	860	1250	1830	2240
	30				110	150	250	490	740	1060	1520	1880
	32				100	140	200	390	610	880	1280	1600
	34					110	180	370	580	810	1170	1470
	36					100	140	300	460	680	990	1260
	38						130	280	440	630	790	1140
	40						130	220	350	510	770	1000
	42							220	330	490	710	790
	44							200	280	390	570	760
	46							150	260	370	550	730
	48							150	240	350	520	580
	50							140	190	350	400	560

# RECOMMENDATION FOR HANDLING AND STORAGE

## HANDLING AND STORAGE

When handling drums, reasonable precautions should be taken to avoid damage to the cable and injury to people. Due regard should be paid to the mass of the drum, the method and direction of rolling and the method of lifting.

Cable drums should be stored so that the drum flanges do not contact cable on another drum.

Cables stored at temperatures which are below those recommended for installation conditions, should not be subjected to any mechanical stress including shocks, impact, bending and torsion.

If cables are not fully protected (with battens or plastic foils for example), store should be in a protected area and not weather-beaten. The cable end should be sealed to prevent ingress of moisture during transport and storage.

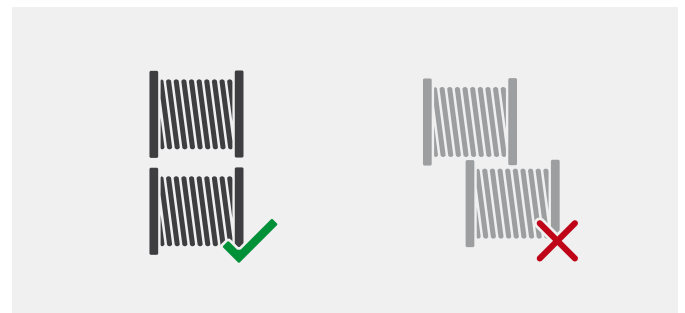
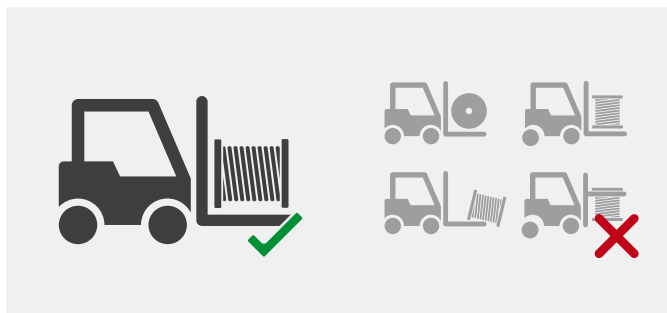
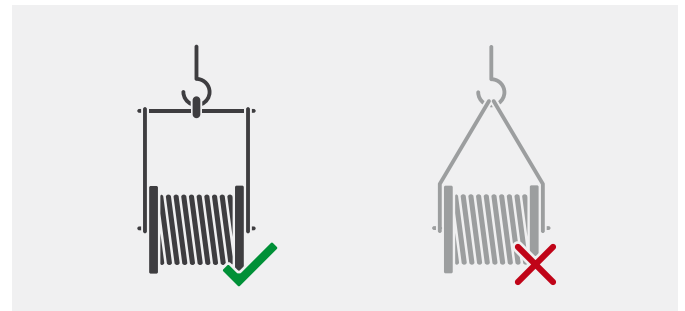

## UNWINDING

To unwind cables during installation, please refer to following pictures.

Battens, where applied, should not be removed from drums until the cables are to be installed. Care should be taken to avoid injury with nails when removing battens.

To remove possible plastic foil on cable, do not use sharp tools that could damage cable jacket.

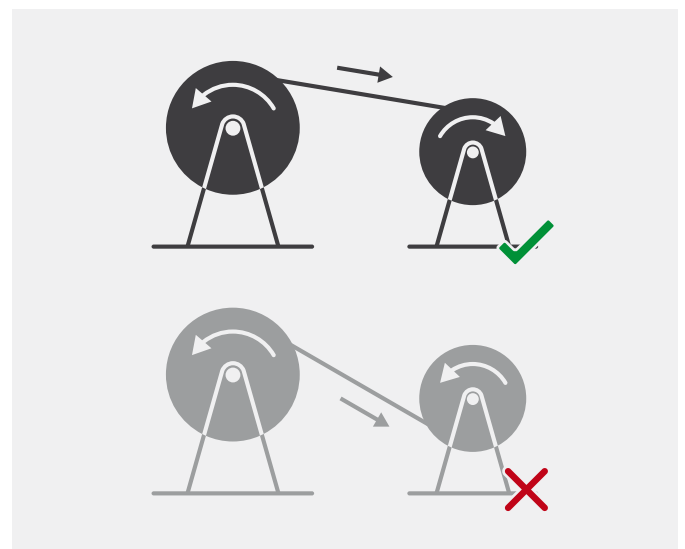
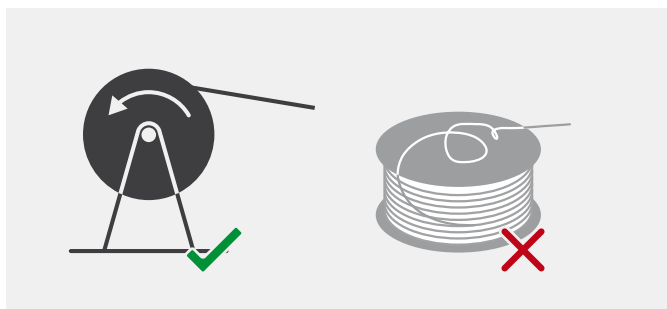



Conducting Value

.....  
**CAVICEL SpA**

Via Caduti del Lavoro, 18/A  
20096 Pioltello (Milano)

Italy

ph. +39 - 02 - 921.605.21

fax +39 - 02 - 921.607.53

e-mail: cavicel@cavicel.com  
.....

**CAVICEL SPA (DMCC BRANCH)**

Fortune Executive Tower

Office 406 - Plot No. T1

Jumeirah Lakes Towers

Dubai - UAE - PO Box 634377

ph. +971 4.4581199

fax +971 4.4581144

e-mail: middleeast@cavicel.com  
.....

**DUBAI BRANCH OFFICE**

.....  
**HONG KONG OFFICE**

2/F, AXA Southside Building

38 Wong Chuk Hang Road

Hong Kong

Ph: +852 3963 9365

e-mail: apac@cavicel.com  
.....

www.cavicel.com



**MADE IN ITALY**



Cavicel firmly believes in the importance of the quality of its products and it undertakes itself to produce them using clean technologies for the respect and the protection of the environment.

All information contained in this brochure is believed to be accurate. Specifications can change at any time, according to technical developments and market changes.

All rights reserved. No part of this document may be reproduced in any form or by any means, without the prior written permission from Cavicel SpA.