

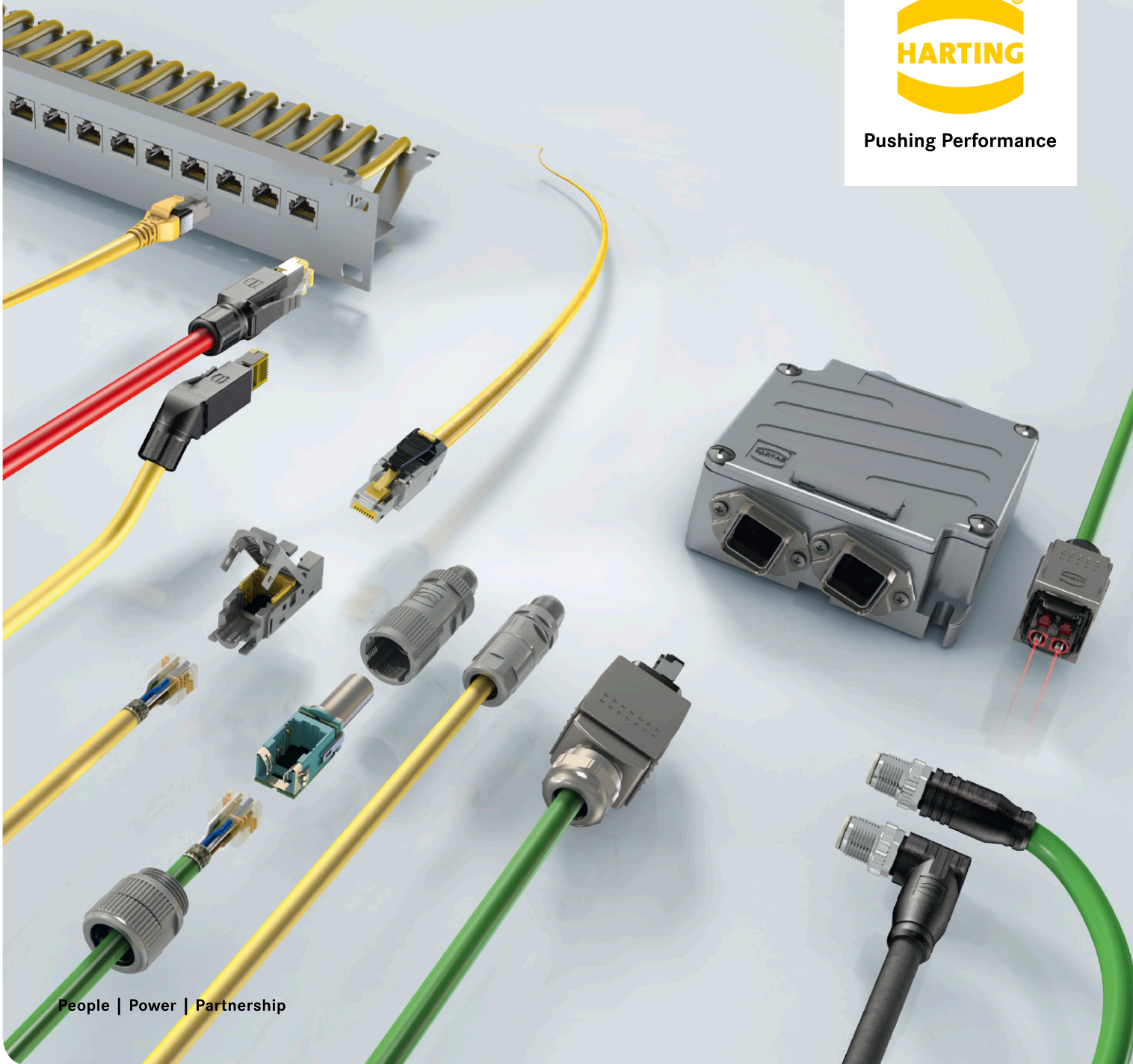

Pushing Performance



People | Power | Partnership

HARTING Ethernet Cabling
Data Communication Networks for the Industry,
Automation and Transportation

Transforming customer wishes into concrete solutions



The HARTING Technology Group is skilled in the fields of electrical, electronic and optical connection, transmission and networking technology, as well as in manufacturing, mechatronics and software creation. The Group uses these skills to develop customized solutions and products such as connectors for energy and data-transmission/data-networking applications, including, for example, mechanical engineering, rail technology, wind energy plants, factory automation and the telecommunications sector. In addition, HARTING also produces electro-magnetic components for the automobile industry and offers solutions in the field of housing technology and shop systems.

The HARTING Group currently comprises 57 sales companies and production plants worldwide employing a total of about 4,600 staff.

We aspire to top performance.

Connectors ensure functionality. As core elements of electrical and optical termination, connection and infrastructure technologies, they are essential in enabling the modular construction of devices, machines and systems across an extremely wide range of industrial applications. Their reliability is a crucial factor guaranteeing smooth functioning in the manufacturing area, telecommunications, applications in medical technology – in short, connectors are at work in virtually every conceivable application area. Thanks to the ongoing development of our technologies, our customers enjoy investment security and benefit from durable, long-term functionality.

Wherever our customers are, we're there.

Increasing industrialization is creating growing markets that are characterized by widely diverging demands and requirements. What these markets all share in common is the quest for perfection, increasingly efficient processes and reliable technologies. **HARTING** is providing these technologies – in Europe, the Americas and Asia. In order to implement customer requirements in the best possible manner, the **HARTING** professionals at our international subsidiaries engage in up-close, partnership-based interaction with our customers, right from the very early product development phase.

Our on-site staff form the interface to the centrally coordinated development and production departments. In this way, our customers can rely on consistently high, superior product quality – worldwide.

Our claim: Pushing Performance.

HARTING provides more than optimally attuned components. In order to offer our customers the best possible solutions, on request **HARTING** contributes a great deal more and is tightly integrated into the value-creation process.

From ready-assembled cables through to control racks or ready-to-go control desks. Our aim is to generate maximum benefit for our customers – with no compromises!

Quality creates reliability – and warrants trust.

The **HARTING** brand stands for superior quality and reliability – worldwide. The standards we set are the result of consistent, stringent quality management that is subject to regular certifications and audits.

EN ISO 9001, the EU Eco-Audit and ISO 14001 are key elements here. We take a proactive stance towards new requirements, which is why **HARTING** is the first company worldwide to have obtained the IRIS quality certificate for rail vehicles.



HARTING technology creates added value for customers.

Technologies by **HARTING** are at work worldwide. **HARTING**'s presence stands for smoothly functioning systems powered by intelligent connectors, smart infrastructure solutions and sophisticated network systems. Over the course of many years of close, trust-based cooperation with its customers, the **HARTING** Technology Group has become one of the leading specialists globally for connector technology. We offer individual customers specific and innovative solutions that go beyond the basic standard functionalities. These tailored solutions deliver sustained results, ensure investment security and enable customers to achieve significant added value.

Opting for HARTING opens up an innovative, complex world of concepts and ideas.

In order to develop and produce connectivity and network solutions serving an exceptionally wide range of connector applications in a professional and cost-effective manner, **HARTING** not only commands the full array of conventional tools and basic technologies. Above and beyond these capabilities, **HARTING** is constantly harnessing and refining its broad base of knowledge and experience to create new solutions that also ensure continuity. To secure its lead in know-how, **HARTING** draws on a wealth of sources from its in-house research and applications.

Salient examples of these sources of innovative knowledge include microstructure technologies, 3D design and connection technology,

high-temperature and ultrahigh-frequency applications that are finding use in telecommunications and automation networks, in the automotive industry, or in industrial sensor and actuator applications, RFID and wireless technologies, in addition to packaging and housing made of plastics, aluminium and stainless steel.

HARTING overcomes technological limitations.

Drawing on the comprehensive resources of the group's technology pool, **HARTING** devises practical solutions for its customers. Whether this involves industrial networks for manufacturing automation, or hybrid interface solutions for wireless telecommunication infrastructures, 3D circuit carriers with microstructures, or cable assemblies for high-temperature applications in the automotive industry - **HARTING** technologies offer not only components, but comprehensive solutions attuned to individual customer requirements and preferences. The range of cost-effective solutions covers ready-to-use cable configurations, completely assembled backplanes and board system carriers, as well as fully wired and tested control panels.

In order to ensure the future-proof design of RF and EMC-compatible interface solutions, the central **HARTING** laboratory (accredited according to DIN EN ISO/IEC 17025) employs simulation tools, as well as experimental, testing and diagnostics facilities all the way to Industrial computed tomography. In addition to product and process suitability considerations, lifecycle and environmental aspects play a key role in the selection of materials and processes.

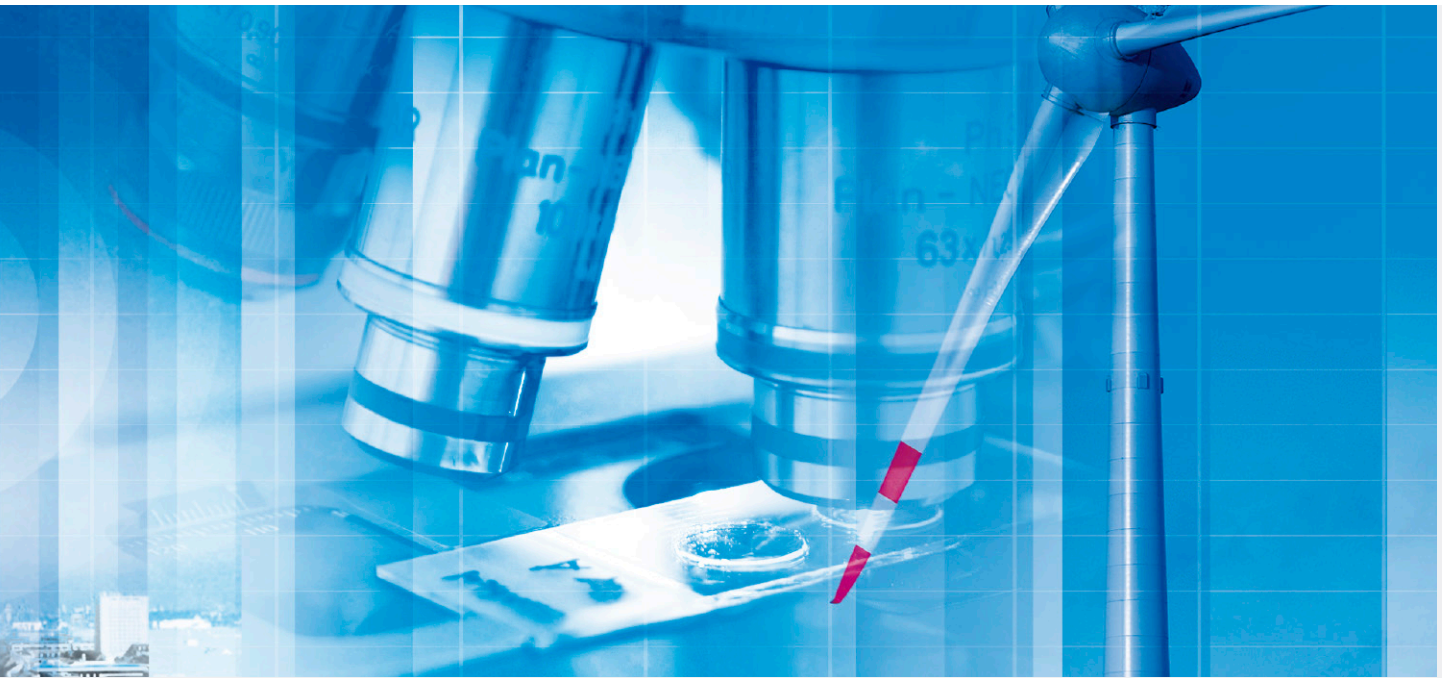

HARTING's knowledge is practical know-how that generates synergy effects.

HARTING commands decades of experience with regard to the applications conditions involved in connections in telecommunications, computer, network and medical technologies, as well as industrial automation technologies, e.g. in the mechanical engineering and plant engineering areas, in addition to the power generation industry and the transportation sector. HARTING is

highly conversant with the specific application areas in all of these technology fields. In every solution approach, the key focus is on the application. In this context, uncompromising, superior quality is our hallmark. Every new solution found invariably flows back into the HARTING technology pool, thereby enriching our resources. And every new solution we go on to create will draw on this wealth of resources in order to optimize each and every individual solution. HARTING is synergy in action.

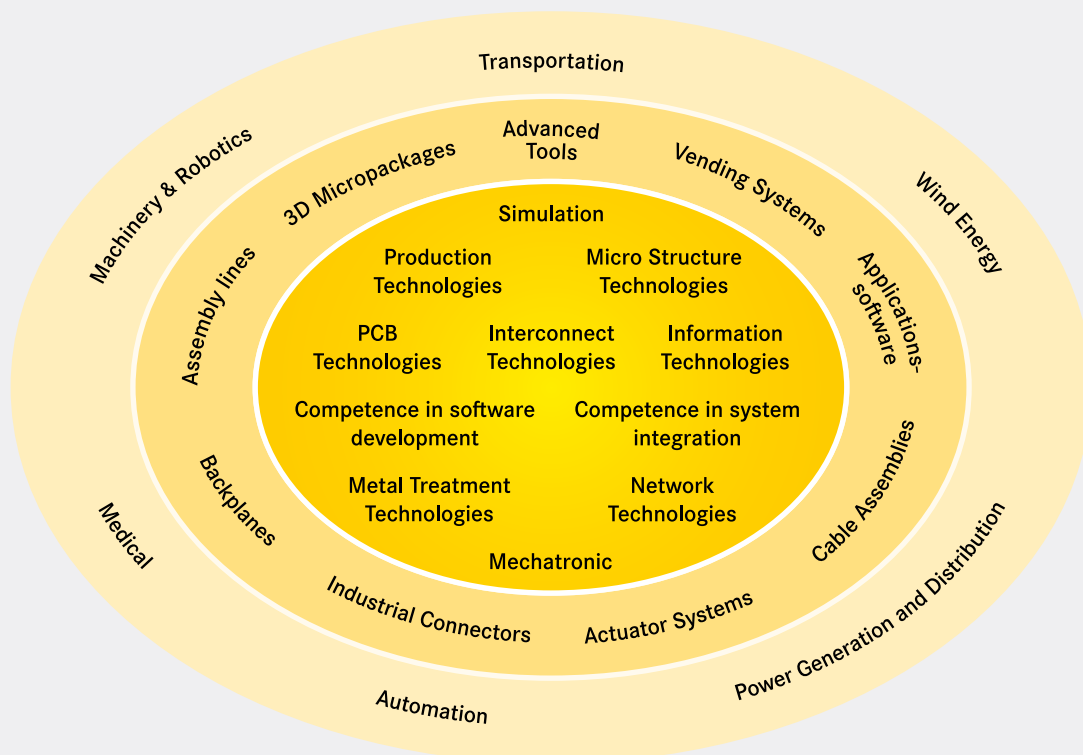



The **HARTING eCatalogue/eShop** can be found on our homepage at www.HARTING.com or at the direct link www.eCatalogue.HARTING.com.

The HARTING e-Catalogue is your platform for conveniently selecting individual products as well as configuring complete solutions. Our comprehensive product pages provide you with all necessary technical information and CAD files in various formats for downloading. You may also contact our technical sales department directly.

Find out about **product innovations and news** on the start page of the HARTING e-Catalogue or go directly to www.product-news.HARTING.com.

Registered users can take advantage of MyHARTING to check on availability or prices, and to place or track their orders. Here, your customized "HARTING history" provides you with a list of your inquiries, quotations and more.

Sign up now for your free e-Catalogue account at HARTING!

www.eShop.HARTING.com

Product samples: Fast-track delivery to your desk, free of charge

The new free express sample service in the HARTING eCatalogue allows customers to order samples immediately, easily and completely free of charge. A broad selection from the device connectivity product portfolio is now available. If a product is unavailable, the system offers alternative products with similar features that can be requested at a mouse click.

The free samples are shipped within 24 hours at no cost to you. This service enables tremendous flexibility, especially in the design phase of projects.

General information

It is the customer's responsibility to check whether the components illustrated in this catalogue also comply with different regulations from those stated in special fields of applications.

We reserve the right to modify designs or substance of content in order to improve quality, keep pace with technological advancement or meet particular requirements in production.

No part of this catalogue may be reproduced in any form (print, photocopy, microfilm or any other process) or processed, duplicated or distributed by means of electronic systems without the prior written consent of HARTING Electronics GmbH, Espelkamp. We are bound by the German version only.

Directory

Chapter

System cables, patch and connection cords

01

Data cables

02

Connecting hardware

03

Connectors for food and beverage

04

Cables and connectors for railway applications

05

Fibre optic cables and connectors

06

This catalogue covers data network cabling for Ethernet in accordance with IEEE802.3.

These support all commonly used Ethernet transmission speeds:

Fast Ethernet with 100 Mbit/s, Gigabit Ethernet and 10 Gbit/s Ethernet for future applications.

PoE (Power over Ethernet) is supported (with up to 15.4 W in compliance with IEEE802.3af, and up to 25.5 W in compliance with IEEE802.3at) so that devices can be supplied with power through their Ethernet cables.

In order to make it easier for our customers to use HARTING cabling solutions and components in their applications, we have special solutions for:

- Automation technology, machine and systems engineering, robotics and other industrial applications
- F+B (food and beverage industry)
- Railway and transportation systems (e.g. bus, tram, metro)

Many of the products listed here can also be used for structured building cabling because the HARTING data networking components and systems are standard-compliant.

HARTING focuses on industrial and industry-related applications. We are working, together with our partner ZVK GmbH (www.zvk-gmbh.de), on the interfaces between facilities, machines and buildings. ZVK focuses on the building cabling itself.

HARTING's solutions are designed, tested and certified for the entire industry.

So IPx protection, mating reliability, robustness, vibration resistance and EMC safety are all critical factors.

For all automation applications, compatibility with the corresponding automation profiles according to IEC 61784-5 and the associated cabling guidelines, is guaranteed.

The safety/fire tests according to EN 45 545/DIN 5510, UL 1685 and other specific or national standards are also taken into account for our railway cabling solutions.

You can find more details in the product-specific pages, the product data sheets and the test reports (available on request separately).

To ensure optimal performance of all cabling components (cable, connector, coupling, etc.), our components are tested according to the internationally established limits for Category 5/5e (100 MHz), Category 6 (250 MHz), 6A (500 MHz), Category 7 (600 MHz) and Category 7A (1 000 MHz).

These limits, along with the individual product standards, can be found in the current cabling standards: ISO/IEC 11 801 (valid internationally) and EN 50173 (valid throughout Europe).

The American standards for data network components and cabling (according to TIA/EIA 568x) mostly follow the ISO/IEC 11 801. They are, however, less strict in regards to certain limits (e.g. NEXT).

Thus, all cabling components tested in accordance with ISO/IEC 11801 also comply with the limits from TIA/EIA 568x.

After the entire cable path has been installed, the user can check his channel transmission performance according to the transmission classes (Class D up to 100 MHz, Class E to 250 MHz, Class EA to 500 MHz and Class F to 600 MHz).

The entire cabling, however, must be installed before this inspection can take place. The installation instructions supplied must also be carefully followed.

HARTING also provides bus cables with 120 Ω for MVB and WTB applications and the corresponding connectors to supplement our railway cabling product portfolio.

(MVB = Multifunction Vehicle Bus, WTB = Wire Train Bus; both bus systems are still widely in use but are increasingly being replaced by Ethernet).

All HARTING components have been designed, manufactured and tested in their particular installation environments to ensure their transmission speeds, performances, mating reliability and long-term stability.

Thus, our users can rely on a complete, powerful and proven portfolio of HARTING cabling components that precisely match their needs.

More technical information, references to the international body of standards, as well as useful information and explanations can be found on the pages and chapters to follow.

Directory Chapter 01

Page

General information	01.02
RJ cords, 4-wire	
HARTING RJ Industrial® system cable, straight	01.04
HARTING RJ Industrial® system cable, angled	01.06
preLink® system cable	01.12
Han® PushPull RJ45 system cable	01.14
Han® 3 A RJ45 system cable	01.16
Han® 3 A RJ45 Hybrid system cable	01.20
RJ cords, 8-wire	
PROFINET cabinet cord	01.23
HARTING RJ Industrial® patch cable, overmoulded	01.24
Patch cable RJ45 DualBoot®, shielded	01.28
PushPull patch cable RJ45 DualBoot®, shielded	01.30
preLink® patch cable	01.34
HARTING ix Industrial® system cable	01.36
Han® PushPull RJ45 system cable	01.38
Han® 3 A RJ45 system cable	01.39
Han® 3 A RJ45 Hybrid system cable	01.41
HARTING PushPull RJ45 system cable	01.43
M12 cords, 4-wire	
System cable with D-coding	01.46
M12 cords, 8-wire	
System cable with X-coding	01.49

Connector assignment

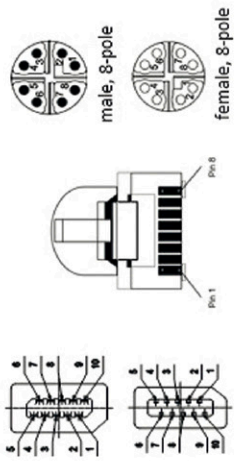
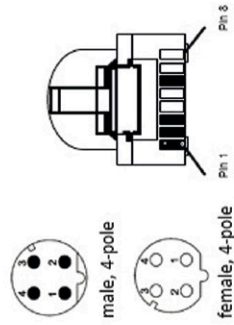

ix Industrial ix Industrial	1	2	6	4	5	7	9	10	*3,8=GND
RJ45	1	2	3	4	5	6	7	8	
M12 X-coded	1	2	3	8	7	4	5	6	
1 GBASE-T 2,5 GBASE-T 5 GBASE-T 10 GBASE-T	BL_DA+	BL_DA-	BL_DB+	BL_DC+	BL_DC-	BL_DB-	BL_DD+	BL_DD-	
EIA/TIA T568 A	white/green	green	white/orange	blue	white/blue	orange	white/brown	brown	
EIA/TIA T568 B	white/orange	orange	white/green	blue	white/blue	green	white/brown	brown	
ETHERNET/IP (2 pairs)	white/orange	orange	white/green			green			
PROFINET	yellow	orange	white			blue			
10BASE-T 100BASE-TX	TX+	TX-	RX+			RX-			
M12 D-coded M8 D-coded	1	3	2			4			
RJ45 4-pole	1	2	3			6			

All pre-assembled copper cables supporting Fast Ethernet, Gigabit Ethernet or 10 Gigabit Ethernet are listed in the HARTING system cables/cords chapter.

Specifically, these are:

- Four-wire system cables for Fast Ethernet (Category 5 for 100 Mbit/s)
- Eight-wire system cables for Gigabit Ethernet (according to Category 5e or Category 6 for 1 Gbit/s, and Category 6_A or Category 7 for 10 Gbit/s)

RJ45 and M12 system cables have standardised transmission characteristics.

All system cables manufactured by HARTING have been designed, constructed and tested according to these standards.

Our users are ensured of outstanding safety levels when using HARTING system cables in their facilities.

The following exceptions should be noted:

- System cables (also sometimes referred to as patch cables, connecting cables or cabinet cables) are limited to 10 metres. If the system cables need to be longer than 10 metres, then the transmission characteristics must be calculated and checked according to the relevant category formulas.

For simplicity's sake, transmission classes are often used as the basis for making this check. This is a legitimate method; however, in extreme cases this means that long system cords must be tested within the facility cabling.

- System cables are only defined as an RJ45 male plug – cable – RJ45 male plug combination. Since users often need other combinations in the real world, HARTING has expanded its system cabling portfolio.

This includes combinations such as male plug – cable – female socket or custom constructions such as male plug – cable – preLink® terminating block.

To ensure quality and performance, HARTING has established relevant limit values and measurement methods which are often not yet adequately represented in the standards.

- Many industrial, railway or telecommunications applications require customised designs to achieve durable yet cost-effective solutions. Such customised solutions are provided by the GBU HCS.

(HCS = HARTING Customised Solutions)

<http://www.HARTING-customised-solutions.com/en/home/>



HARTING RJ Industrial®
system cable, 4-wire, straight, Cat. 5

RJ45 cords

Features

- Connector types RJ45
- Category Cat. 5
- Number of wires 4
- Wiring 1:1
- Sheath material PVC/PUR

Application

- Industrial Cabling
- Within switch cabinets
- On machines and control units

Benefits

- Transmission of up to 100 Mbit/s
- Very robust RJ45 cord
- Large temperature range
- Locking lever protection
- PROFINET compliant
- Useable as trailing cable (type C)

Technical characteristics

- Connector types RJ45 overmoulded and locking lever protection
- Cable type 4 x AWG 22/7, Cat. 5, Star quad, double shielding
- Sheath material
 - Type B PVC
 - Type C PUR
- Wiring 4 pole, contacts 1/2 and 3/6
- Transmission performance Category 5 class D up to 100 MHz acc. to ISO/IEC 11801, EN 50173-1
- Transmission rate 10/100 Mbit/s
- Shielding Fully shielded, 360° shielding contact
- Operating temperature range -25 °C ... +60 °C
- Colour Green (PROFINET), Red (SERCOS III)



Identification	Part number	
	Profinet	SERCOS III
HARTING RJ system cable, compact 4-wire Type B		
Length 0.5 m	09 48 686 8001 005	09 48 686 8006 005
1.0 m	09 48 686 8001 010	09 48 686 8006 010
1.5 m	09 48 686 8001 015	09 48 686 8006 015
3.0 m	09 48 686 8001 030	09 48 686 8006 030
5.0 m	09 48 686 8001 050	09 48 686 8006 050
7.5 m	09 48 686 8001 075	09 48 686 8006 075
10.0 m	09 48 686 8001 100	09 48 686 8006 100
15.0 m	09 48 686 8001 150	09 48 686 8006 150
20.0 m	09 48 686 8001 200	09 48 686 8006 200
HARTING RJ system cable, compact 4-wire Type C		
Length 0.5 m	09 48 686 8004 005	09 48 686 8007 005
1.0 m	09 48 686 8004 010	09 48 686 8007 010
1.5 m	09 48 686 8004 015	09 48 686 8007 015
3.0 m	09 48 686 8004 030	09 48 686 8007 030
5.0 m	09 48 686 8004 050	09 48 686 8007 050
7.5 m	09 48 686 8004 075	09 48 686 8007 075
10.0 m	09 48 686 8004 100	09 48 686 8007 100
15.0 m	09 48 686 8004 150	09 48 686 8007 150
20.0 m	09 48 686 8004 200	09 48 686 8007 200

Other cable lengths on request



HARTING RJ Industrial®
system cable, 4-wire, angled, Cat. 5

RJ45 cords

Features

- Connector types RJ45
- Category Cat. 5
- Number of wires 4
- Wiring 1:1
- Sheath material PVC/PUR

Application

- Industrial Cabling
- Within switch cabinets
- On machines and control units

Benefits

- Transmission of up to 100 Mbit/s
- Very robust RJ45 cord
- Very large temperature range
- Locking lever protection
- PROFINET compliant
- Useable as trailing cable (type C)

Technical characteristics

- Connector types RJ45 overmoulded and locking lever protection
- Cable type 4 x AWG 22/7, Cat. 5, Star quad, double shielding
- Sheath material
 - Type A PVC
 - Type B PVC
 - Type C PUR
- Wiring 4 pole, contacts 1/2 and 3/6
- Transmission performance Category 5 class D up to 100 MHz acc. to ISO/IEC 11801, EN 50 173-1
- Transmission rate 10/100 Mbit/s
- Shielding Fully shielded, 360° shielding contact
- Operating temperature range -40 °C ... +70 °C
- Colour Green (PROFINET)
Black (PROFINET Outdoor)



Identification	Part number	
<p>HARTING RJ Industrial® system cable, angled, 4-wire Type A, angled left to angled right</p> <p style="text-align: right;">Length 0.5 m 1.0 m 1.5 m 2.0 m 3.0 m 5.0 m</p>	<p>09 47 050 6001 09 47 050 6002 09 47 050 6003 09 47 050 6004 09 47 050 6005 09 47 050 6007</p>	
<p>HARTING RJ Industrial® system cable, angled, 4-wire Type B, angled left to angled right</p> <p style="text-align: right;">Length 0.5 m 1.0 m 1.5 m 2.0 m 3.0 m 5.0 m</p>	<p>09 47 050 6023 09 47 050 6024 09 47 050 6025 09 47 050 6026 09 47 050 6027 09 47 050 6029</p>	
<p>HARTING RJ Industrial® system cable, angled, 4-wire Type C, angled left to angled right</p> <p style="text-align: right;">Length 0.5 m 1.0 m 1.5 m 2.0 m 3.0 m 5.0 m</p>	<p>09 47 050 6045 09 47 050 6046 09 47 050 6047 09 47 050 6048 09 47 050 6049 09 47 050 6051</p>	
<p>HARTING RJ Industrial® system cable, angled, 4-wire Type B, outdoor, angled left to angled right</p> <p style="text-align: right;">Length 0.5 m 1.0 m 1.5 m 2.0 m 3.0 m 5.0 m</p>	<p>09 47 050 6067 09 47 050 6068 09 47 050 6069 09 47 050 6070 09 47 050 6071 09 47 050 6073</p>	

Other cable lengths on request



HARTING RJ Industrial®
system cable, 4-wire, angled, Cat. 5

RJ45 cords

Features

- Connector types RJ45
- Category Cat. 5
- Number of wires 4
- Wiring 1:1
- Sheath material PVC/PUR

Application

- Industrial Cabling
- Within switch cabinets
- On machines and control units

Benefits

- Transmission of up to 100 Mbit/s
- Very robust RJ45 cord
- Very large temperature range
- Locking lever protection
- PROFINET compliant
- Useable as trailing cable (type C)

Technical characteristics

- Connector types RJ45 overmoulded and locking lever protection
- Cable type 4 x AWG 22/7, Cat. 5, Star quad, double shielding
- Sheath material
 - Type A PVC
 - Type B PVC
 - Type C PUR
- Wiring 4 pole, contacts 1/2 and 3/6
- Transmission performance Category 5 class D up to 100 MHz acc. to ISO/IEC 11801, EN 50 173-1
- Transmission rate 10/100 Mbit/s
- Shielding Fully shielded, 360° shielding contact
- Operating temperature range -40 °C ... +70 °C
- Colour Green (PROFINET)
Black (PROFINET Outdoor)



Identification	Part number	
<p>HARTING RJ Industrial® system cable, angled, 4-wire Type A, angeld top to angled bottom</p> <p>Length 0.5 m 1.0 m 1.5 m 2.0 m 3.0 m 5.0 m</p>	<p>09 47 030 4001 09 47 030 4002 09 47 030 4003 09 47 030 4004 09 47 030 4005 09 47 030 4007</p>	
<p>HARTING RJ Industrial® system cable, angled, 4-wire Type B, angeld top to angled bottom</p> <p>Length 0.5 m 1.0 m 1.5 m 2.0 m 3.0 m 5.0 m</p>	<p>09 47 030 4023 09 47 030 4024 09 47 030 4025 09 47 030 4026 09 47 030 4027 09 47 030 4029</p>	
<p>HARTING RJ Industrial® system cable, angled, 4-wire Type C, angeld top to angled bottom</p> <p>Length 0.5 m 1.0 m 1.5 m 2.0 m 3.0 m 5.0 m</p>	<p>09 47 030 4045 09 47 030 4046 09 47 030 4047 09 47 030 4048 09 47 030 4049 09 47 030 4051</p>	
<p>HARTING RJ Industrial® system cable, angled, 4-wire Type B, outdoor, angeld top to angled bottom</p> <p>Length 0.5 m 1.0 m 1.5 m 2.0 m 3.0 m 5.0 m</p>	<p>09 47 030 4067 09 47 030 4068 09 47 030 4069 09 47 030 4070 09 47 030 4071 09 47 030 4073</p>	

Other cable lengths on request

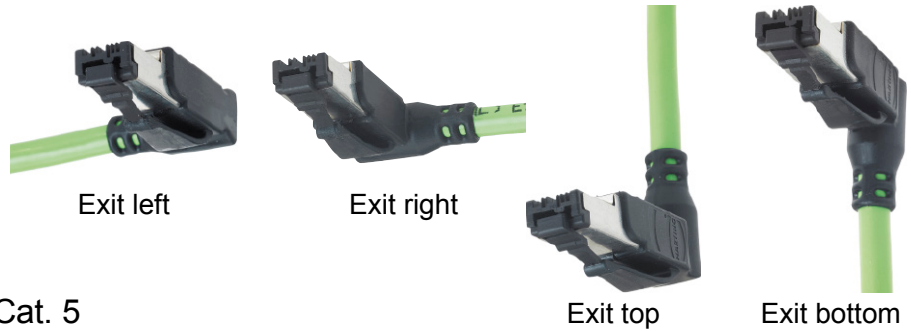

HARTING RJ Industrial®
system cable 4-wire, angled, Cat. 5

RJ45 cords

Features

- Connector types RJ45
- Category Cat. 5
- Number of wires 4
- Wiring 1:1
- Sheath material PVC/PUR

Application

- Industrial Cabling
- Within switch cabinets
- On machines and control units

Benefits

- Transmission of up to 100 Mbit/s
- Very robust RJ45 cord
- Very large temperature range
- Locking lever protection
- PROFINET compliant
- Useable as trailing cable (type C)

Technical characteristics

- Connector types RJ45 overmoulded and locking lever protection
- Cable type 4 x AWG 22/7, Cat. 5, Star quad, double shielding
- Sheath material
 - Type B PVC
 - Type C PUR
- Wiring 4 pole, contacts 1/2 and 3/6
- Transmission performance Category 5 class D up to 100 MHz acc. to ISO/IEC 11801, EN 50173-1
- Transmission rate 10/100 Mbit/s
- Shielding Fully shielded, 360° shielding contact
- Operating temperature range -40 °C ... +70 °C
- Colour
 - Green (PROFINET)
 - Black (PROFINET Outdoor)

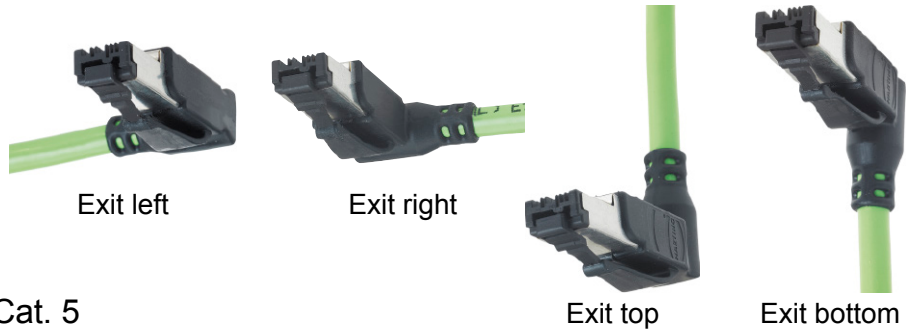

HARTING RJ Industrial®
system cable 4-wire, angled, Cat. 5

RJ45 cords

Identification	Part number				
	angled left	angled right	angled top	angled bottom	
HARTING RJ Industrial® system cable, angled, 4-wire Type B, one side pre-assembled, second side open	Length 0.5 m 1.0 m 1.5 m 2.0 m 3.0 m 5.0 m	09 47 050 0023 09 47 050 0024 09 47 050 0025 09 47 050 0026 09 47 050 0027 09 47 050 0029	09 47 060 0023 09 47 060 0024 09 47 060 0025 09 47 060 0026 09 47 060 0027 09 47 060 0029	09 47 030 0023 09 47 030 0024 09 47 030 0025 09 47 030 0026 09 47 030 0027 09 47 030 0029	09 47 040 0023 09 47 040 0024 09 47 040 0025 09 47 040 0026 09 47 040 0027 09 47 040 0029
HARTING RJ Industrial® system cable, angled, 4-wire Type C, one side pre-assembled, second side open	Length 0.5 m 1.0 m 1.5 m 2.0 m 3.0 m 5.0 m	09 47 050 0045 09 47 050 0046 09 47 050 0047 09 47 050 0048 09 47 050 0049 09 47 050 0051	09 47 060 0045 09 47 060 0046 09 47 060 0047 09 47 060 0048 09 47 060 0049 09 47 060 0051	09 47 030 0045 09 47 030 0046 09 47 030 0047 09 47 030 0048 09 47 030 0049 09 47 030 0051	09 47 040 0045 09 47 040 0046 09 47 040 0047 09 47 040 0048 09 47 040 0049 09 47 040 0051
HARTING RJ Industrial® system cable, angled, 4-wire Type B, one side pre-assembled, second side open	Length 0.5 m 1.0 m 1.5 m 2.0 m 3.0 m 5.0 m	09 47 050 0067 09 47 050 0068 09 47 050 0069 09 47 050 0070 09 47 050 0071 09 47 050 0073	09 47 060 0067 09 47 060 0068 09 47 060 0069 09 47 060 0070 09 47 060 0071 09 47 060 0073	09 47 030 0067 09 47 030 0068 09 47 030 0069 09 47 030 0070 09 47 030 0071 09 47 030 0073	09 47 040 0067 09 47 040 0068 09 47 040 0069 09 47 040 0070 09 47 040 0071 09 47 040 0073



preLink®
system cable, 4-wire, straight, Cat. 5

Features

- Connector types RJ45 – preLink®
- Category Cat. 5
- Number of wires 4
- Wiring 1:1
- Sheath material PUR

Application

- Industrial Cabling
- Within switch cabinets
- On machines and control units

Benefits

- Transmission of up to 100 Mbit/s
- Very robust RJ45 cord
- Very large temperature range
- PROFINET compliant
- Useable as trailing cable (type C)
- The preLink® termination block can be terminated to all preLink® components like the RJ45 or the M12 X- and D-coded plugs and jacks

Technical characteristics

- Connector types RJ45 overmoulded and locking lever protection
- Cable type 4 x AWG 22/7, Cat. 5, Star quad, double shielding
- Sheath material PUR
- Wiring 4 pole, contacts 1/2 and 3/6
- Transmission performance Category 5 class D up to 100 MHz acc. to ISO/IEC 11801, EN 50173-1
- Transmission rate 10/100 Mbit/s
- Shielding Fully shielded, 360° shielding contact
- Operating temperature range -40 °C ... +70 °C
- Colour Green (PROFINET)

Identification

Part number

preLink®
system cable, 4-wire, straight

Length	Part number
0.2 m	20 82 631 1002
0.4 m	20 82 631 1004
0.6 m	20 82 631 1006
0.8 m	20 82 631 1008
1.0 m	20 82 631 1010
2.0 m	20 82 631 1020
3.0 m	20 82 631 1030
4.0 m	20 82 631 1040
5.0 m	20 82 631 1050
10.0 m	20 82 631 1100



preLink®
system cable, 4-wire, straight, Cat. 5

Features

- Connector types preLink®
- Category Cat. 5
- Number of wires 4
- Wiring 1:1
- Sheath material PUR

Application

- Industrial Cabling
- Within switch cabinets
- On machines and control units

Benefits

- Transmission of up to 100 Mbit/s
- Very robust RJ45 cord
- Very large temperature range
- PROFINET compliant
- Useable as trailing cable (type C)
- The preLink® termination block can be terminated to all preLink® components like the RJ45 or the M12 X- and D-coded plugs and jacks

Technical characteristics

- Connector types RJ45 overmoulded and locking lever protection
- Cable type 4 x AWG 22/7, Cat. 5, Star quad, double shielding
- Sheath material PUR
- Wiring 4 pole, contacts 1/2 and 3/6
- Transmission performance Category 5 class D up to 100 MHz acc. to ISO/IEC 11 801, EN 50 173-1
- Transmission rate 10/100 Mbit/s
- Shielding Fully shielded, 360° shielding contact
- Operating temperature range -40 °C ... +70 °C
- Colour Green (PROFINET)

Identification

Part number

preLink®
system cable, 4-wire, straight

Length	Part number
0.2 m	20 82 630 2002
0.4 m	20 82 630 2004
0.6 m	20 82 630 2006
0.8 m	20 82 630 2008
1.0 m	20 82 630 2010
2.0 m	20 82 630 2020
3.0 m	20 82 630 2030
4.0 m	20 82 630 2040
5.0 m	20 82 630 2050
10.0 m	20 82 630 2100

Other cable lengths on request

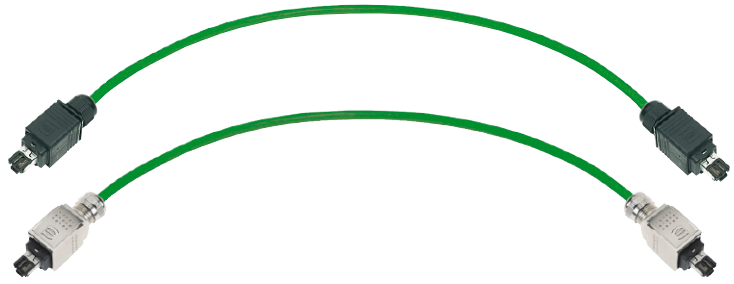

Han® PushPull RJ45 system cable, 4-wire, Cat. 5

RJ45 cords

Features

- Connector types Han® PushPull RJ45 (V14)
- Category Cat. 5
- Number of wires 4
- Wiring 1:1
- Sheath material PVC/PUR

Application

- Industrial Cabling
- Within switch cabinets
- On machines and control units

Benefits

- Standardised PushPull interface for IP65/IP67
- Very space-saving
- AIDA compliant
- PROFINET compliant
- Useable as trailing cable (type C)
- Easy and intuitive handling with HARTING PushPull technology

Technical characteristics

- Connector types Han® PushPull RJ45
- Cable type 4 x AWG 22/7, Cat. 5, Star quad, double shielding
- Sheath material
 - Type B PVC
 - Type C PUR
- Wiring 4 pole, contacts 1/2 and 3/6
- Transmission performance Category 5 class D up to 100 MHz acc. to ISO/IEC 11801, EN 50 173-1
- Transmission rate 10/100 Mbit/s
- Shielding Fully shielded, 360° shielding contact
- Operating temperature range
 - Type B -40 °C ... +70 °C
 - Type B outdoor -45 °C ... +60 °C
 - Type C -40 °C ... +70 °C
- Colour
 - Type B Green
 - Type B outdoor Black
 - Type C Green



Identification	Plastic version	Part number Metal version	Metal, overmoulded
Han® PushPull RJ45 system cable, 4-wire Type B			
Length 1.5 m	09 47 555 5033	09 47 565 6033	09 47 565 7033
3.0 m	09 47 555 5035	09 47 565 6035	09 47 565 7035
5.0 m	09 47 555 5037	09 47 565 6037	09 47 565 7037
10.0 m	09 47 555 5042	09 47 565 6042	09 47 565 7042
20.0 m	09 47 555 5044	09 47 565 6044	09 47 565 7044
Han® PushPull RJ45 system cable, 4-wire Type C			
Length 1.5 m	09 47 555 5063	09 47 565 6063	09 47 565 7063
3.0 m	09 47 555 5065	09 47 565 6065	09 47 565 7065
5.0 m	09 47 555 5067	09 47 565 6067	09 47 565 7067
10.0 m	09 47 555 5072	09 47 565 6072	09 47 565 7072
20.0 m	09 47 555 5074	09 47 565 6074	09 47 565 7074
Han® PushPull RJ45 system cable, 4-wire Type B, outdoor			
Length 1.5 m	09 47 555 5093	09 47 565 6093	09 47 565 7093
3.0 m	09 47 555 5095	09 47 565 6095	09 47 565 7095
5.0 m	09 47 555 5097	09 47 565 6097	09 47 565 7097
10.0 m	09 47 555 5102	09 47 565 6102	09 47 565 7102
20.0 m	09 47 555 5104	09 47 565 6104	09 47 565 7104

Other cable lengths on request



Han® 3 A RJ45 system cable, 4-wire, straight, Cat. 5

RJ45 cords

Features

- Connector types Han® 3 A RJ45 metal (V5)
- Category Cat. 5
- Number of wires 4
- Wiring 1:1
- Sheath material PVC/PUR

Application

- Industrial Cabling
- Within switch cabinets
- On machines and control units

Benefits

- Robust design
- Use on-site made possible by IP65/IP67 protection
- Easy handling for all applications
- PROFINET compliant
- Useable as trailing cable (type C)

Technical characteristics

- Connector types Han® 3 A RJ45 metal
- Cable type 4 x AWG 22/7, Cat. 5, Star quad, double shielding
- Sheath material
 - Type B PVC
 - Type C PUR
- Wiring 4 pole, contacts 1/2 and 3/6
- Transmission performance Category 5 class D up to 100 MHz acc. to ISO/IEC 11801, EN 50 173-1
- Transmission rate 10/100 Mbit/s
- Shielding Fully shielded, 360° shielding contact
- Operating temperature range
 - Type B -40 °C ... +70 °C
 - Type B outdoor -45 °C ... +60 °C
 - Type C -40 °C ... +70 °C
- Colour
 - Type B Green
 - Type B outdoor Black
 - Type C Green



Identification	Part number
<p>Han® 3 A RJ45 system cable, 4-wire Type B</p> <p>Length 1.5 m 3.0 m 5.0 m 10.0 m 20.0 m</p>	<p>09 45 715 1164 09 45 715 1166 09 45 715 1168 09 45 715 1173 09 45 715 1175</p>
<p>Han® 3 A RJ45 system cable, 4-wire Type C</p> <p>Length 1.5 m 3.0 m 5.0 m 10.0 m 20.0 m</p>	<p>09 45 715 0023 09 45 715 0025 09 45 715 0027 09 45 715 0051 09 45 715 0053</p>
<p>Han® 3 A RJ45 system cable, 4-wire Type B, outdoor</p> <p>Length 1.5 m 3.0 m 5.0 m 10.0 m 20.0 m</p>	<p>09 45 715 0064 09 45 715 0066 09 45 715 0068 09 45 715 0073 09 45 715 0075</p>

Other cable lengths on request



Han® 3 A RJ45 system cable, 4-wire, straight, Cat. 5

RJ45 cords

Features

- Connector types Han® 3 A RJ45 metal (V5) (IP65/IP67)/RJ45 (IP20)
- Category Cat. 5
- Number of wires 4
- Wiring 1:1
- Sheath material PVC/PUR

Application

- Industrial Cabling
- Within switch cabinets
- On machines and control units

Benefits

- Robust design
- Easy change-over from harsh industrial environment to protected IP20 environment
- Easy handling for all applications
- PROFINET compliant
- Useable as trailing cable (type C)

Technical characteristics

- Connector types Han® 3 A RJ45 metal (IP65/IP67)/RJ45 (IP20)
- Cable type 4 x AWG 22/7, Cat. 5, Star quad, double shielding
- Sheath material
 - Type B PVC
 - Type C PUR
- Wiring 4 pole, contacts 1/2 and 3/6
- Transmission performance Category 5 class D up to 100 MHz acc. to ISO/IEC 11801, EN 50 173-1
- Transmission rate 10/100 Mbit/s
- Shielding Fully shielded, 360° shielding contact
- Operating temperature range -40 °C ... +70 °C
- Colour Green



Identification	Part number	
<p>Han® 3 A RJ45 system cable, 4-wire Type B</p> <p>Length 1.5 m 3.0 m 5.0 m 10.0 m 20.0 m</p>	<p>09 45 700 1164 09 45 700 1166 09 45 700 1168 09 45 700 1173 09 45 700 1175</p>	
<p>Han® 3 A RJ45 system cable, 4-wire Type C</p> <p>Length 1.5 m 3.0 m 5.0 m 10.0 m 20.0 m</p>	<p>09 45 700 0023 09 45 700 0025 09 45 700 0027 09 45 700 0051 09 45 700 0053</p>	

Other cable lengths on request

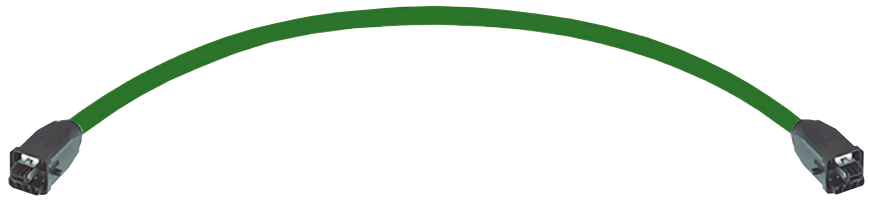

Han® 3 A RJ45 Hybrid system cable, 4-wire, straight, Cat. 5

RJ45 cords

Features

- Connector types Han® 3 A RJ45 Hybrid (V5) plastic/metal
- Category Cat. 5
- Number of wires 4 (data) + 4 (power)
- Wiring 1:1
- Sheath material FRNC, halogen free

Application

- Industrial Cabling
- Within switch cabinets
- On machines and control units

Benefits

- Robust design
- Use on-site made possible via IP65/IP67 protection
- Easy handling for applications with additional power supply
- PROFINET compliant

Technical characteristics

- Connector types Han® 3 A RJ45 Hybrid, plastic/metal
- Cable type 4 x AWG 22/7, star quad, shielded + 4 x 1.5 mm² power cores
- Sheath material FRNC, halogen free
- Wiring 4 pole, contacts 1/2 and 3/6
- Transmission performance Category 5 class D up to 100 MHz acc. to ISO/IEC 11801, EN 50173-1
- Transmission rate 10/100 Mbit/s
- Shielding Fully shielded, 360° shielding contact
- Operating temperature range -20 °C ... +70 °C
- Colour Green
- Data power supply:
 - Rated voltage 48 V/DC
 - Rated current 16 A



Identification	Part number
<p>Han® 3 A RJ45 Hybrid system cable, 4-wire, plastic</p> <p>Length 1.5 m 3.0 m 5.0 m 10.0 m 20.0 m</p>	<p>09 45 725 1323 09 45 725 1325 09 45 725 1327 09 45 725 1351 09 45 725 1353</p>
<p>Han® 3 A RJ45 Hybrid system cable, 4-wire, metal</p> <p>Length 1.5 m 3.0 m 5.0 m 10.0 m 20.0 m</p>	<p>09 45 715 1364 09 45 715 1366 09 45 715 1368 09 45 715 1373 09 45 715 1375</p>

Other cable lengths on request

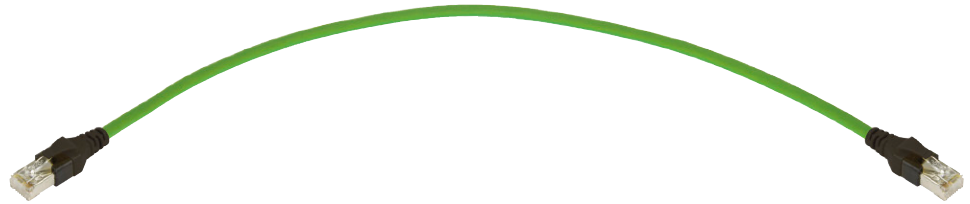

PROFINET cabinet cord Cat. 6_A

RJ45 cords

Features

- Connector types RJ45
- Category Cat. 6_A
- Number of wires 8
- Wiring 1:1
- Sheath material PVC

Application

- Industrial Cabling
- Within switch cabinets
- Within distribution cabinets on machines and control units

Benefits

- Transmission of up to 10 Gbit/s
- Very robust RJ45 cord
- Locking lever protection
- PROFINET compliant
- Reliable data transmission due to high EMC-immunity

Technical characteristics

- Connector types RJ45 overmoulded and locking lever protection
- Cable type S/FTP AWG 26/7, Cat. 6_A
- Sheath material PVC
- Wiring 8 pole, 1:1, TIA/EIA-568-B
- Transmission performance Category 6_A, Class E_A up to 500 MHz according ISO/IEC 11801 and EN 50 173-1
- Transmission rate 10/100 Mbit/s and 10 Gbit/s
- Shielding Fully shielded, 360° shielding contact
- Coupling attenuation ≥ 80 dB (segregation class d)
- Characteristic impedance 100 ± 5 Ω
- Lateral force 1000 N
- Bending radius Repeated bending ≥ 55 mm
Single bending ≥ 30 mm
- Operating temperature range -20 °C ... +70 °C
- Flame retardant acc. IEC 60332-1-2

Identification

Part number

Drawing

PROFINET cabinet cord
8-wire

Length	Part number
0.3 m	09 48 474 7766 003
0.5 m	09 48 474 7766 005
1.0 m	09 48 474 7766 010
1.5 m	09 48 474 7766 015
2.0 m	09 48 474 7766 020
3.0 m	09 48 474 7766 030
5.0 m	09 48 474 7766 050

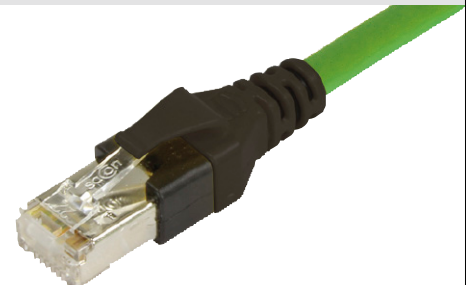

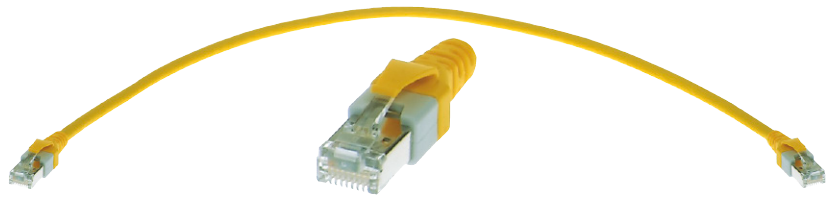

HARTING RJ Industrial®
patch cable, overmoulded, 8-wire, Cat. 5/Cat. 5e

Features

- Connector types RJ45
- Category Cat. 5/Cat. 5e
- Number of wires 8
- Wiring 1:1
- Sheath material PUR

Application

- Industrial Cabling
- Within switch cabinets
- On machines
- In IT networks

Benefits

- Robust industrial design
- Flexible, space saving
- Locking lever protection
- Halogen free and RoHS compliant
- Compliant acc. ISO/IEC 11801

Technical characteristics

- Connector types RJ45, overmoulded, with locking lever protection
- Cable types 4 x 2, Twisted Pair, shielded, SF/UTP
- Sheath material PUR, halogen free LSZH
- Wiring 8 pole, 1:1
- Transmission performance Category 5/Category 5e, Class D up to 100 MHz acc. to ISO/IEC 11801, EN 50 173-1
- Transmission rate 10/100/1000 Mbit/s
- Shielding Fully shielded, 360° shielding contact
- Operating temperature range
 - fixed operation -30 °C ... +75 °C
 - flexible operation -5 °C ... +50 °C
- Colour Yellow

Identification		Part number	Drawing	Dimensions in mm
HARTING RJ Industrial® patch cable, 8-wire, Cat. 5/Cat. 5e, overmoulded		Yellow		
Length	0.2 m	09 47 474 7001		
	0.3 m	09 47 474 7002		
	0.4 m	09 47 474 7003		
	0.5 m	09 47 474 7004		
	0.6 m	09 47 474 7005		
	0.7 m	09 47 474 7006		
	0.8 m	09 47 474 7007		
	0.9 m	09 47 474 7008		
	1.0 m	09 47 474 7009		
	1.5 m	09 47 474 7010		
	2.0 m	09 47 474 7011		
	2.5 m	09 47 474 7012		
	3.0 m	09 47 474 7013		
	4.0 m	09 47 474 7014		
	5.0 m	09 47 474 7015		
	6.0 m	09 47 474 7016		
	7.0 m	09 47 474 7017		
	7.5 m	09 47 474 7018		
	8.0 m	09 47 474 7019		
	9.0 m	09 47 474 7020		
	10.0 m	09 47 474 7021		
	15.0 m	09 47 474 7022		
	20.0 m	09 47 474 7023		
HARTING RJ Industrial® colour clips for HARTING RJ Industrial® connectors package with 10 pieces Colour:		Grey 09 45 870 0002 Yellow 09 45 870 0003 Orange 09 45 870 0006 Red 09 45 870 0007 Blue 09 45 870 0008 Green 09 45 870 0009 Black 09 45 870 0011		

Other cable lengths on request

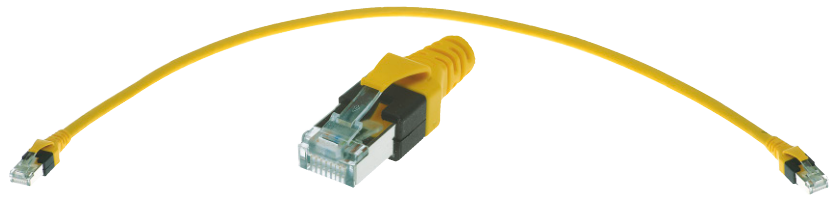

HARTING RJ Industrial®
patch cable, overmoulded, 8-wire, Cat. 6

Features

- Connector types RJ45
- Category Cat. 6
- Number of wires 8
- Wiring 1:1 and crossed
- Sheath material PUR

Application

- Industrial Cabling
- Within switch cabinets
- On machines
- In IT networks

Benefits

- Robust industrial design
- Flexible, space saving
- Locking lever protection
- Halogen free and RoHS compliant
- Compliant acc. ISO/IEC 11801

Technical characteristics

- Connector types RJ45, overmoulded, with locking lever protection
- Cable types 4 x 2, Twisted Pair, shielded, S/FTP
Category 7 acc. to IEC 61 156-6, EN 50288-4-2
- Sheath material PUR, halogen free LSZH
- Wiring 8 pole, 1:1 or crossed
- Transmission performance Category 6, Class E up to 250 MHz acc. to ISO/IEC 11801, EN 50173-1
- Transmission rate 10/100/1000 Mbit/s
- Shielding Fully shielded, 360° shielding contact
- Operating temperature range
fixed operation –30 °C ... +75 °C
flexible operation –5 °C ... +50 °C
- Colour Yellow

Identification		Part number		Drawing	Dimensions in mm
HARTING RJ Industrial® patch cable, 8-wire, Cat. 6, overmoulded		Yellow 1:1	Yellow crossed		
Length	0.2 m	09 47 474 7101	09 47 474 7141		
	0.3 m	09 47 474 7102	09 47 474 7142		
	0.4 m	09 47 474 7103	09 47 474 7143		
	0.5 m	09 47 474 7104	09 47 474 7144		
	0.6 m	09 47 474 7105	09 47 474 7145		
	0.7 m	09 47 474 7106	09 47 474 7146		
	0.8 m	09 47 474 7107	09 47 474 7147		
	0.9 m	09 47 474 7108	09 47 474 7148		
	1.0 m	09 47 474 7109	09 47 474 7149		
	1.5 m	09 47 474 7110	09 47 474 7150		
	2.0 m	09 47 474 7111	09 47 474 7151		
	2.5 m	09 47 474 7112	09 47 474 7152		
	3.0 m	09 47 474 7113	09 47 474 7153		
	4.0 m	09 47 474 7114	09 47 474 7154		
	5.0 m	09 47 474 7115	09 47 474 7155		
	6.0 m	09 47 474 7116	09 47 474 7156		
	7.0 m	09 47 474 7117	09 47 474 7157		
	7.5 m	09 47 474 7118	09 47 474 7158		
	8.0 m	09 47 474 7119	09 47 474 7159		
	9.0 m	09 47 474 7120	09 47 474 7160		
	10.0 m	09 47 474 7121	09 47 474 7161		
	15.0 m	09 47 474 7122	09 47 474 7162		
	20.0 m	09 47 474 7123	09 47 474 7163		
HARTING RJ Industrial® colour clips for HARTING RJ Industrial® connectors package with 10 pieces Colour:		Grey 09 45 870 0002 Yellow 09 45 870 0003 Orange 09 45 870 0006 Red 09 45 870 0007 Blue 09 45 870 0008 Green 09 45 870 0009 Black 09 45 870 0011			

Other cable lengths on request



Patch cable RJ45 DualBoot®,
Cat. 5/Cat. 5e, shielded

Features

- Connector types RJ45
- Category Cat. 5/Cat. 5e
- Number of wires 8
- Wiring 1:1
- Sheath material FRNC, halogen free

Application

- Industrial Cabling
- Within switch cabinets
- In IT networks

Benefits

- Flexible, space saving
- Different colours, characterization of services
- Halogen free and RoHS compliant
- Compliant acc. ISO/IEC 11801

Technical characteristics

- Connector types RJ45 with DualBoot®
- Cable type 4x2 Twisted Pair, screened SF-UTP
- Sheath material FRNC, halogen free
- Wiring 8 pole, 1:1
- Transmission performance Category 5/Category 5e, Class D up to 100 MHz according ISO/IEC 11801 and EN 50 173-1
- Transmission rate 10/100 Mbit/s and 1 Gbit/s
- Shielding Fully shielded, 360° shielding contact
- Operating temperature range 0 °C ... +60 °C
- Lengths All lengths available in 10 cm steps
- Lengths key xxx = length in dm (standard length: 5, 10, 15, 20, 25, 30, 50, 75 und 100 dm), e.g. 005 for 5 dm length
- Colour Grey, red, yellow, green, blue

Identification

Patch cable Cat. 5/Cat. 5e DualBoot® 1:1
 grey
 red
 yellow
 green
 blue

Part number

09 48 868 6569 xxx
 09 48 868 6570 xxx
 09 48 868 6571 xxx
 09 48 868 6572 xxx
 09 48 868 6573 xxx



Patch cable RJ45 DualBoot®,
Cat. 6A, shielded

Features

- Connector types RJ45
- Category Cat. 6A
- Number of wires 8
- Wiring 1:1
- Sheath material FRNC, halogen free

Application

- Industrial Cabling
- Within switch cabinets
- In IT networks

Benefits

- Transmission of up to 10 Gbit/s
- Flexible, space saving
- Different colours, characterization of services
- Halogen free and RoHS compliant
- Compliant acc. ISO/IEC 11801

Technical characteristics

- Connector types RJ45 with DualBoot®
- Cable type 4x2 Twisted Pair, screened SF-STP
- Sheath material FRNC, halogen free
- Wiring 8 pole, 1:1
- Transmission performance Category 6A, Class E_A up to 500 MHz according ISO/IEC 11801 and EN 50 173-1
- Transmission rate 10/100 Mbit/s and 1/10 Gbit/s
- Shielding Fully shielded, 360° shielding contact
- Operating temperature range 0 °C ... +60 °C
- Lengths All lengths available in 10 cm steps
- Lengths key xxx = length in dm (standard length: 5, 10, 15, 20, 25, 30, 50, 75 und 100 dm), e.g. 005 for 5 dm length
- Colour White, grey, red, yellow, green, blue, black

Identification

Patch cable Cat. 6A DualBoot® 1:1

- white
- grey
- red
- yellow
- green
- blue
- black

Part number

- 09 48 878 7584 xxx
- 09 48 878 7585 xxx
- 09 48 878 7586 xxx
- 09 48 878 7587 xxx
- 09 48 878 7588 xxx
- 09 48 878 7589 xxx
- 09 48 878 7590 xxx



PushPull patch cable RJ45 DualBoot®,
Cat. 5/Cat. 5e, shielded

Features

- Connector types RJ45 with PushPull locker
- Category Cat. 5/Cat. 5e
- Number of wires 8
- Wiring 1:1
- Sheath material FRNC, halogen free

Application

- Industrial Cabling
- Within switch cabinets
- In IT networks

Benefits

- PushPull locking mechanism
- Different colours, characterization of services
- Halogen free and RoHS compliant
- Compliant acc. ISO/IEC 11801

Technical characteristics

- Connector types RJ45 with DualBoot® and PushPull locker
- Cable type 4x2 Twisted Pair, screened SF-STP
- Sheath material FRNC, halogen free
- Wiring 8 pole, 1:1
- Transmission performance Category 5, Class D up to 100 MHz according ISO/IEC 11801 and EN 50 173-1
- Transmission rate 10/100 Mbit/s and 1/10 Gbit/s
- Shielding Fully shielded, 360° shielding contact
- Operating temperature range 0 °C ... +60 °C
- Lengths All lengths available in 10 cm steps
- Lengths key xxx = length in dm (standard length: 5, 10, 15, 20, 25, 30, 50, 75 und 100 dm), e.g. 005 for 5 dm length
- Colour Grey, red, yellow, green, blue, orange

Identification

PushPull patch cable Cat. 5/Cat. 5e DualBoot® 1:1
 grey
 red
 yellow
 green
 blue
 orange

Part number

09 48 898 9595 xxx
 09 48 898 9596 xxx
 09 48 898 9597 xxx
 09 48 898 9594 xxx
 09 48 898 9598 xxx
 09 48 898 9593 xxx

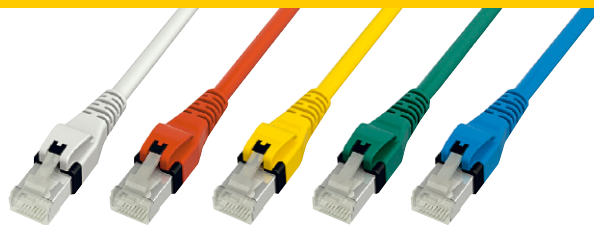

PushPull patch cable RJ45 DualBoot®
Cat. 6A, shielded

Features

- Connector types RJ45 with PushPull locker
- Category Cat. 6A
- Number of wires 8
- Wiring 1:1
- Sheath material FRNC, halogen free

Application

- Industrial Cabling
- Within switch cabinets
- In IT networks

Benefits

- Transmission of up to 10 Gbit/s
- PushPull locking mechanism
- Different colours, characterization of services
- Halogen free and RoHS compliant
- Compliant acc. ISO/IEC 11801

Technical characteristics

- Connector types RJ45 with DualBoot® and PushPull locker
- Cable type 4x2 Twisted Pair, screened SF-STP
- Sheath material FRNC, halogen free
- Wiring 8 pole, 1:1
- Transmission performance Category 6A, Class E_A up to 500 MHz according ISO/IEC 11801 and EN 50 173-1
- Transmission rate 10/100 Mbit/s and 1/10 Gbit/s
- Shielding Fully shielded, 360° shielding contact
- Operating temperature range 0 °C ... +60 °C
- Lengths All lengths available in 10 cm steps
- Lengths key xxx = length in dm (standard length: 5, 10, 15, 20, 25, 30, 50, 75 und 100 dm), e.g. 005 for 5 dm length
- Colour White, black, grey, red, yellow, green, blue, orange

Identification

PushPull patch cable Cat. 6A DualBoot® 1:1

- white
- black
- grey
- red
- yellow
- green
- blue
- orange

Part number

09 48 888 8574 xxx
 09 48 888 8575 xxx
 09 48 888 8576 xxx
 09 48 888 8577 xxx
 09 48 888 8578 xxx
 09 48 888 8579 xxx
 09 48 888 8580 xxx
 09 48 888 8592 xxx

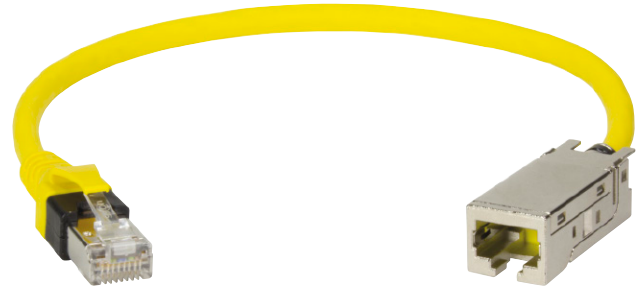

HARTING RJ Industrial® patch cable, overmoulded, 8-wire, Cat. 6A

Features

- Connector types RJ45
- Category Cat. 6A
- Number of wires 8
- Wiring 1:1
- Sheath material FRNC, halogen free

Application

- Industrial Cabling
- Within switch cabinets
- On machines
- In IT networks

Benefits

- Robust industrial design
- Flexible, space saving
- Locking lever protection
- Halogen free and RoHS compliant
- Compliant acc. ISO/IEC 11801

Technical characteristics

- Connector types RJ45, overmoulded, with locking lever protection
- Cable types 4 x 2, Twisted Pair, shielded, S/FTP
Category 7 acc. to IEC 61 156-6, EN 50288-4-2
- Sheath material FRNC, halogen free
- Wiring 8 pole, 1:1 or crossed
- Transmission performance Category 6A, Class EA up to 500 MHz acc. to ISO/IEC 11801, EN 50173-1
- Transmission rate 10/100/1000 Mbit/s
- Shielding Fully shielded, 360° shielding contact
- Operating temperature range 0 °C ... +60 °C
- Colour Yellow

Identification

HARTING RJ Industrial® patch cable, 8-wire

Length	Part number
0.15 m	09 45 545 1500
0.2 m	09 45 545 1501
0.3 m	09 45 545 1502
0.4 m	09 45 545 1503
0.5 m	09 45 545 1504
0.6 m	09 45 545 1505
0.7 m	09 45 545 1506
0.8 m	09 45 545 1507
0.9 m	09 45 545 1508
1.0 m	09 45 545 1509
1.5 m	09 45 545 1510
2.0 m	09 45 545 1511
2.5 m	09 45 545 1512
3.0 m	09 45 545 1513
3.5 m	09 45 545 1514
4.0 m	09 45 545 1515
5.0 m	09 45 545 1516
7.5 m	09 45 545 1517
10.0 m	09 45 545 1518

Part number

09 45 545 1500
09 45 545 1501
09 45 545 1502
09 45 545 1503
09 45 545 1504
09 45 545 1505
09 45 545 1506
09 45 545 1507
09 45 545 1508
09 45 545 1509
09 45 545 1510
09 45 545 1511
09 45 545 1512
09 45 545 1513
09 45 545 1514
09 45 545 1515
09 45 545 1516
09 45 545 1517
09 45 545 1518

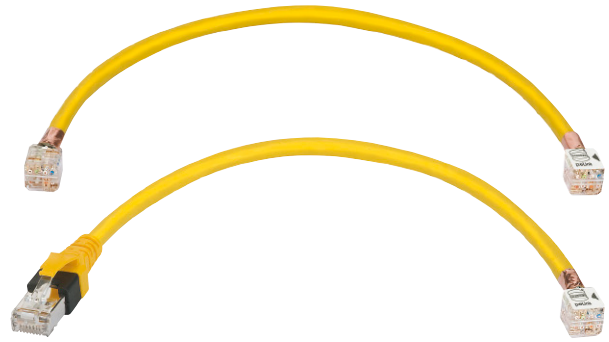

preLink®
patch cable, overmoulded, 8-wire, Cat. 6A

Features

- Connector types RJ45 – preLink®
- Category Cat. 6A
- Number of wires 8
- Wiring 1:1 and crossed
- Sheath material PUR

Application

- Industrial Cabling
- Within switch cabinets
- On machines
- In IT networks

Benefits

- Pre-assembled system cable
- Fast, flexible and reliable in the application
- Simple in handling
- Robust in design
- Installation of preLink® cables for industrial environment
- Connection cable for control or distributor cabinets or within controllers
- The preLink® termination block can be terminated to all preLink® components like the RJ45 or the M12 X- and D-coded plugs and jacks

Technical characteristics

- Cable types 4 x 2 AWG 27/7, shielded, S/FTP Cat. 7
- Sheath material PUR
- Wiring TIA/EIA 568B, 1:1
- Transmission performance Category 6A, Class E_A up to 500 MHz acc. to ISO/IEC 11801, EN 50 173-1
- Transmission rate 10/100 Mbit/s
1/10 Gbit/s
- Shielding Copper braid, tinned
- Operating temperature range
fixed operation –35 °C ... +70 °C
flexible operation –5 °C ... +50 °C
- Colour Yellow

preLink®
patch cable, overmoulded, 8-wire, Cat. 6A

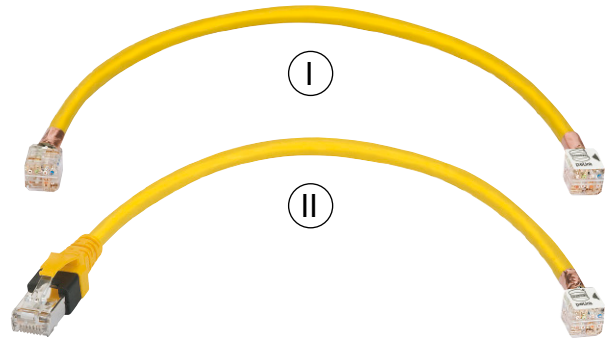

Identification	Part number	Drawing	Dimensions in mm
----------------	-------------	---------	------------------

preLink® patch cable

Yellow

terminal module to both sides, secured by protection cap	Length		Part number
0.4 m	20 82 600 2004		
0.6 m	20 82 600 2006		
0.8 m	20 82 600 2008		
1.0 m	20 82 600 2010		
2.0 m	20 82 600 2020		
3.0 m	20 82 600 2030		
4.0 m	20 82 600 2040		
5.0 m	20 82 600 2050		
10.0 m	20 82 600 2100		

I

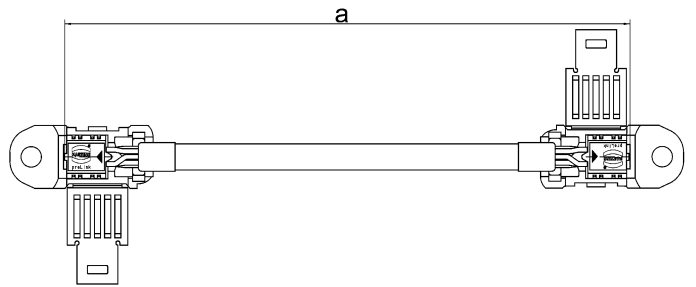

Side 1 with terminal module, secured by protection cap	Length		Part number
0.4 m	20 82 601 1004		
0.6 m	20 82 601 1006		
0.8 m	20 82 601 1008		
1.0 m	20 82 601 1010		
2.0 m	20 82 601 1020		
3.0 m	20 82 601 1030		
4.0 m	20 82 601 1040		
5.0 m	20 82 601 1050		
10.0 m	20 82 601 1100		

II

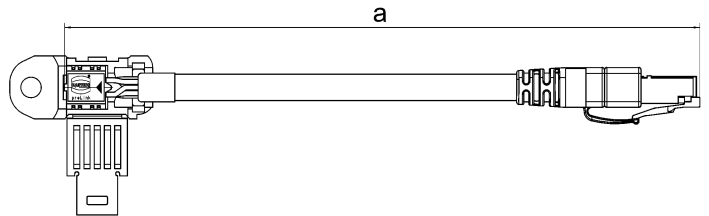



HARTING ix Industrial[®]
cable assemblies type A

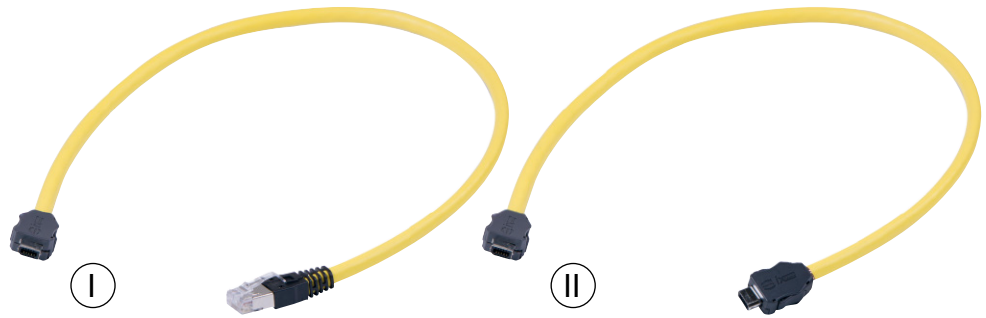

Features

- Connector types HARTING ix Industrial[®]
- Category Cat. 6A
- Number of wires 8
- Wiring 1:1
- Sheath material Pvc

Application

- Industrial Cabling
- Within switch cabinets
- On machines
- In IT networks

Benefits

- Miniaturised Ethernet data interface suitable for industry in acc. to IEC 61076-3-124 type A
- Robust industrial design
- 360° shielding
- Category of transmission Cat. 6A
- 5000 mating cycles
- Flexible, space saving
- Suitable for all PoE versions

Technical characteristics

Cable types	4 x 2 x AWG 28/7
Sheath material	PVC
Wiring	TIA/EIA 568B, 1:1
Transmission performance	Category 6A, Class E _A up to 500 MHz acc. to ISO/IEC 61076-3-124
Transmission rate	10/100 Mbit/s 1/2.5/5/10 Gbit/s
Shielding	Copper braid, tinned
Operating temperature range	-40 °C ... +80 °C
Colour	Yellow
RoHS	compliant

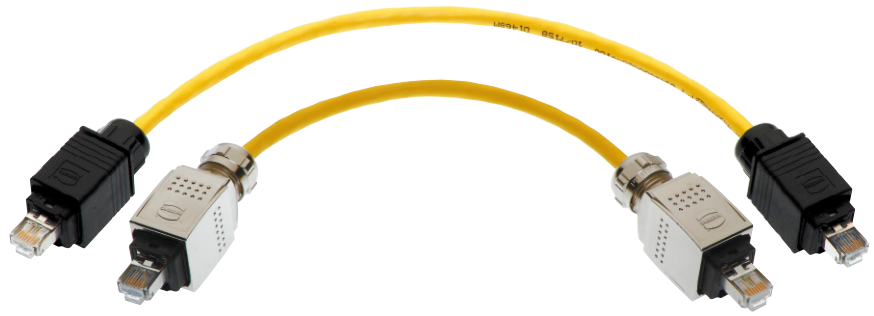

Han® PushPull RJ45 system cable, 8-wire, Cat. 6A

Features

- Connector types Han® PushPull RJ45 (V14)
- Category Cat. 6A
- Number of wires 8
- Wiring 1:1
- Sheath material PUR

Application

- Industrial Cabling
- Within switch cabinets
- On machines and control units

Benefits

- Standardised PushPull interface for IP65/IP67
- Especially space-saving
- AIDA compliant
- Easy and intuitive handling with HARTING PushPull technology

Technical characteristics

- Connector types Han® PushPull RJ45
- Cable type 4 x 2, Twisted Pair, shielded
- Sheath material PUR
- Wiring 8 pole, 1:1
- Transmission performance Category 6A, Class E_A up to 500 MHz acc. to ISO/IEC 11801, EN 50 173-1
- Transmission rate 10/100 Mbit/s
1/ 10 Gbit/s
- Shielding Fully shielded, 360° shielding contact
- Operating temperature range -10 °C ... +70 °C
- Colour Green/Yellow

Identification	Part number		Metal
	Plastic	Metal	
Han® PushPull RJ45 system cable, 8-wire	Yellow	Yellow	PROFINET Green
Length 1.5 m	09 47 575 7001	09 47 585 8001	09 48 171 7165 015
3.0 m	09 47 575 7002	09 47 585 8002	09 48 171 7165 030
5.0 m	09 47 575 7003	09 47 585 8003	09 48 171 7165 050
10.0 m	09 47 575 7004	09 47 585 8004	09 48 171 7165 100
20.0 m	09 47 575 7005	09 47 585 8005	09 48 171 7165 200

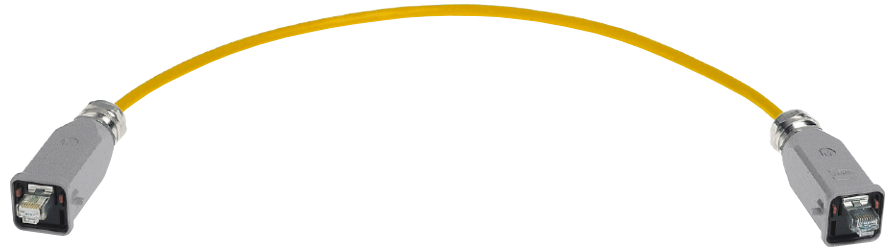

Han® 3 A RJ45 system cable, 8-wire, Cat. 6A

Features

- Connector types Han® 3 A RJ45 (V5)
- Category Cat. 6A
- Number of wires 8
- Wiring 1:1
- Sheath material PVC/PUR

Application

- Industrial Cabling
- Between I/O and controllers
- On machines and control units

Benefits

- Transmission of up to 10 Gbit/s
- Very robust RJ45 cord
- Complete IP65/IP67 rated
- ISO/IEC 11801 compliant

Technical characteristics

- Connector types Han® 3 A RJ45
- Cable types 4 x 2, Twisted Pair, shielded
- Sheath material PVC/PUR
- Wiring 8 pole, 1:1
- Transmission performance Category 6A, Class E_A up to 500 MHz acc. to ISO/IEC 11801, EN 50 173-1
- Transmission rate 10/100 Mbit/s
1/ 10 Gbit/s
- Shielding Fully shielded, 360° shielding contact
- Operating temperature range -10 °C ... +70 °C
- Colour Yellow

Identification	Part number		Drawing	Dimensions in mm
	PVC	PUR		
Han® 3 A RJ45 system cable, 8-wire	Yellow	Yellow		
Length 1.5 m	09 45 715 1523	09 45 715 1563		
3.0 m	09 45 715 1525	09 45 715 1565		
5.0 m	09 45 715 1527	09 45 715 1567		
10.0 m	09 45 715 1551	09 45 715 1572		
20.0 m	09 45 715 1553	09 45 715 1574		

Other cable lengths on request

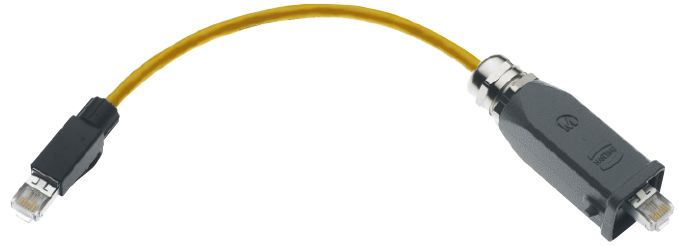

Han® 3 A RJ45 system cable, 8-wire, Cat. 6_A

Features

- Connector types Han® 3 A RJ45 (V5)/RJ45 IP20
- Category Cat. 6_A
- Number of wires 8
- Wiring 1:1
- Sheath material PVC/PUR

Application

- Industrial Cabling
- Connection between generic cabling and machine cabling
- On machines and control units

Benefits

- Transmission of up to 10 Gbit/s
- Very robust RJ45 cord
- Single sided IP65/IP67 rated
- ISO/IEC 11801 compliant
- PROFINET compliant

Technical characteristics

- Connector types Han® 3 A RJ45 (IP65/IP67) RJ45 (IP20)
- Cable types 4 x 2, Twisted Pair, shielded
- Sheath material PVC/PUR
- Wiring 8 pole, 1:1
- Transmission performance Category 6_A, Class E_A up to 500 MHz acc. to ISO/IEC 11801, EN 50173-1
- Transmission rate 10/100 Mbit/s
1/10 Gbit/s
- Shielding Fully shielded, 360° shielding contact
- Operating temperature range -10 °C to +70 °C
- Colour Yellow

Identification	Part number		Drawing	Dimensions in mm
	PVC	PUR		
Han® 3 A RJ45 system cable, 8-wire IP65/IP67 to IP20	Yellow	Yellow		
Length 1.5 m	09 45 701 1564	09 45 701 1534		
3.0 m	09 45 701 1566	09 45 701 1536		
5.0 m	09 45 701 1568	09 45 701 1538		
10.0 m	09 45 701 1573	09 45 701 1543		
20.0 m	09 45 701 1575	09 45 701 1545		

Other cable lengths on request



Han® 3 A RJ45 Hybrid system cable, 8-wire, Outdoor, plastic, Cat. 6A

Features

• Connector types	Han® 3 A RJ45 (V5) Hybrid, plastic
• Category	Cat. 6A
• Number of wires	8 (data) + 4 (power)
• Wiring	1:1
• Sheath material	PUR

Application

- Industrial Cabling
- Connection between generic cabling and machine cabling
- On machines and control units

Benefits

- Transmission of up to 10 Gbit/s
- Use on-site made possible via IP65/IP67 protection
- Easy handling for applications with additional power supply
- PROFINET compliant

Technical characteristics

Connector types	Han® 3 A RJ45 Hybrid, plastic
Cable types	4 x 2, Twisted Pair, shielded + 4 x 1.5 power cores
Sheath material	PUR
Wiring	8 pole, 1:1
Transmission performance	Category 6A, Class E up to 500 MHz according to ISO/IEC 11801, EN 50173-1
Transmission rate	10/100 Mbit/s 1/ 10 Gbit/s
Shielding	Fully shielded, 360° shielding contact
Operating temperature range	-10 °C ... +70 °C
Colour	Black
Data power supply	
Rated voltage	48 V/DC
Rated current	16 A

Identification	Part number PUR	Drawing	Dimensions in mm
Han® 3 A RJ45 Hybrid system cable, 8-wire	Black		
Length			
1.5 m	09 45 725 1503		
3.0 m	09 45 725 1505		
5.0 m	09 45 725 1507		
10.0 m	09 45 725 1512		
20.0 m	09 45 725 1514		

Other cable lengths on request



Han® 3 A RJ45 Hybrid system cable, 8-wire, Outdoor, metal, Cat. 6_A

Features

- Connector types Han® 3 A RJ45 (V5) Hybrid, metal
- Category Cat. 6_A
- Number of wires 8 (data) + 4 (power)
- Wiring 1:1
- Sheath material PUR

Application

- Industrial Cabling
- Connection between generic cabling and machine cabling
- On machines and control units

Benefits

- Transmission of up to 10 Gbit/s
- Use on-site made possible via IP65/IP67 protection
- Easy handling for applications with additional power supply
- PROFINET compliant

Technical characteristics

- Connector types Han® 3 A RJ45 Hybrid, metal
- Cable types 4 x 2, Twisted Pair, shielded + 4 x 1.5 mm² power cores
- Sheath material PUR
- Wiring 8 pole, 1:1
- Transmission performance Category 6_A, Class E up to 500 MHz according to ISO/IEC 11801, EN 50173-1
- Transmission rate 10/100 Mbit/s
1/ 10 Gbit/s
- Shielding Fully shielded, 360° shielding contact
- Operating temperature range -10 °C ... +70 °C
- Colour Black
- Data power supply
Rated voltage 48 V/DC
Rated current 16 A

Identification	Part number PUR	Drawing	Dimensions in mm
Han® 3 A RJ45 Hybrid system cable, 8-wire Outdoor	Black		
Length			
1.5 m	09 45 725 1533		
3.0 m	09 45 725 1535		
5.0 m	09 45 725 1537		
10.0 m	09 45 725 1542		
20.0 m	09 45 725 1544		



HARTING PushPull RJ45 system cable, 8-wire, straight, Cat. 6A

Features

- Connector types HARTING PushPull RJ45 (V4)
- Category Cat. 6A
- Number of wires 8
- Wiring 1:1

Application

- Industrial Cabling
- Outdoor
- On machines and control units

Benefits

- Transmission of up to 10 Gbit/s
- Double-sided IP65/IP67 protection
- Easy and intuitive handling with HARTING PushPull technology

Technical characteristics

- Connector types HARTING PushPull RJ45
- Cable type 4 x 2 x AWG 26/7, Cat. 6A
- Wiring 8 pole, 1:1
- Transmission performance Category 6A, Class E up to 500 MHz according to ISO/IEC 11 801, EN 50 173-1
- Transmission rate 10/100 Mbit/s
1/ 10 Gbit/s
- Shielding Fully shielded, 360° shielding contact
- Operating temperature range
 - PUR -40 °C ... +80 °C
 - PVC -20 °C ... +80 °C
 - Outdoor -20 °C ... +80 °C
- Colour Yellow, black

Identification	Part number		
	PUR	PVC	Outdoor
HARTING PushPull RJ45 system cable, 8-wire	Yellow	Yellow	Black
Length 0.5 m	09 48 282 8756 005	09 48 282 8757 005	09 48 282 8758 005
1.0 m	09 48 282 8756 010	09 48 282 8757 010	09 48 282 8758 010
5.0 m	09 48 282 8756 050	09 48 282 8757 050	09 48 282 8758 050
7.5 m	09 48 282 8756 075	09 48 282 8757 075	09 48 282 8758 075
10.0 m	09 48 282 8756 100	09 48 282 8757 100	09 48 282 8758 100
15.0 m	09 48 282 8756 150	09 48 282 8757 150	09 48 282 8758 150
20.0 m	09 48 282 8756 200	09 48 282 8757 200	09 48 282 8758 200

Other cable lengths on request



HARTING PushPull RJ45
system cable, 8-wire, straight, Cat. 6A

Features

- Connector types HARTING PushPull (V4) RJ45/RJ45 IP20
- Category Cat. 6A
- Number of wires 8
- Wiring 1:1

Application

- Industrial Cabling
- Within switch cabinets
- On machines and control units

Benefits

- Transmission of up to 10 Gbit/s
- Easy interface between hard industrial areas to the protected IP20 environment
- Easy and intuitive handling with HARTING PushPull technology

Technical characteristics

- Connector types HARTING PushPull RJ45 (IP65/IP67) RJ45 (IP20)
- Cable type S/FTP AWG 22/7, Cat. 6A
- Wiring 8 pole, 1:1
- Transmission performance Category 6A, Class E up to 500 MHz according to ISO/IEC 11 801, EN 50 173-1
- Transmission rate 10/100 Mbit/s
1/ 10 Gbit/s
- Shielding Fully shielded, 360° shielding contact
- Operating temperature range -20 °C ... +75 °C
- Colour Yellow, black

Identification	PUR	Part number PVC	Outdoor
HARTING PushPull RJ45 system cable, 8-wire IP65/IP67 on IP20	Yellow	Yellow	Black
Length 1.0 m	09 48 284 7756 010	09 48 284 7757 010	09 48 284 7758 010
2.0 m	09 48 284 7756 020	09 48 284 7757 020	09 48 284 7758 020
3.0 m	09 48 284 7756 030	09 48 284 7757 030	09 48 284 7758 030
5.0 m	09 48 284 7756 050	09 48 284 7757 050	09 48 284 7758 050
7.0 m	09 48 284 7756 070	09 48 284 7757 070	09 48 284 7758 070
10.0 m	09 48 284 7756 100	09 48 284 7757 100	09 48 284 7758 100
15.0 m	09 48 284 7756 150	09 48 284 7757 150	09 48 284 7758 150
20.0 m	09 48 284 7756 200	09 48 284 7757 200	09 48 284 7758 200

Other cable lengths on request



HARTING PushPull RJ45 system cable, 8-wire, straight, Cat. 6A

Features

- Connector types HARTING PushPull RJ45 (V4)
- Category Cat. 6A
- Number of wires 8
- Wiring 1:1
- Sheath material PUR

Application

- Industrial Cabling
- On machines and control units

Benefits

- Transmission of up to 100 Mbit/s
- Double-sided IP65/IP67 protection
- Very large temperature range
- Easy and intuitive handling with HARTING PushPull technology

Technical characteristics

- Connector types HARTING PushPull RJ45 female and male
- Cable type S/FTP AWG 26/7, Cat. 6A
- Sheath material PUR
- Wiring 8 pole, 1:1
- Transmission performance Category 6A, Class E up to 500 MHz according to ISO/IEC 11801, EN 50173-1
- Transmission rate 10/100 Mbit/s
1/10 Gbit/s
- Shielding Fully shielded, 360° shielding contact
- Operating temperature range -35 °C ... +70 °C
- Colour Yellow

Identification	Part number PUR	Drawing	Dimensions in mm
HARTING PushPull RJ45 system cable, 8-wire	Yellow		
Length			
0.5 m	33 45 232 0050 003		
1.0 m	33 45 232 0100 003		
2.0 m	33 45 232 0200 003		
3.0 m	33 45 232 0300 003		
5.0 m	33 45 232 0500 003		
7.5 m	33 45 232 0750 003		
10.0 m	33 45 232 1000 003		

Other cable lengths on request



HARTING M12 system cable, 4-wire, straight resp. angled, Cat. 5

M12 cords

Features

- Connector types M12 D-coding connector and female, straight and angled
- Category Cat. 5
- Number of wires 4
- Wiring 1:1
- Sheath material PVC/PUR

Application

- For harsh industrial environments
- On machines and control units
- PROFINET transmission

Benefits

- Robust design
- Use on-site made possible by IP65/IP67 protection
- PUR variants are useable as trailing cables and oil proof

Technical characteristics

- Connector types HARTING M12 D-coding, overmoulded
- Cable types 4 x AWG 22/7, Cat. 5, Star quad, double shielding
- Sheath material PVC/PUR
- Wiring 4 pole, 1:1
- Transmission performance Class D up to 100 MHz acc. to ISO/IEC 11801, EN 50 173-1
- Transmission rate 10/100 Mbit/s
- Shielding Fully shielded, 360° shielding contact
- Operating temperature range -25 °C ... +70 °C
- Colour Green



HARTING M12
system cable, 4-wire,
straight resp. angled, Cat. 5

Identification			Part number	
			PUR	PVC
both sides assembled connector straight to connector straight	Length	0.5 m	21 34 929 2477 005	21 34 929 2405 005
		1.0 m	21 34 929 2477 010	21 34 929 2405 010
		1.5 m	21 34 929 2477 015	21 34 929 2405 015
		2.0 m	21 34 929 2477 020	21 34 929 2405 020
		5.0 m	21 34 929 2477 050	21 34 929 2405 050
		7.5 m	21 34 929 2477 075	21 34 929 2405 075
		10.0 m	21 34 929 2477 100	21 34 929 2405 100
		both sides assembled connector straight to female angled	Length	0.5 m
1.0 m	21 34 929 3477 010			21 34 929 3405 010
1.5 m	21 34 929 3477 015			21 34 929 3405 015
2.0 m	21 34 929 3477 020			21 34 929 3405 020
5.0 m	21 34 929 3477 050			21 34 929 3405 050
7.5 m	21 34 929 3477 075			21 34 929 3405 075
10.0 m	21 34 929 3477 100			21 34 929 3405 100
one side assembled connector straight to open end	Length			0.5 m
		1.0 m	21 34 920 0477 010	21 34 920 0405 010
		1.5 m	21 34 920 0477 015	21 34 920 0405 015
		2.0 m	21 34 920 0477 020	21 34 920 0405 020
		5.0 m	21 34 920 0477 050	21 34 920 0405 050
		7.5 m	21 34 920 0477 075	21 34 920 0405 075
		10.0 m	21 34 920 0477 100	21 34 920 0405 100
		one side assembled female straight to open end	Length	0.5 m
1.0 m	21 34 930 0477 010			21 34 930 0405 010
1.5 m	21 34 930 0477 015			21 34 930 0405 015
2.0 m	21 34 930 0477 020			21 34 930 0405 020
5.0 m	21 34 930 0477 050			21 34 930 0405 050
7.5 m	21 34 930 0477 075			21 34 930 0405 075
10.0 m	21 34 930 0477 100			21 34 930 0405 100
both sides assembled connector angled to connector angled	Length			0.5 m
		1.0 m	21 34 949 4477 010	21 34 949 4405 010
		1.5 m	21 34 949 4477 015	21 34 949 4405 015
		2.0 m	21 34 949 4477 020	21 34 949 4405 020
		5.0 m	21 34 949 4477 050	21 34 949 4405 050
		7.5 m	21 34 949 4477 075	21 34 949 4405 075
		10.0 m	21 34 949 4477 100	21 34 949 4405 100

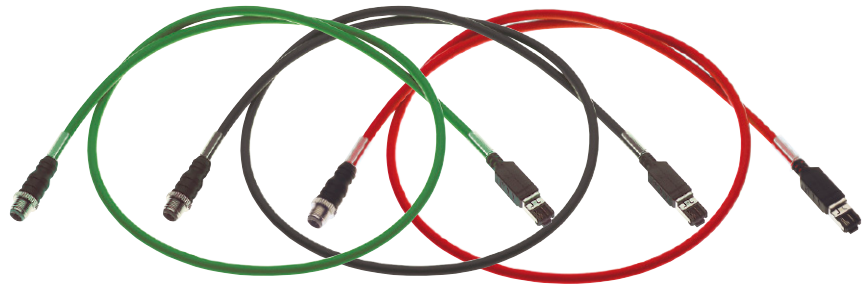

HARTING M12/RJ45 system cable, 4-wire, Cat. 5

M12 cords

Features

- Connector types M12 D-coding - RJ45
- Category Cat. 5
- Number of wires 4
- Wiring See technical characteristics
- Sheath material PVC/PUR

Application

- Industrial cabling
- On machines and control units
- PROFINET transmission

Benefits

- Robust design
- Useable as trailing cable (type C)
- Overmoulded connectors

Technical characteristics

- Connector types HARTING M12 D-coding, overmoulded (IP65/IP67)
RJ45 4 pole, contacts 1/2 and 3/6, overmoulded (IP20)
- Cable types 4 x AWG 22/7, Cat. 5, Star quad, double shielding
- Sheath material PVC/PUR
- Wiring 4 pole
- Transmission performance Cat. 5e, Class D up to 100 MHz acc. to ISO/IEC 11801, EN 50 173-1
- Transmission rate 10/100 Mbit/s
- Shielding Fully shielded, 360° shielding contact
- Operating temperature range -30 °C ... +70 °C
- Colour Green/Black
Red (SERCOS III)
- Contact assignment

Signal	M12 D-coding	RJ45
TD+	1	1
TD-	3	2
RD+	2	3
RD-	4	6

Identification	Part number		
	PUR	PVC	SERCOS III PUR
HARTING M12/RJ45 system cable, 4-wire	Green	Black	Red
Length			
1.0 m	09 45 700 5022	09 45 700 5063	09 47 220 2003 018
3.0 m	09 45 700 5025	09 45 700 5066	09 47 220 2005 018
5.0 m	09 45 700 5027	09 45 700 5068	09 47 220 2007 018
10.0 m	09 45 700 5051	09 45 700 5073	09 47 220 2012 018
20.0 m	09 45 700 5053	09 45 700 5075	09 47 220 2014 018

Other cable lengths on request



Press & Go M12
system cable, 8-wire, Cat. 6_A

Features

- Connector types M12 X-coding
- Category Cat. 6_A
- Number of wires 8
- Wiring 1:1
- Sheath material PVC/PUR

Application

- Industrial cabling IP65/IP67
- Transmission up to 10 Gbit/s
- Camera systems

Benefits

- Very robust metal housing M12 with degree of protection IP65/IP67
- Vibration proof crimp connection
- Maximum data rates through the configuration of the contacts in conformance with Ethernet technology
- Minimal interaction and perfect shielding through paired shielding of the contacts
- Fault proof connection through coding of the connector face. A connection error with other 8 pole M12's is impossible
- PROFINET compliant Type X mating face
- Oil proof acc. to EN 60811-2-1 (PUR)

Technical characteristics

- Connector types Press & Go M12 connector
X coding acc. to IEC 61076-2-109
- Cable types PVC: 4 x 2 x AWG 26/7, cat. 6_A,
S/FTP, shielded
PUR: 4 x 2 x AWG 26/7, cat. 7,
S/FTP, shielded
- Sheath material PVC/PUR
- Wiring 8 pole, 1:1
- Transmission performance Category 6_A,
Class E_A up to 500 MHz
acc. to ISO/IEC 11801,
EN 50173-1
- Transmission rate 10/100 Mbit/s
1/ 10 Gbit/s
- Shielding Fully shielded,
360° shielding contact
- Operating temperature range -40 °C ... +70 °C
- Colour Yellow



Press & Go M12
system cable, 8-wire, Cat. 6A

M12 cords

Identification	Part number	
	PUR	PVC
Press & Go M12 system cable, 8-wire one side assembled		
Length 1.0 m	21 33 050 0850 010	21 33 050 0855 010
2.0 m	21 33 050 0850 020	21 33 050 0855 020
3.0 m	21 33 050 0850 030	21 33 050 0855 030
5.0 m	21 33 050 0850 050	21 33 050 0855 050
10.0 m	21 33 050 0850 100	21 33 050 0855 100
both sides assembled		
Length 1.0 m	21 33 050 5850 010	21 33 050 5855 010
2.0 m	21 33 050 5850 020	21 33 050 5855 020
3.0 m	21 33 050 5850 030	21 33 050 5855 030
5.0 m	21 33 050 5850 050	21 33 050 5855 050
10.0 m	21 33 050 5850 100	21 33 050 5855 100

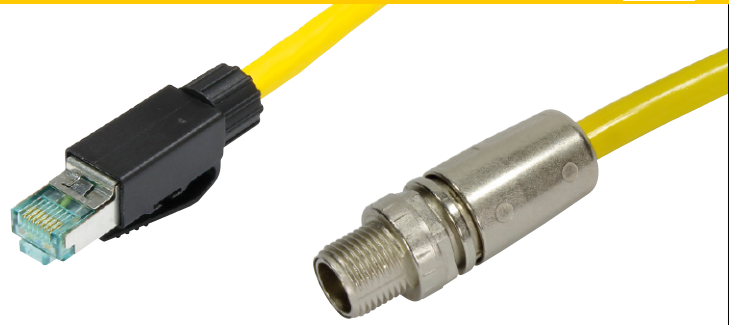

M12/RJ45
system cable, 8-wire, Cat. 6_A

Features

- Connector types M12 X-coding to RJ45
- Category Cat. 6_A
- Number of wires 8
- Wiring 1:1
- Sheath material PVC/PUR

Application

- Industrial cabling IP65/IP67
- Transmission up to 10 Gbit/s
- Camera systems

Benefits

- Very robust metal housing M12 with degree of protection IP65
- Vibration proof crimp connection
- Maximum data rates through the configuration of the contacts in conformance with Ethernet technology
- Minimal interaction and perfect shielding through paired shielding of the contacts
- Fault proof connection through coding of the connector face. A connection error with other 8 pole M12's is impossible
- PROFINET compliant Type X mating face

Technical characteristics

- Connector types *har*-speed M12 connector X coding acc. to IEC 61076-2-109 and RJ45 Gigalink
- Cable types 4 x 2 x AWG 26/7, cat. 6_A, S/FTP, shielded
- Sheath material PVC/PUR
- Wiring 8 pole, 1:1
- Transmission performance Category 6_A, Class E_A up to 500 MHz acc. to ISO/IEC 11801, EN 50173-1
- Transmission rate 10/100 Mbit/s
1/ 10 Gbit/s
- Shielding Fully shielded, 360° shielding contact
- Operating temperature range -40 °C ... +70 °C
- Colour Yellow

Identification	Part number	
	PUR	PVC
M12/RJ45 system cable, 8-wire	Yellow	Yellow
Length		
0.5 m	09 48 932 3756 005	09 48 932 3757 005
1.0 m	09 48 932 3756 010	09 48 932 3757 010
1.5 m	09 48 932 3756 015	09 48 932 3757 015
2.0 m	09 48 932 3756 020	09 48 932 3757 020
2.5 m	09 48 932 3756 025	09 48 932 3757 025
5.0 m	09 48 932 3756 050	09 48 932 3757 050
7.5 m	09 48 932 3756 075	09 48 932 3757 075
10.0 m	09 48 932 3756 100	09 48 932 3757 100

Other cable lengths on request

X-coding



Female, 8 poles



har-speed M12
Panel feed-throughs with cable

M12 cords

Identification	Part number	Drawing	Dimensions in mm
----------------	-------------	---------	------------------

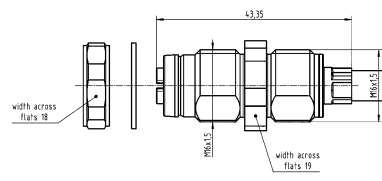
 <p><i>har-speed</i> M12 PFT with cable</p> <p>with 0.3 m cable "Cat. 7_A (2 x AWG 27/7) PIMF". Other lengths on request</p> <p>with 0.3 m cable "HA-VIS EtherRail Cat. 7 4 x (2 x AWG 24/7)". Other lengths on request</p>	<p>21 33 080 0850 003</p> <p>21 33 070 0853 003</p>		
---	---	--	--

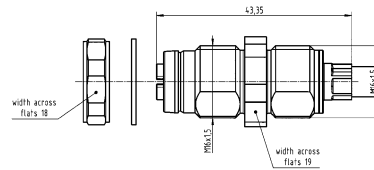

Directory Chapter 02

Page

General information	02.03
4-wire	
Industrial Cat. 5 standard cable, type A	02.08
Industrial Cat. 5 stranded cable, type B	02.09
Industrial Cat. 5 stranded cable, type B, outdoor	02.10
Industrial Cat. 5 stranded cable, type C, trailing	02.11
Industrial Cat. 5 stranded cable, type C, torsion	02.12
8-wire	
PROFINET 4 TP type A cable	02.13
PROFINET 4 TP type B cable	02.14
Industrial Cat. 5 high flexible cable	02.15
Industrial Cat. 5 stranded cable, outdoor	02.16
Industrial Cat. 6 _A stranded cable	02.17
Industrial Cat. 6 _A stranded cable, outdoor	02.19
Industrial Cat. 7 sea cable	02.20
Industrial Cat. 7 _A cable	02.21



All relevant copper cables that, in conjunction with HARTING's connectors (refer to chapter 03), support Fast Ethernet, Gigabit Ethernet and 10 Gigabit Ethernet are listed in the HARTING data cables chapter.

Specifically, these are:

- Four-wire data cables for Fast Ethernet (Category 5 for 100 Mbit/s) in accordance with PROFINET specification to IEC 61784-5-3 and IEC 61918

PROFINET hybrid cables are assigned to the hybrid connectors in chapter 03

- Eight-wire data cables for Gigabit Ethernet (Category 5e or 6 for 1 Gbit/s and Category 6_A or 7 for 10 Gbit/s) according to ISO/IEC 11801 and EN 50173

Hybrid cables are assigned to the hybrid connectors in chapter 03

HARTING data cables are specially designed to meet the requirements of industrial environments and work optimally when assembled together with HARTING connectors.

This combination ensures easy, quick and safe on-site installations.

All HARTING data cables are excellent for providing reliable Ethernet transmissions in extreme environmental conditions.

They are fully shielded and designed to transmit data in compliance with Category 5/5e (up to 100 MHz), or up to Category 7_A (up to 1000 MHz).

The HARTING data cables are labelled with HARTING specific printing that includes the existing file listings (special testing proofs) and the HARTING raw cable number.

The HARTING raw cable number is always the same for one cable type, even when the cable is sold in different packaging (lengths) or pre-assembled.

Thus, there is always a difference between the printed raw cable number and the HARTING article number on the label!

In any cabling facility, the cables play a crucial role. For the industrial or semi-industrial Ethernet-based applications considered in this catalogue, it is primarily symmetrical copper data lines (twisted pair and quads), hybrid cables (combined data and power supply lines up to 48 V) and fibre optic cables (fibre optic and POF) which are used.

Additional construction types (e.g. USB for service interfaces or MVB/WTB bus cables) are listed to complete the Ethernet cabling portfolios.

The customer's decision on which cables to use is based on the particular application (what is being transferred), the installation environment (where the cabling is being installed), the available connector systems (what terminating technology or connectors are being used with the cable) and any additional properties and tests required (long-term stability, fire testing, etc.).

These requirements result in the specifications for the cable, which must always correlate with the cable's termination technique (IDC, preLink®, crimp, piercing or terminal for copper) and its connector (SC, LC, etc. for fibre optic; M12, RJ45 or Han® for copper). The specification for the data cable, created in this way, then determines which cable should be used. Each customer can create this cable specification by answering the following questions related to the customer's own application:

1. Will you be using copper, hybrid or fibre optic cables?

- The range of copper data and hybrid cables is generally limited to 100 metres. When using smaller wire cross-sections (e.g. AWG 26), the length decreases to approximately 40 metres. These cables are shielded to ensure operational safety and compatibility with EMC requirements.
- Fibre optic cables are always used when longer distances have to be bridged or when it would be very difficult to implement the proper shield and ground. Multi-mode cables are designed for distances up to 2 km. Single-mode cables offer a wider range and greater transmission capacity (also refer to bandwidth-length product). POF cables are very easy to assemble on site. Their range is limited, depending on their type, to 50 to 60 metres.

2. What will be transmitted?

- When transmitting Ethernet-based services or protocols with copper lines, you must select the proper category (this of course also applies to the connector being used):
- If fibre optic cables are being used for transmitting Ethernet-based services, then the specifications can be made according to the "Excerpt from ISO/IEC 11 801" table on the next page.
- When using POF, the transmitted automation profile is in accordance with IEC 61784-5 (CP or CPF = Communication Profile or Communication Profile Family). For PROFINET in accordance with IEC 61 784-5-3, 1 mm polymer optical fibre is used.

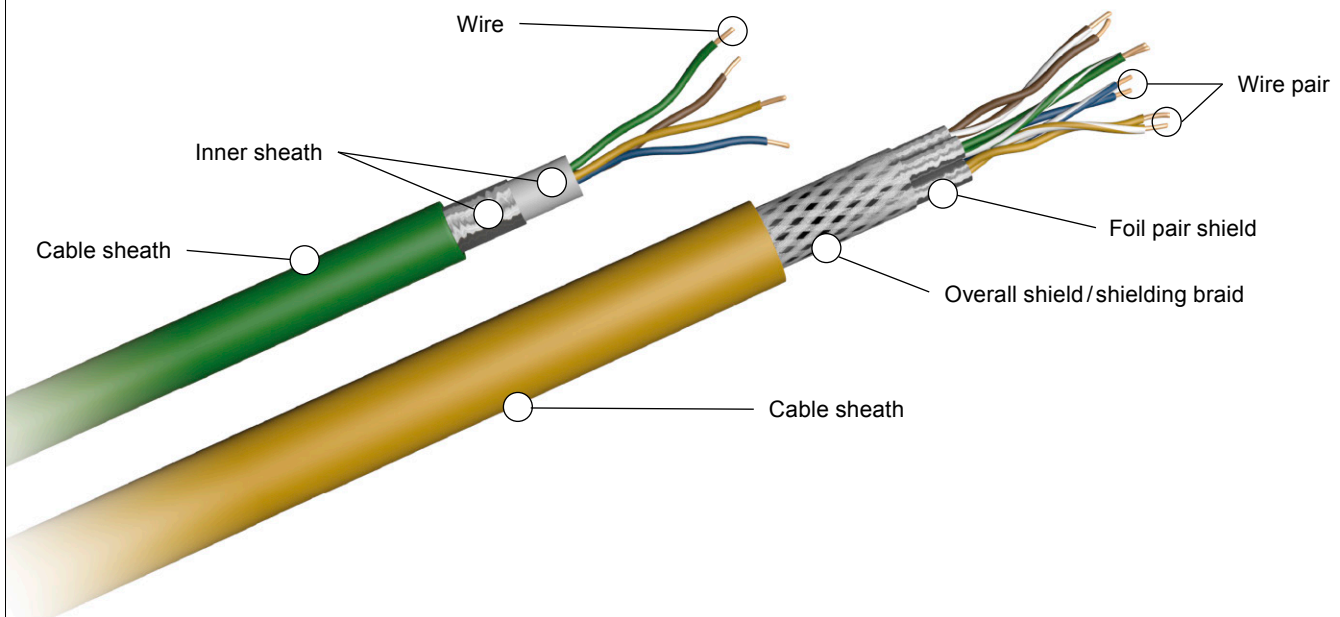

Design of PROFINET star quad (green) and TP cable 4-wire S/FTP -PiMF (yellow)

Category	Bandwidth	Ethernet	Transmission speed	Required number of wires	Transmission class
5	100 MHz	Fast Ethernet	100 Mbit/s	4	D
5/5e	100 MHz	Gigabit Ethernet	1.000 Mbit/s	8	D
6	250 MHz	Gigabit Ethernet	1.000 Mbit/s	8	E
6 _A	500 MHz	10 GB Ethernet	10.000 Mbit/s	8	E _A
7	600 MHz	10 GB Ethernet	10.000 Mbit/s	8	F
7 _A	1.000 MHz	(10 GB Ethernet)	10.000 Mbit/s	8	F _A

3. Where will the cables be installed?

Our users know their installation environment best. The proper cable is specified (in regards to wire/cable construction and sheath material) by properly selecting the requirements for the application and place of use. These specifications are cost-critical factors for ensuring the cable's proper operation and service life.

- Automation environment → Cable specification according to IEC 61784-5 or **HARTING PROFINET cables** according to type A (fixed stationary installation), type B (non-stationary installation), type C (special constructions such as drag chain or torsion cable)

Network application	Max. channel attenuation (dB)		
	Multimode		Singlemode
	850 nm	1300 nm	1310 nm
ISO/IEC/IEEE 8802-3:2017, Clause 9: FOIRL	6.80	-	-
ISO/IEC/IEEE 8802-3:2017, Clauses 15-18: 10BASE-FLand FB	6.80	-	-
ISO/IEC/IEEE 8802-3:2017, Clause 38: 1000BASE-SX ^a	3.56	-	-
ISO/IEC/IEEE 8802-3:2017, Clause 38: 1000BASE-LX ^a	-	2.35	4.56
ISO/IEC/IEEE 8802-3:2017, Clause 26: 100BASE-FX	-	6.00	-
ISO/IEC/IEEE 8802-3:2017, Clause 53: 10GBASE-LX4 ^a	-	2.00	6.20
ISO/IEC/IEEE 8802-3:2017, Clause 68: 10GBASE-LRM ^a	-	1.90	-
ISO/IEC/IEEE 8802-3:2017, Clause 52: 10GBASE-ER	-	-	10.90
ISO/IEC/IEEE 8802-3:2017, Clause 52: 10GBASE-SR ^a	2.60 (OM3) 2.90 (OM4)	-	-
ISO/IEC/IEEE 8802-3:2017, Clause 52: 10GBASE-LR	-	-	6.20
ISO/IEC/IEEE 8802-3:2017, Clause 86: 40GBASE-SR4 ^{a, b}	1.90 (OM3) 1.50 (OM4)	-	-
ISO/IEC/IEEE 8802-3:2017, Clause 87: 40GBASE-LR4	-	-	6.70
ISO/IEC/IEEE 8802-3:2017, Clause 89: 40GBASE-FR	-	-	4.00
ISO/IEC/IEEE 8802-3:2017, Clause 95: 100GBASE-SR4 ^{a, b}	1.80 (OM3) 1.90 (OM4)	-	-
ISO/IEC/IEEE 8802-3:2017, Clause 86: 100GBASE-SR10 ^{a, b}	1.90 (OM3) 1.50 (OM4)	-	-
ISO/IEC/IEEE 8802-3:2017, Clause 88: 100GBASE-LR4	-	-	6.30
ISO/IEC/IEEE 8802-3:2017, Clause 88: 100GBASE-ER4	-	-	18.00
1 Gbit/s FC (1.0625 GBd) ^a	2.62 (OM3)	-	7.80
2 Gbit/s FC (2.125 GBd) ^a	3.31 (OM3)	-	7.80
4 Gbit/s FC (4.25 GBd) ^a	2.88 (OM3) 2.95 (OM4)	-	4.80
8 Gbit/s FC (8.5 GBd) ^a	2.04 (OM3) 2.19 (OM4)	-	6.40
16 Gbit/s FC (14.025 GBd) ^a	1.86 (OM3) 1.95 (OM4)	-	6.40
32 Gbit/s FC ^a	1.75 (OM3) 1.86 (OM4)	-	6.40

^a A bandwidth-limited application at the channel lengths shown. The use of lower attenuation components to produce channels exceeding the values shown cannot be recommended.

^b These are multi-fibre applications and are subject to a delay skew requirement which is met by design if all the optical fibres providing a channel transverse the same cable and cord from end-to-end.

- Connection from a facility/automation island to IT → use **installation cable**
- Outdoor installations → use **HARTING outdoor cable**
- Installation in/on train → use **HARTING EtherRAIL® cable**
- Installation in bus or tram → use **HARTING cable in accordance with ISO 6722:2006** (UN ECE-R 118 Rev.1 + Amdm.1:2013-11)

4. Which connectors or terminating technique will you be using?

The use of certain connector types, if not already specified, is mainly determined by the application. HARTING offers all of the necessary connector types; they are listed in this catalogue according to their applications.

5. What additional requirements must the cabling meet?

If there are additional specific requirements, these need to be checked with the specifications for the cable being used. All of the primary requirements for data cables for special applications are already covered by HARTING's Ethernet cable product portfolio. HARTING's portfolio naturally meets requirements for oil resistance, crush resistance and a wide temperature range for industrial-grade cables. But there may be other crucial requirements which are not covered by our standard designs and must be requested separately, such as resistance to welding beads, special hybrid constructions, etc.

Cable materials

Copper data cables consist of the core material (copper wires or strands, tinned or non-tinned), the core insulation (foamed or non-foamed plastics such as PVC or PE) foils and copper braids for shielding, possibly liners or inner shells (for PROFINET cable), fillers or tension elements, additional foils or layers, and the outer sheath.

All of these cable materials determine the electrical parameters (such as the category), as well as the mechanical, chemical and EMC characteristics.

Unlike connectors, cable may introduce a significant amount of material into a facility or cabling installation. This affects the flammability characteristics and fire loads.

Thus, the materials chosen for the core insulation and the sheath are very important.

The key characteristics of the cable sheath and its material are:

- PVC (polyvinyl chloride): lightweight, highly flexible (soft) material that can be processed well. Very resistant to oils and fats; prevalent in the industrial environment. PVC has a very high flame resistance. If a PVC soot material is added, this makes an excellent sheathing material for outer cable. The addition of soot inevitably leads to black colour and provides the necessary UV resistance for the cable.

PVC is not halogen-free. The disadvantage is that it releases toxic gases during a fire and forms hydrochloric acid when combined with (extinguishing) water which can cause further damage.

- PUR (polyurethane): is a very robust material with excellent characteristics for industrial and industry-related applications. It is halogen-free and has outstanding oil resistance, chemical resistance and abrasion resistance. It also has good flame resistance and is suitable for non-stationary applications.
- PE (polyethylene): has many characteristics similar to PUR, but worse oil resistance and chemical resistance. It is extremely anti-hygroscopic (limited absorption with surrounding water) and safe for use in food processing applications, so it is well suited for HARTING's F+B portfolio.

Elastomer materials (which are similar to PE) have been developed for use in HARTING EtherRail® cables. The elastomer is irradiated, which provides the cable with its excellent temperature and fire characteristics.

- FRNC (Flame Retardant Non-Corrosive) thermoplastic polyolefine: a halogen-free material with excellent flame resistance. FRNC cables can be readily processed and are widely used in structured building cabling (fixed routing, installation cables). For industrial applications, however, FRNC cables are rarely used because of their insufficient resistance to oil and chemicals.

The general term LSZH (Low Smoke Zero Halogen) is often used to describe cables for building installation and structured cabling. LSZH actually describes the properties of the cable sheath and not the real material composition.

Copper wires in data cables

The size, cross section and construction of the copper wire in data cables determine the electrical and hence also the transmission characteristics.

A distinction is made between hard core and stranded wires. Hard core wires are normally used

for stationary installations where the cables hardly move. Stranded wires consist of several individual strands. This is used for making flexible and highly flexible cables; it is well suited for use in non-stationary applications.

The size of the copper wires is indicated in AWG (American Wire Gauge). An overview of the sizes is provided below.

As the wire cross section increases (smaller AWG numbers), the signal attenuation in the cable (IL = Insertion Loss) lowers and the range of the data cable lengthens. This is why PROFINET cables (e.g. type A with four AWG22/1 wires) operate with a 100 metre range and why patch/connecting cables (with only AWG26/7 wire strands) are intended for 20 to 40 metre ranges.

Type 1
(massive copper wire, excerpt from ASTM B286)

AWG					Maximum DC resistance of 20 °C			
AWG specification	Cross-sectional area		Nominal diameter		Tinned surfaces		Bare copper wires or silver-plated surfaces	
	cmils	mm ²	in.	mm	Ω/1000 ft	Ω/km	Ω/1000 ft	Ω/km
22	640	0.324	0.0253	0.643	17.2	56.430	16.5	54.133
24	404	0.205	0.0201	0.511	27.2	89.238	26.2	85.958
26	253	0.128	0.0159	0.404	44.5	145.997	41.9	137.467
28	159	0.081	0.0126	0.320	70.8	232.283	66.8	219.160

Type 2
(stranded copper wire, excerpt from ASTM B286)

Wire construction								Max. DC resistance of 20 °C			
AWG specification	Number of wire cores	Diameter of the individual wires		Calculated cross-sectional area		Maximum permitted diameter		Tinned surfaces		Bare copper wires or silver-plated	
		in.	mm	cmils	mm ²	in.	mm	Ω/1000 ft	Ω/km	Ω/1000 ft	Ω/km
22-19	19	0.0063	0.160	754	0.382	0.033	0.84	15.9	52.165	14.8	48.556
22- 7	7	0.0100	0.254	700	0.355	0.031	0.79	16.7	54.790	15.6	51.181
24-19	19	0.0050	0.127	475	0.241	0.027	0.69	25.4	83.333	23.6	77.428
24- 7	7	0.0080	0.203	448	0.227	0.025	0.64	26.2	85.958	24.5	80.381
26-19	19	0.0040	0.102	304	0.154	0.022	0.56	40.1	131.56	37.3	122.37
26- 7	7	0.0063	0.160	278	0.141	0.020	0.51	42.6	139.76	39.7	130.24
28-19	19	0.0031	0.079	183	0.093	0.017	0.43	67.7	222.11	63.1	207.02
28- 7	7	0.0050	0.127	175	0.089	0.016	0.40	68.2	223.75	63.6	208.66

Cross sections of copper wires

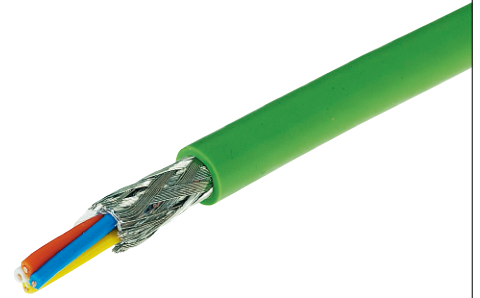

Industrial Cat. 5 standard cable, 4-wire
Type A

Features

- Sheath material PVC
- Category Cat. 5
- Number of wires 4
- Wire design AWG 22/1
- Wire diameter 6.5 mm

Application

- For permanent installation or to build-up PROFINET system cable

Benefits

- Robust design suitable for industry
- PROFINET compliant
- Easy stripping of cable sheath and screening braid with stripping tool 09 45 800 0000
- RoHS compliant

Technical characteristics

Cable structure	Star quad, double shielding
Core structure	4 x AWG 22/1, solid
Wire insulation	PE, Ø 1.5 mm
Sheath material	PVC
Cable sheath diameter	6.5 mm
Transmission performance	Category 5, Class D up to 100 MHz acc. to ISO/IEC 11801, EN 50173-1
Transmission rate	10/100 Mbit/s
Shielding	Shielding foil and shielding braid
Operating temperature range	-40 °C ... +75 °C
Colour	Green
Printing	HARTING specific printing

Identification	Part number PVC	Drawing	Dimensions in mm
Industrial Cat. 5 standard cable Type A, 4-wire	Green		
20 m ring	09 45 600 0130		
50 m ring	09 45 600 0140		
100 m ring	09 45 600 0100		
500 m drum	09 45 600 0110		

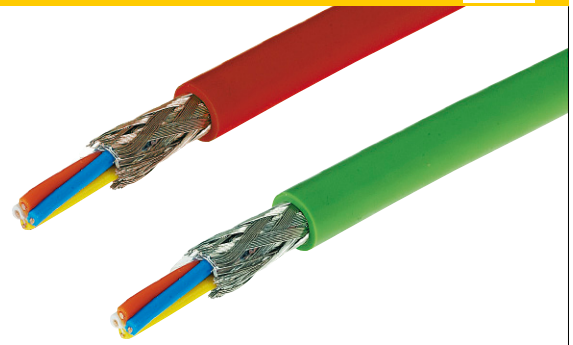

Industrial Cat. 5 stranded cable, 4-wire
Type B

Features

- Sheath material PVC
- Category Cat. 5
- Number of wires 4
- Wire design AWG 22/7
- Wire diameter 6.5 mm

Application

- To build-up PROFINET/SERCOS III system cable

Benefits

- Robust design suitable for industry
- PROFINET compliant (Green)
- SERCOS III compliant (Red)
- Easy stripping of cable sheath and screening braid with stripping tool 09 45 800 0000
- RoHS compliant

Technical characteristics

- Cable structure Star quad, double shielding
- Core structure 4 x AWG 22/7, tinned copper wire, stranded
- Wire insulation PE, Ø 1.56 mm
- Sheath material PVC
- Cable sheath diameter 6.5 mm
- Transmission performance Category 5, Class D up to 100 MHz acc. to ISO/IEC 11801, EN 50 173-1
- Transmission rate 10/100 Mbit/s
- Shielding Shielding foil and shielding braid
- Operating temperature range -40 °C ... +70 °C
- Colour Green (PROFINET)
Red (SERCOS III)
- Printing HARTING specific printing

Cables
4-wire

Identification	Part number		Drawing	Dimensions in mm
	PVC	SERCOS III PVC		
Industrial Cat. 5 stranded cable Type B, 4-wire	Green	Red		
20 m ring	09 45 600 0132	09 45 600 0134		
50 m ring	09 45 600 0142	09 45 600 0144		
100 m ring	09 45 600 0102	09 45 600 0104		
500 m drum	09 45 600 0112	09 45 600 0114		

Other cable lengths on request

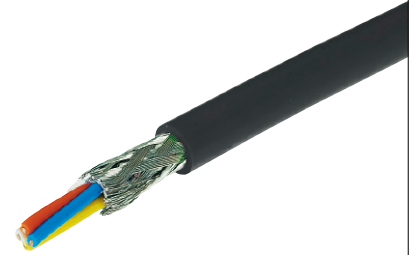

Industrial Cat. 5 stranded cable, 4-wire,
Type B, outdoor

Features

- Sheath material PVC
- Category Cat. 5
- Number of wires 4
- Wire design AWG 22/7
- Wire diameter 6.5 mm

Application

- To build-up PROFINET system cable

Benefits

- Robust design suitable for industry
- PROFINET compliant
- UV protected
- Easy stripping of cable sheath and screening braid with stripping tool 09 45 800 0000
- RoHS compliant

Technical characteristics

Cable structure	Star quad, double shielding
Core structure	4 x AWG 22/7, stranded
Wire insulation	PE, Ø 1.56 mm
Sheath material	PVC
Cable sheath diameter	6.5 mm
Transmission performance	Category 5, Class D up to 100 MHz acc. to ISO/IEC 11801, EN 50173-1
Transmission rate	10/100 Mbit/s
Shielding	Shielding foil and shielding braid
Operating temperature range	-45 °C ... +60 °C
Colour	Black
Printing	HARTING specific printing

Identification	Part number PVC	Drawing	Dimensions in mm
Industrial Cat. 5 stranded cable, 4-wire, Type B, outdoor	Black		
20 m ring	09 45 600 0135		
50 m ring	09 45 600 0145		
100 m ring	09 45 600 0105		
500 m drum	09 45 600 0115		

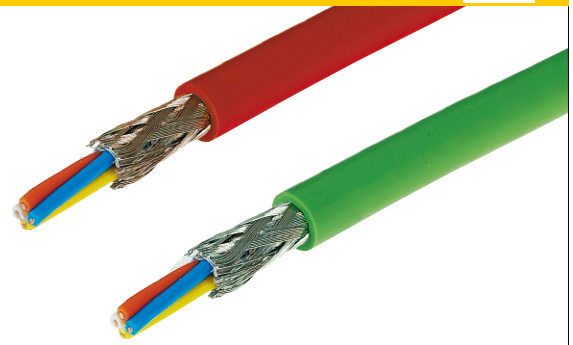

Industrial Cat. 5 stranded cable, 4-wire,
useable as trailing cables,
Type C

Features

- Sheath material PUR
- Category Cat. 5
- Number of wires 4
- Wire design AWG 22/7
- Wire diameter 6.5 mm

Application

- To connect to mobile equipment to build-up PROFINET/SERCOS III system cable

Benefits

- Robust design suitable for industry
- PROFINET compliant (Green)
- SERCOS III compliant (Red)
- Useable as trailing cables
- Easy stripping of cable sheath and screening braid with stripping tool 09 45 800 0000
- RoHS compliant

Technical characteristics

- Cable structure Star quad, double shielding
- Core structure 4 x AWG 22/7, stranded
- Wire insulation PE, Ø 1.5 mm
- Sheath material PUR
- Cable sheath diameter 6.5 mm
- Transmission performance Category 5, Class D up to 100 MHz acc. to ISO/IEC 11801, EN 50 173-1
- Transmission rate 10/100 Mbit/s
- Shielding Shielding foil and shielding braid
- Operating temperature range -40 °C ... +70 °C
- Colour Green (PROFINET)
Red (SERCOS III)
- Printing HARTING specific printing

Cables
4-wire

Identification	Part number		Drawing	Dimensions in mm
	PUR	SERCOS III PUR		
Industrial Cat. 5 stranded cable, 4-wire, useable as trailing cables, Type C	Green	Red		
20 m ring	09 45 600 0131	09 45 600 0137		
50 m ring	09 45 600 0141	09 45 600 0147		
100 m ring	09 45 600 0101	09 45 600 0107		
500 m drum	09 45 600 0111	09 45 600 0117		

Other cable lengths on request



Industrial Cat. 5 stranded cable, 4-wire,
useable as torsion cables,
Type C

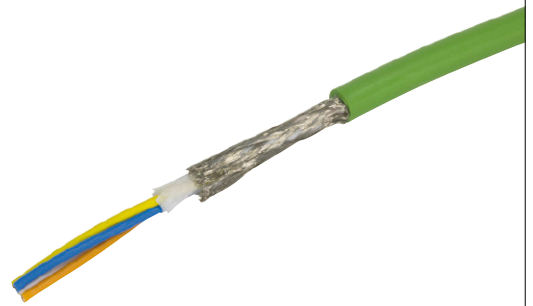

Features

- Sheath material PUR
- Category Cat. 5
- Number of wires 4
- Wire design AWG 22/19
- Wire diameter 6.5 mm

Application

- To connect to mobile equipment to build-up PROFINET system cable

Benefits

- Robust design suitable for industry
- PROFINET compliant (Green)
- Useable as torsion cables
- Easy stripping of cable sheath and screening braid with stripping tool 09 45 800 0000
- RoHS compliant

Technical characteristics

- Cable structure Star quad, double shielding
- Core structure 4 x AWG 22/19, stranded
- Wire insulation PE, Ø 1.52 mm
- Sheath material PUR
- Cable sheath diameter 6.5 mm
- Transmission performance Category 5, Class D up to 100 MHz acc. to ISO/IEC 11801, EN 50173-1
- Transmission rate 10/100 Mbit/s
- Shielding Shielding foil and shielding braid
- Operating temperature range -40 °C ... +80 °C
- Colour Green (PROFINET)
- Printing HARTING specific printing

Identification	Part number	Drawing	Dimensions in mm
----------------	-------------	---------	------------------

Industrial Cat. 5
stranded cable, 4-wire,
useable as torsion cables,
Type C

- 20 m ring
- 50 m ring
- 100 m ring
- 500 m drum

- 09 45 600 1110
- 09 45 600 1120
- 09 45 600 1130
- 09 45 600 1140



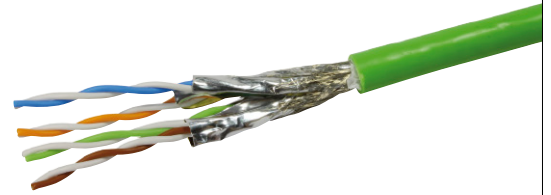

PROFINET 4 TP type A cable, 8-wire, PVC

Features

- Sheath material PVC
- Category Cat. 6A
- Number of wires 8
- Wire design AWG 23/1
- Wire diameter 7.9 mm

Application

This data cable can be used for the cabling acc. to type A of the PROFINET cabling standard. The four pair TP construction allows the transmission of IT data and analog signals such as 10/100 Mbit/s, 10 Gbit/s, video and audio as well as IP data services.

Benefits

- PROFINET compliant (green)
- For fixed installation
- Flame retardant
- RoHS compliant
- Usable for the Fast Ethernet and Gigabit Ethernet data cabling in industrial applications

Technical characteristics

- Cable structure 4 x 2, Twisted Pair, shielded
- Core structure 4 pairs AWG 23/1
- Wire insulation PE, Ø 1.4 mm
- Sheath material PVC
- Cable sheath diameter 7.9 mm
- Transmission performance Category 6A, Class EA up to 500 MHz acc. to EN 50288, IEC 61156
- Transmission rate 10/100 Mbit/s
10 Gbit/s
- Shielding Foil and tinned copper braid
- Operating temperature range
fix operation -20 °C ... +60 °C
flexible operation 0 °C ... +50 °C
- Colour Green

Identification	Part number	Drawing	Dimensions in mm
PROFINET 4 TP type A cable, 8-wire, Cat. 6A, PVC 20 m ring 50 m ring 100 m ring 500 m drum	09 45 600 1200 09 45 600 1210 09 45 600 1220 09 45 600 1230		

Other cable lengths on request

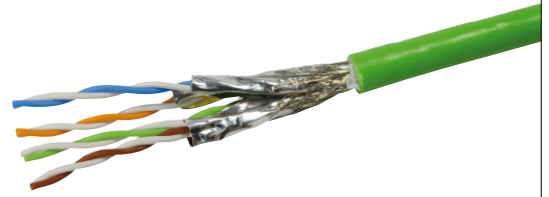

PROFINET 4 TP type B cable, 8-wire, PVC

Features

- Sheath material PVC
- Category Cat. 6_A
- Number of wires 8
- Wire design AWG 23/7
- Wire diameter 8.7 mm

Application

This data cable can be used for the cabling acc. to type B of the PROFINET cabling standard. The four pair TP construction allows the transmission of IT data and analog signals such as 10/100 Mbit/s, 10 Gbit/s, video and audio as well as IP data services.

Benefits

- PROFINET compliant (green)
- Suitable for flexible system cables
- Flame retardant
- RoHS compliant
- Usable for the Fast Ethernet and Gigabit Ethernet data cabling in industrial applications
- UL certified
- UV proof

Technical characteristics

Cable structure	4 x 2, Twisted Pair, shielded
Core structure	4 pairs AWG 23/7
Wire insulation	PE, Ø 1.59 mm
Sheath material	PVC
Cable sheath diameter	8.7 mm
Transmission performance	Category 6 _A , Class E _A up to 500 MHz acc. to EN 50288, IEC 61156
Transmission rate	10/100 Mbit/s 10 Gbit/s
Shielding	Tinned copper braid
Operating temperature range	-40 °C ... +80 °C
Colour	Green

Identification	Part number	Drawing	Dimensions in mm
<p>PROFINET 4 TP type B cable, 8-wire, Cat. 6_A, PVC</p> <p>20 m ring 50 m ring 100 m ring 500 m drum</p>	<p>09 45 600 1211 09 45 600 1221 09 45 600 1231 09 45 600 1241</p>		

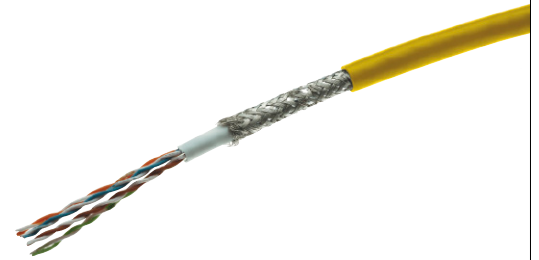

Industrial Cat. 5/Cat. 5e high flexible cable, 8-wire, PUR

Features

- Sheath material PUR
- Category Cat. 5/Cat. 5e
- Number of wires 8
- Wire design AWG 26/19
- Wire diameter 6.8 mm

Application

- Trailing

Benefits

- Robust design suitable for industry
- Usable as trailing cables in drag chains and fit for torsion strength
- Usable for transfer rate up to 1 Gigabit Ethernet
- Halogen free
- Flame retardant
- Free silicone oil
- RoHS compliant

Technical characteristics

- Cable structure 4 x 2, Twisted Pair, shielded
- Core structure 4 x 2 x AWG 26/19
- Wire insulation PE, Ø 1.0 mm
- Sheath material PUR
- Cable sheath diameter 6.8 mm
- Transmission performance Category 5/Category 5e, Class D up to 100 MHz acc. to EN 50 288-2-2:2004, IEC 61 156-6:2002
- Transmission rate 10/100/1000 Mbit/s
- Shielding Overall screen of tinned copper braid
- Operating temperature range
fix operation -40 °C ... +85 °C
flexible operation 0 °C ... +50 °C
- Bending cycles 5 million
- Colour Yellow
- Fit for torsion strength acc. to EN 50 289-3-10

Identification	Part number	Drawing	Dimensions in mm
----------------	-------------	---------	------------------

Industrial Cat. 5/Cat. 5e
installation cable, 8-wire
PUR

20 m ring	09 45 600 0136
50 m ring	09 45 600 0146
100 m ring	09 45 600 0106
500 m drum	09 45 600 0156

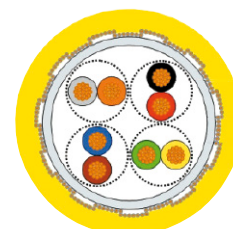



Industrial Cat. 5/Cat. 5e stranded cable, 8-wire, PVC, Outdoor

Features

- Sheath material PVC
- Category Cat. 5/Cat. 5e
- Number of wires 8
- Wire design AWG 26/7
- Wire diameter (6.5 ... 6.9) mm

Application

- To build-up flexible connections (one- or two-sided assembled system cable)

Benefits

- Robust design suitable for industry
- Applicable also for outside applications
- UL, AWM style 2969
- Flame retardant
- Weather proof
- UV resistant
- RoHS compliant
- With Fast Connect inside sheath

Technical characteristics

Cable structure	4 x 2, Twisted Pair, shielded
Core structure	4 x 2 x AWG 26/7
Wire insulation	PE, Ø 1.0 mm
Sheath material	PVC
Cable sheath diameter	6.5 mm ... 6.9 mm
Transmission performance	Category 5/Category 5e, Class D up to 100 MHz acc. to ISO/IEC 11801, EN 50 173-1
Transmission rate	10/100/1000 Mbit/s
Shielding	Foil screen and additional plaited cable
Operating temperature range	
fix operation	-40 °C ... +80 °C
flexible operation	-10 °C ... +60 °C
Colour	Black

Identification	Part number	Drawing	Dimensions in mm
----------------	-------------	---------	------------------

Industrial Cat. 5/Cat. 5e stranded cable, 8-wire, outdoor PVC
20 m ring
50 m ring
100 m ring
500 m drum

09 45 600 0230
09 45 600 0240
09 45 600 0200
09 45 600 0220





Industrial Cat. 6_A cable, stranded, 8-wire, PVC

Features

- Sheath material PVC
- Category Cat. 6_A
- Number of wires 8
- Wire design AWG 26/7
- Wire diameter (6.3 ... 6.9) mm

Application

- To build-up flexible connections (one- or two-sided assembled system cable)

Benefits

- Robust design suitable for industry
- Optimal performance reserves
-  UL, AWM style 20 276
- Flame retardant
- RoHS compliant
- Best useable for all 8-wire HARTING RJ45 connectors

Technical characteristics

Cable structure	4 x 2, Twisted Pair, shielded, PIMF
Core structure	4 x 2 x AWG 26/7
Wire insulation	PE, Ø 1.05 mm
Sheath material	PVC
Cable sheath diameter	6.3 mm ... 6.9 mm
Transmission performance	Category 6 _A , Class E _A up to 500 MHz acc. to ISO/IEC 11801, EN 50 173-1
Transmission rate	10/100 Mbit/s 1/ 10 Gbit/s
Shielding	Paired shielded with additional cable shield
Operating temperature range	-20 °C ... +80 °C
Colour	Yellow

Identification

Industrial Cat. 6_A cable, stranded,
8-wire
PVC

- 20 m ring
- 50 m ring
- 100 m ring
- 500 m drum

Part number

- 09 45 600 0532
- 09 45 600 0542
- 09 45 600 0502
- 09 45 600 0522

Drawing

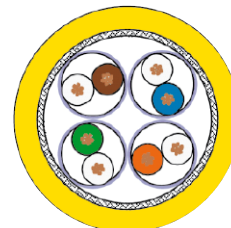

Dimensions in mm



Industrial Cat. 6_A cable, stranded, 8-wire, PUR

Features

- Sheath material PUR
- Category Cat. 6_A
- Number of wires 8
- Wire design AWG 26/7
- Wire diameter (6.3 ... 6.9) mm

Application

- To build-up flexible connections (one- or two-sided assembled system cable)

Benefits

- Robust design suitable for industry
- Optimal performance reserves
- Halogen free
- RoHS compliant
- Flame retardant

Technical characteristics

Cable structure	4 x 2, Twisted Pair, shielded, PIMF
Core structure	4 x 2 x AWG 26/7
Wire insulation	PE, Ø 1.05 mm
Sheath material	PUR
Cable sheath diameter	6.3 mm ... 6.9 mm
Transmission performance	Category 6 _A , Class E _A up to 500 MHz acc. to ISO/IEC 11801, EN 50 173-1
Transmission rate	10/100 Mbit/s 1/ 10 Gbit/s
Shielding	Paired shielded with additional cable shield
Operating temperature range	-40 °C ... +80 °C
Colour	Yellow

Identification	Part number	Drawing	Dimensions in mm
----------------	-------------	---------	------------------

Industrial Cat. 6_A cable, stranded, 8-wire
PUR

- 20 m ring
- 50 m ring
- 100 m ring
- 500 m drum

- 09 45 600 0630
- 09 45 600 0640
- 09 45 600 0600
- 09 45 600 0620

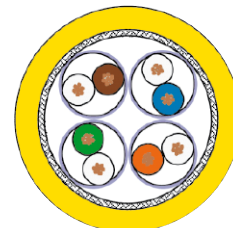



Industrial Cat. 6_A cable, stranded, 8-wire, PVC, Outdoor

Features

- Sheath material PVC
- Category Cat. 6_A
- Number of wires 8
- Wire design AWG 26/7
- Wire diameter (6.3 ... 6.9) mm

Application

- To build-up flexible connections (one- or two-sided assembled system cable)

Benefits

- Robust design suitable for industry
- Optimal performance reserves
- Usable for outdoor applications
- UV proof
- RoHS compliant
- UL, AWM style 20 276
- Flame retardant

Technical characteristics

Cable structure	4 x 2, Twisted Pair, shielded, PIMF
Core structure	4 x 2 x AWG 26/7
Wire insulation	PE, Ø 1.05 mm
Sheath material	PVC
Cable sheath diameter	6.3 mm ... 6.9 mm
Transmission performance	Category 6 _A , Class E _A up to 500 MHz acc. to ISO/IEC 11 801, EN 50 173-1
Transmission rate	10/100 Mbit/s 1/ 10 Gbit/s
Shielding	Paired shielded with additional cable shield
Operating temperature range	-20 °C ... +80 °C
Colour	Black

Identification

Industrial Cat. 6_A stranded cable, 8-wire, Outdoor
PVC

- 20 m ring
- 50 m ring
- 100 m ring
- 500 m drum

Part number

- 09 45 600 0531
- 09 45 600 0541
- 09 45 600 0501
- 09 45 600 0521

Drawing

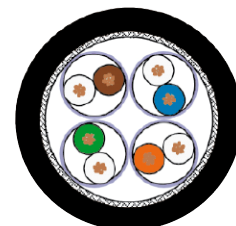

Dimensions in mm



Industrial Cat. 7 sea cable, 8-wire, FRNC

Features

- Sheath material FRNC
- Category Cat. 7
- Number of wires 8
- Wire design AWG 26/7
- Wire diameter 7.1 mm

Application

- Especially suitable for data cabling on and below deck of civil ships as well as other offshore applications

Benefits

- Flame retardant, halogen free and RoHS compliant
- Oil and UV resistant
- Suitable for structured cabling acc. to Cat. 7, class F (ISO/IEC 11801 resp. EN 50173)
- Qualified for the transmission of Gigabit- and 10 Gigabit-Ethernet acc. to IEEE 802.3

Technical characteristics

- Core structure 4 x 2 x AWG 26/7
- Sheath material FRNC
- Cable sheath diameter 7.1 mm
- Transmission performance Cat. 7, Class F up to 600 MHz
- Operating temperature range -40 ... +80 °C
- Colour Black

Identification	Part number	Drawing	Dimensions in mm
----------------	-------------	---------	------------------

Industrial Cat. 7 sea cable, 8-wire
FRNC

100 m ring
500 m reel
1000 m reel

09 45 600 0525
09 45 600 0523
09 45 600 0524

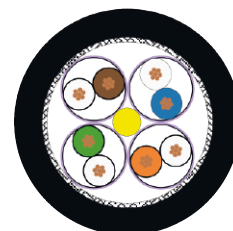

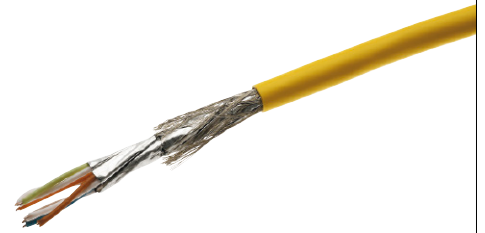

Industrial Cat. 7_A cable, 8-wire, PUR

Features

- Sheath material PUR
- Category Cat. 7
- Number of wires 8
- Wire design AWG 23/1
- Wire diameter 8.3 mm

Application

- To realize fixed connections, e.g. between control cabinet and industrial outlet (on-site installation of cabling for production halls, equipment or automation applications)

Benefits

- Robust design suitable for industry
- Transmission of Gigabit and 10 Gigabit Ethernet acc. IEEE 802.3 and multimedia services
- Flame retardant
- Oil retardant
- RoHS conform
- Halogen free

Technical characteristics

- Cable structure 4 x 2, Twisted Pair, shielded, PIMF
- Core structure 4 x 2 x AWG 23/1, solid copper wire
- Wire insulation PE, Ø 1.4 mm
- Sheath material PUR Elastomer
- Cable sheath diameter 8.3 mm
- Transmission performance Category 7_A, Class F_A up to 1200 MHz acc. to ISO/IEC 11801 and EN 50173-1
- Transmission rate 10/100 Mbit/s
1/ 10 Gbit/s
- Shielding Paired shielded with additional cable shield
- Operating temperature range
fix operation -40 °C ... +70 °C
flexible operation -10 °C ... +50 °C
- Colour Yellow

Identification	Part number	Drawing	Dimensions in mm
----------------	-------------	---------	------------------

Industrial Cat. 7_A
installation cable, 8-wire
PUR

100 m ring
500 m reel
1000 m reel

09 45 600 0651
09 45 600 0650
09 45 600 0660

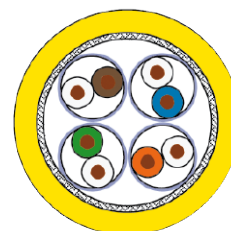



Industrial data cable, 8-wire, Cat. 7_A, PUR

Features

- Sheath material PUR
- Category Cat. 7_A
- Number of wires 8
- Wire design AWG 26/7
- Wire diameter (6.3 ... 6.9) mm

Application

- To build-up flexible connections (one- or two-sided assembled system cable)

Benefits

- Robust design suitable for industry
- Optimal performance reserves
- Flame retardant
- Halogen free
- RoHS compliant
- Oil retardant

Technical characteristics

Cable structure	4 x 2, Twisted Pair, shielded, PIMF
Core structure	4 x 2 x AWG 26/7
Wire insulation	PE, Ø 1.05 mm
Sheath material	PUR
Cable sheath diameter	6.3 mm ... 6.9 mm
Transmission performance	Category 7 _A , Class F _A up to 1200 MHz acc. to ISO/IEC 11801, EN 50 173-1
Transmission rate	10/100 Mbit/s 1/ 10 Gbit/s
Shielding	Paired shielded with additional cable shield
Operating temperature range	fix operation -40 °C ... +70 °C flexible operation -10 °C ... +50 °C
Colour	Yellow

Identification	Part number	Drawing	Dimensions in mm
----------------	-------------	---------	------------------

Industrial data cable
8-wire, Cat. 7_A
PUR

100 m ring
500 m reel
1000 m reel

09 45 600 0711
09 45 600 0721
09 45 600 0751

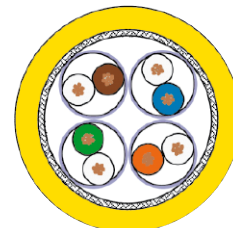



Directory Chapter 03

Page

General information	03.02
M12 connector D-coding	03.06
M12 connector X-coding	03.20
RJ45 IP20 connector	03.28
HARTING ix Industrial®	03.47
PushPull RJ45 IP65/IP67 connector	03.51
Han® 3 A RJ45 IP65/IP67 connector	03.72
Han® 3 A RJ45 Hybrid IP65/IP67 connector	03.87
Han® 3 A LC duplex Hybrid connector	03.97
Han-Modular® connector	03.98
<i>har</i> -port coupler	03.104

All relevant data connectors that, in conjunction with HARTING's data cables (refer to chapter 02), support Fast Ethernet, Gigabit Ethernet and 10 Gigabit Ethernet are listed in the termination and connection technology chapter.

Housings, junction boxes, 19" rails and DIN rail distribution are also listed along with their complementary connectors.

All HARTING cabling solutions for Ethernet (and the corresponding termination and connection technology), are fully screened so they guarantee reliable data transmissions for all installation locations and under all operating conditions.

The HARTING Ethernet connectivity products come with insulation displacement technology (IDC) as well as with crimp technology; so they can be installed on-site at any time.

The preLink® is a special type of IDC termination technology developed by HARTING which enables you to quickly connect a terminating block in a single operation to all eight cable wires and then attach the desired connector (RJ45 or M12, male or female).

The RJ45 connectors are very important; they are constructed according to IEC 60 603-7-x (where x

indicates the male/female version, so that Category 5 to 100 MHz, shielded → x = 3, Category 6 up to 250 MHz, shielded → x = 5 or Category 6A to 500 MHz, shielded → x = 51).

RJ45 connectors are available in many different variants, especially for IP20 area applications. By adding the corresponding protective housing, the RJ45 connectors can be upgraded for use in IP65 / IP67 environments. These are then:

- RJ45 Han® PushPull (PROFINET interface)
- RJ45 Han® 3 A (a standard in the industry, PROFINET interface)
- RJ45 HARTING PushPull (interface for structured building cabling according to ISO/IEC 11 801), a space-saving variant
- RJ45 hybrid solutions (PROFINET interface)

In addition to the RJ45, the M12 mating profile also plays an important role in Ethernet cabling. The M12 D-coded connector has been designed for the transmission of (four wire) Fast Ethernet. The M12 X-coded connector is best suited for transmitting Gigabit or 10 GB (eight wire) Ethernet. M12 connectors with crimp terminations also play a very important role in railway technology. All M12 connectors are IP65 / IP67 compatible.

Specifications

IEC 61076-2-101, IEC 61076-2-109, 

M12 circular connectors

D-coding, mating face acc. to IEC 61076-2-101

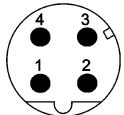

Male, 4 poles

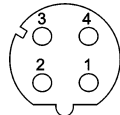

Female, 4 poles

X-coding, mating face acc. to IEC 61076-2-109

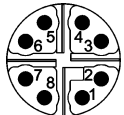

Male, 8 poles



Female, 8 poles

X-coding, mating face acc. to IEC 61076-2-109



8 poles pin assignment

Signals		Pin assignment			Cable		
1/10Gbit	10/100 Mbit	RJ45	M12 D-coded	M12 X-coded	4-wire	568A	568B
BI_DA+	TxData+	1	1	1	yellow	white/green	white/orange
BI_DA-	TxData-	2	3	2	orange	green	orange
BI_DB+	RxData+	3	2	3	white	white/orange	white/green
BI_DC+	-	4	-	8		blue	blue
BI_DC-	-	5	-	7		white/blue	white/blue
BI_DB-	RxData-	6	4	4	blue	orange	green
BI_DD+	-	7	-	5		white/brown	white/brown
BI_DD-	-	8	-	6		brown	brown

Adapter M12/RJ45

4 poles pin assignment

10/100 Mbit	RJ45	M12 D-coded	4-wire
TxData+	1	1	yellow
TxData-	2	3	orange
RxData+	3	2	white
RxData-	6	4	blue

Stromlaufplan
circuit diagram

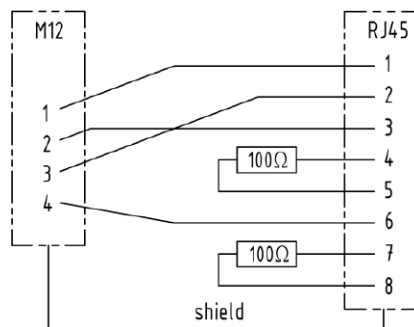

Connecting hardware

Adapter M12/RJ45

8 poles pin assignment

M12	RJ45
1	1
2	2
3	3
4	6
5	7
6	8
7	5
8	4

circuit diagram

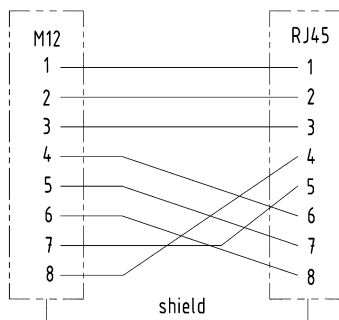

Gender changer

4 poles



schematic diagram

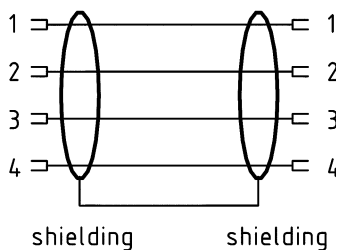

4 poles / 8 poles



schematic diagram

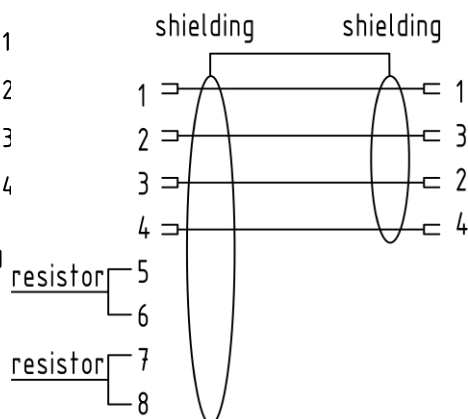

8 poles



schematic diagram

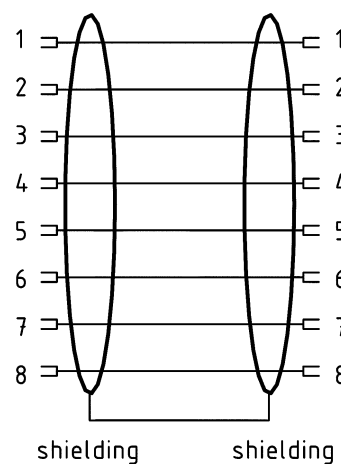



Mating face

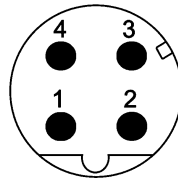

D-coding
Mating face
acc. to IEC 61076-2-101



Advantages

- D-coding for Ethernet/Profinet applications
- Robust design
- 360° screen contact
- Transmission performance acc. Cat. 5
- Field assembly by the use of **HARAX**® IDC termination technology

Technical characteristics

Conductor cross section	0.14 - 0.34 mm ² , AWG 26-22 0.34 - 0.5 mm ² , AWG 22-20
Conductor insulation material	PVC/PE
Conductor diameter	1.2 - 2.0 mm
Cable diameter	4.5 - 8.8 mm
Temperature range	-40 °C ... +85 °C
Degree of protection	IP65/67
Mating cycles	100
Tightening torque connector/ Hexagonal wrench	0.6 Nm/SW 17
Rated current	4 A
Rated voltage	50 V
Contact resistance	10 mΩ
Insulation resistance	10 ⁸ Ω
Transmission performance	Cat. 5
Contact material	Brass
Housing material	PA unreinforced

Connecting hardware

Identification	Part number	Drawing	Dimensions in mm
----------------	-------------	---------	------------------

HARAX® M12-L, shielded



Male
4 poles, D-coding
0.14 - 0.34 mm², AWG 26 - 22

21 03 281 1405

Male
4 poles, D-coding
0.34 - 0.5 mm², AWG 22 - 20

21 03 282 1405

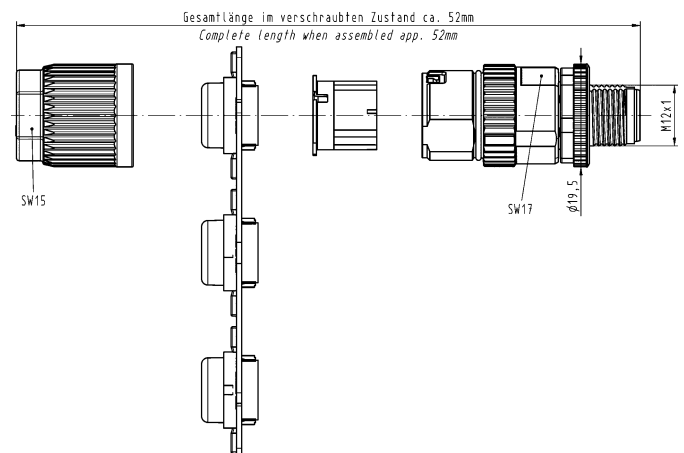



Mating face

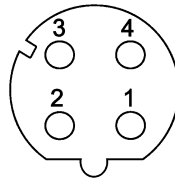

D-coding
Mating face
acc. to IEC 61076-2-101



Identification	Part number	Drawing	Dimensions in mm
----------------	-------------	---------	------------------

HARAX® M12-L, shielded



Female
4 poles, D-coding
0.14 - 0.34 mm², AWG 26 - 22

21 03 281 2405

Female
4 poles, D-coding
0.34 - 0.5 mm², AWG 22 - 20

21 03 282 2405

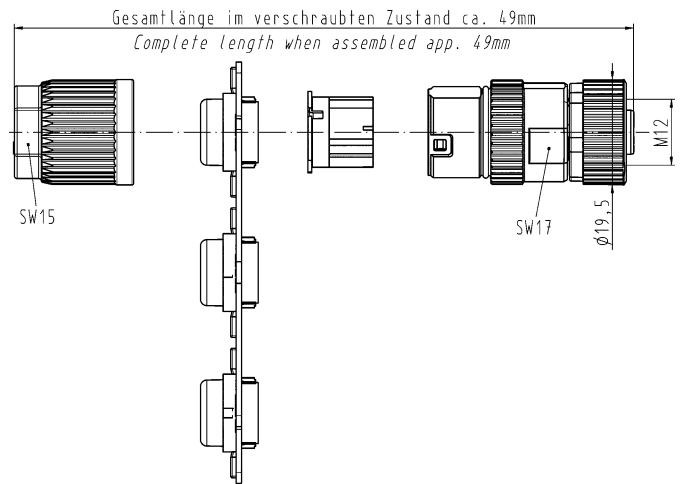



Mating face

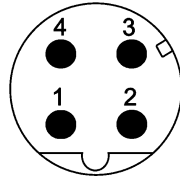

D-coding
Mating face
acc. to IEC 61076-2-101



Identification Part number Drawing Dimensions in mm

HARAX® Panel feed-through



21 03 381 1425

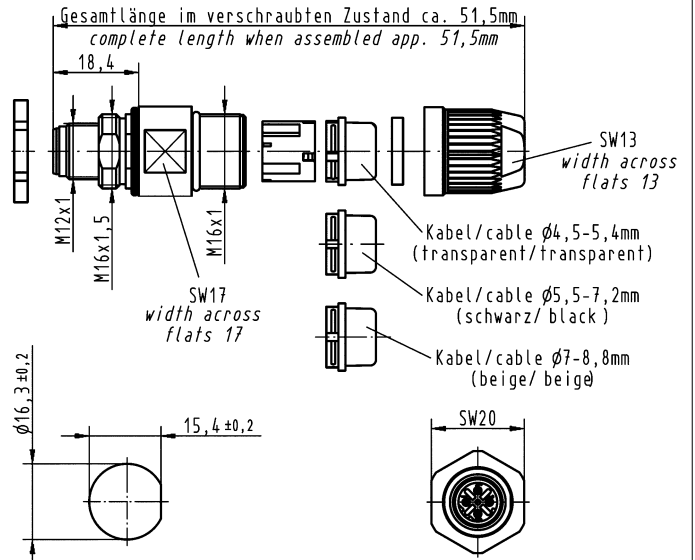

Male
4 poles, D-coding
0.14 - 0.34 mm²/AWG 26 - 22

Panel thickness
min. 2.5 mm
max. 4.5 mm

Connecting hardware



Mating face

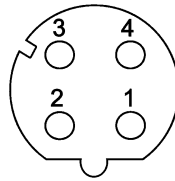

D-coding
Mating face
acc. to IEC 61076-2-101



Identification

Part number

Drawing

Dimensions in mm

HARAX® Panel feed-through



21 03 381 2425

Female
4 poles, D-coding
0.14 - 0.34 mm²/AWG 26 - 22

Panel thickness
min. 2.5 mm
max. 4.5 mm

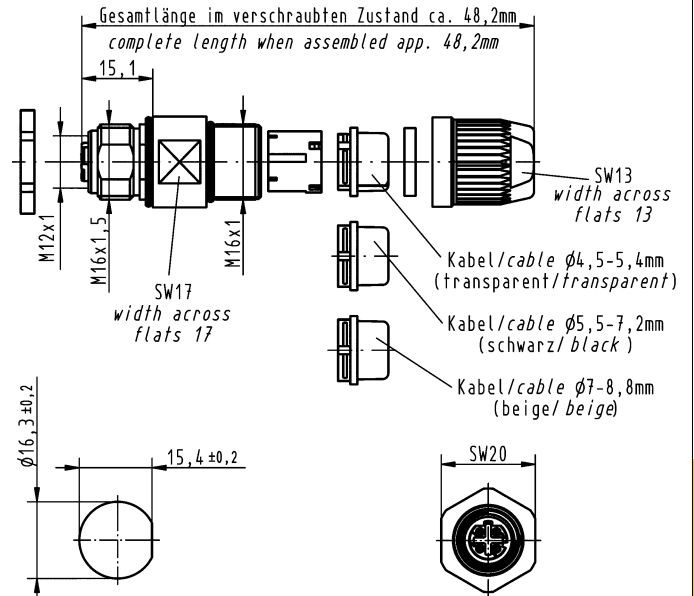



Mating face

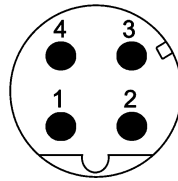

D-coding
Mating face
acc. to IEC 61076-2-101



Advantages

- D-coding for Ethernet/Profinet applications
- Robust design
- 360° screen contact
- Transmission performance acc. Cat. 5
- Very robust **crimp** termination technology

Technical characteristics

Conductor cross section	0.13 - 0.75 mm ² , AWG 26-18
Conductor diameter	2.0 - 2.3 mm
Cable diameter	4.5 - 8.8 mm
Temperature range	-40 °C ... +85 °C
Degree of protection	IP67
Mating cycles	500
Tightening torque connector/ Hexagonal wrench	0.6 Nm/SW 17
Rated current	4 A
Rated voltage	250 V
Contact resistance	10 mΩ
Insulation resistance	10 ⁸ Ω
Transmission performance	Cat. 5
Contact material	Brass
Housing material	PA

Connecting hardware

Identification	Part number	Drawing	Dimensions in mm
<p>M12 Crimp, shielded</p> <p>Male 4 poles, D-coding</p>	21 03 882 1415	<p>Gesamtlänge im verschraubten Zustand ca. 45,0mm complete length when assembled app. 45,0mm</p> <p>Montagehilfe wird lose beigelegt assembly aid enclosed</p>	
<p>M12 Crimp, shielded</p> <p>Male 4 poles, D-coding angled</p>	21 03 882 3405	<p>length when assembled app. 61,9</p> <p>length when assembled app. 45,3</p> <p>length when assembled app. 37,5</p> <p>assembly aid enclosed</p>	



Mating face

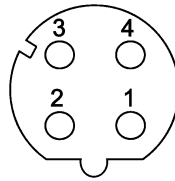

D-coding
Mating face
acc. to IEC 61076-2-101



Identification

Part number

Drawing

Dimensions in mm

M12 Crimp, shielded



Female
4 poles, D-coding

21 03 882 2405

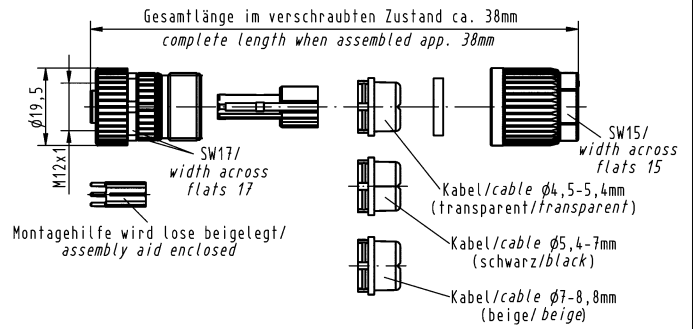



Mating face

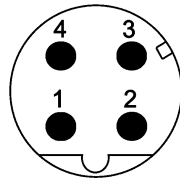

D-coding
Mating face
acc. to IEC 61076-2-101



Identification

Part number

Drawing

Dimensions in mm

M12 Crimp Slim design,
shielded



Male
4 poles, D-coding
Cable: 5.7 - 8.8 mm
outer diameter

21 03 881 1405

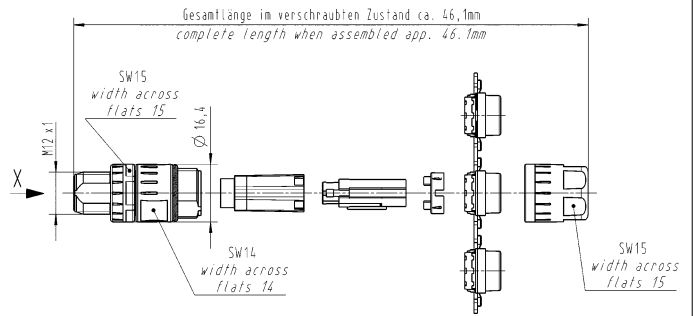

Male
4 poles, D-coding
angled

21 03 881 3405

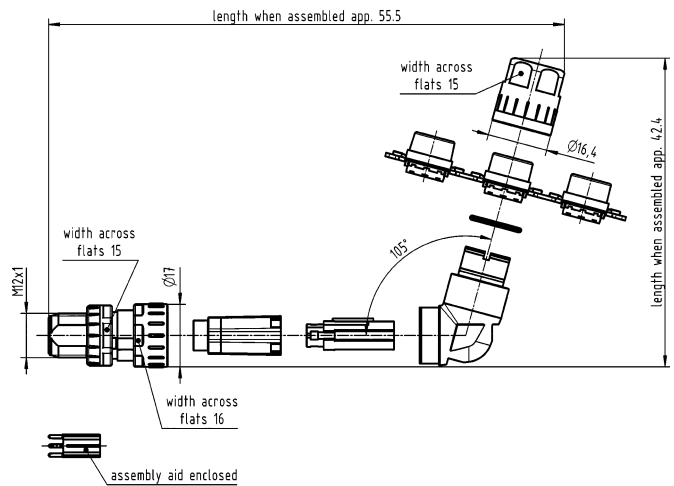



Mating face

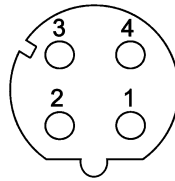

D-coding
Mating face
acc. to IEC 61076-2-101



Identification

Part number

Drawing

Dimensions in mm

M12 Slim Design



Female
4 poles, D-coding
straight

21 03 881 2405

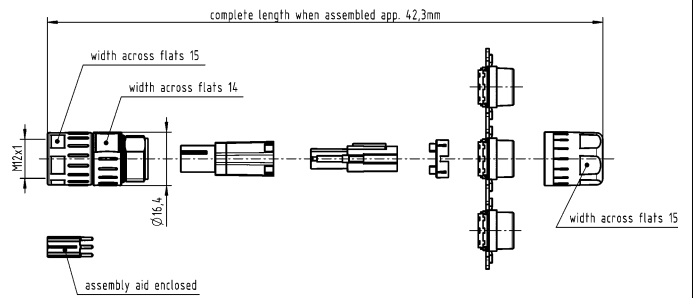

Female
4 poles, D-coding
angled

21 03 881 4405

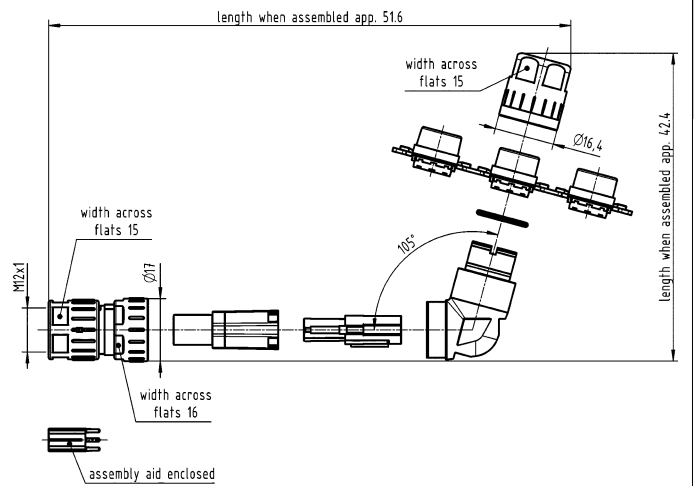



Mating face

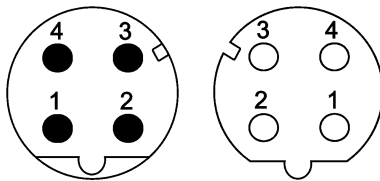

D-coding
Mating face
acc. to IEC 61076-2-101



Identification

Part number

Drawing

Dimensions in mm

M12 Panel feed-through Crimp



Male
4 poles, D-coding

Panel thickness
min. 2.5 mm
max. 4.5 mm

21 03 882 1425

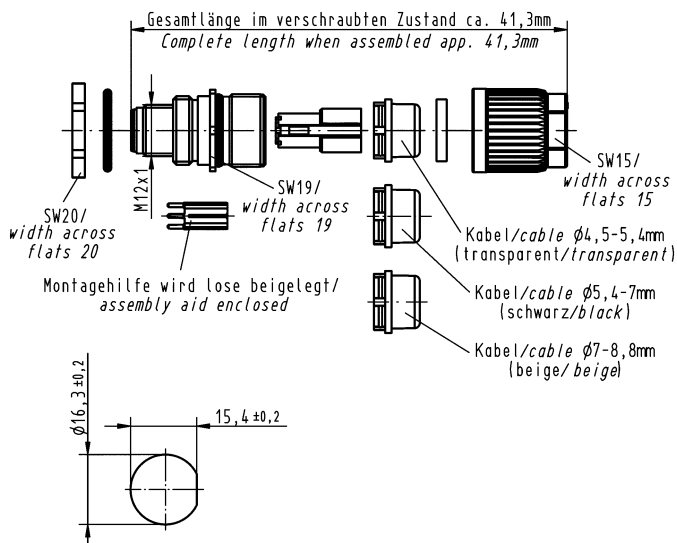

M12 Panel feed-through Crimp



Female
4 poles, D-coding

Panel thickness
min. 2.5 mm
max. 4.5 mm

21 03 882 2425

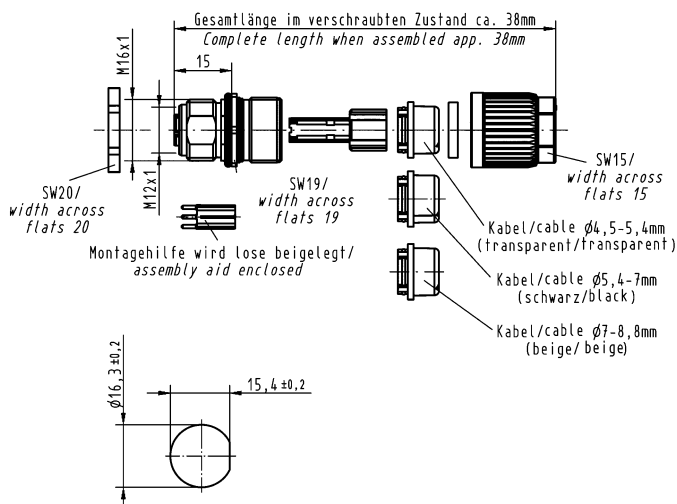

Connecting hardware



Mating face

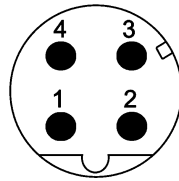

D-coding
Mating face
acc. to IEC 61076-2-101





Advantages

- M12 Ethernet-Data connector suitable for industry
- Robust design
- 360° shielding
- Category of transmission Cat. 5
- Suitable for solid and stranded wires
- Suitable for PoE (IEEE 802.3af) and PoE+ (IEEE 802.3at)
- Very fast **preLink®** termination technology

Technical characteristics

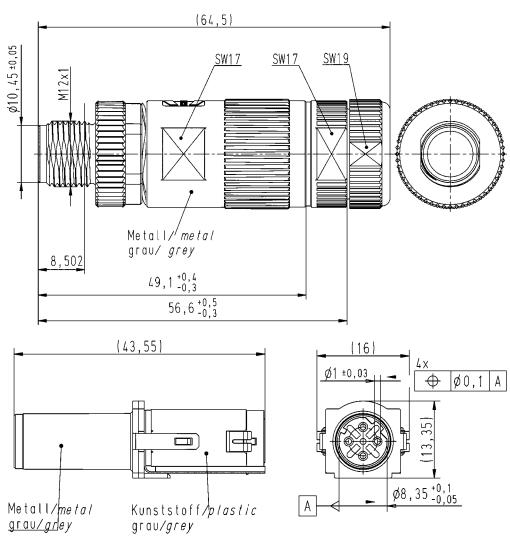
Connector type	M12 D-coded acc. to IEC 61076-2-101
Number of contacts	4
Transmission category	Category 5, Class D, suitable for 10/100 Mbit/s
Transmission performance	Category 5, Class D up to 100 MHz acc. to ISO/IEC 11801, EN 50 173-1
Transmission rate	10/100 Mbit/s
Shielding	fully shielded, 360° shielding contact
Mounting	preLink® IDC termination
Cable termination for preLink® terminal module, yellow, 20 82 000 0001	
Connectable cables	
– Conductor cross section	AWG 23 ... AWG 22 (solid and stranded)
– Conductor diameter	1.3 ... 1.6 mm
Cable termination for preLink® terminal module, white, 20 82 000 0003	
Connectable cables	
– Conductor cross section	AWG 27 ... AWG 26 (solid and stranded)
– Conductor diameter	0.8 ... 1.1 mm
Cable diameter	5.0 ... 9.5 mm
Degree of protection	IP65/IP67
Mating cycles	min. 500
Temperature range	-40 °C ... +85 °C
Housing material	Zinc die-cast, nickel-plated

Identification	Part number	Drawing	Dimensions in mm
preLink® M12 housing 	20 82 000 1210		
preLink® M12 male module Male 4 poles, D-coding 	20 82 005 1214		
preLink® M12 connector set D-coded	20 82 005 0001		
preLink® RJ45 terminal module AWG 22/23, yellow ¹⁾ AWG 26/27, white ¹⁾	20 82 000 0001 20 82 000 0003		
preLink® assembly tool	20 82 000 9901		

Further information and data sheets see www.HARTING.com

¹⁾ Packaging with 10 pieces



Mating face

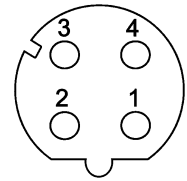

D-coding
Mating face
acc. to IEC 61076-2-101

preLink® M12 cable jack
D-coded

Advantages

- M12 Ethernet-Data connector suitable for industry
- Robust design
- 360° shielding
- Category of transmission Cat. 5
- Suitable for solid and stranded wires
- Suitable for PoE (IEEE 802.3af) and PoE+ (IEEE 802.3at)
- Very fast preLink® termination technology

Technical characteristics

Connector type	M12 D-coded acc. to IEC 61076-2-101
Number of contacts	4
Transmission category	Category 5, Class D, suitable for 10/100 Mbit/s
Transmission performance	Category 5 / Class D up to 100 MHz acc. to ISO/IEC 11801, EN 50173-1
Transmission rate	10/100 Mbit/s
Shielding	fully shielded, 360° shielding contact
Mounting	preLink® IDC termination
Cable termination for preLink® terminal module, yellow, 20 82 000 0001 and black, 20 82 000 0005 resp. 20 82 000 0005 XL	
Connectable cables	
– Conductor cross section	AWG 23 ... AWG 22 (solid and stranded)
– Conductor diameter	1.3 ... 1.6 mm
Cable termination for preLink® terminal module, white, 20 82 000 0003	
Connectable cables	
– Conductor cross section	AWG 27 ... AWG 26 (solid and stranded)
– Conductor diameter	0.8 ... 1.1 mm
Cable diameter	5.0 ... 9.5 mm
Degree of protection	IP65/IP67
Mating cycles	min. 500
Temperature range	-40 °C ... +85 °C
Housing material	Zinc die-cast, nickel-plated

Connecting hardware

Identification	Part number	Drawing	Dimensions in mm
preLink® M12 cable jack set D-coding	20 82 005 2001		
preLink® terminal module AWG 22/23, yellow ¹⁾ AWG 26/27, white ¹⁾ AWG 22/23, black ¹⁾ , 4 poles AWG 22/23, black ²⁾ , 4 poles	20 82 000 0001 20 82 000 0003 20 82 000 0005 20 82 000 0005 XL		
preLink® assembly tool	20 82 000 9901		

¹⁾ Packaging with 10 pieces

²⁾ Packaging with 100 pieces



Mating face

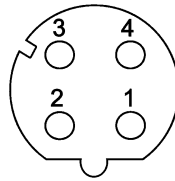

D-coding
Mating face
acc. to IEC 61076-2-101



Identification	Part number	Drawing	Dimensions in mm
----------------	-------------	---------	------------------

M12 Gender changer
Female-Female

4 poles, D-coding
8 poles, X-coding

21 03 381 6402

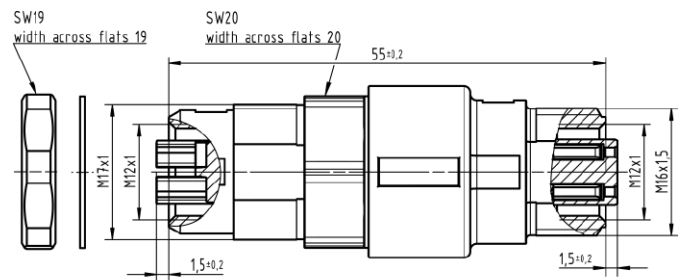

M12 Gender changer
Female-Female

4 poles, D-coding
Cat. 5

21 03 381 6401

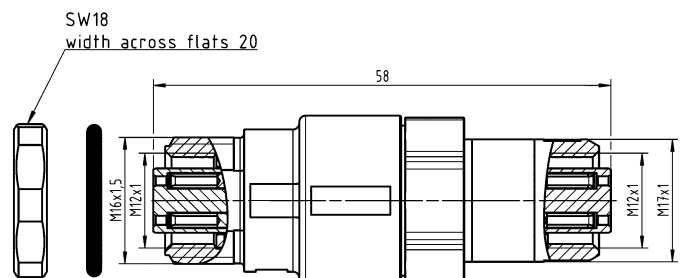

Wall bracket



21 01 000 0036

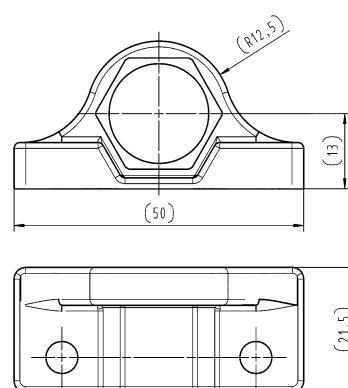



Mating face

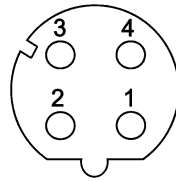

D-coding
Mating face
acc. to IEC 61076-2-101



Identification	Part number	Drawing	Dimensions in mm
----------------	-------------	---------	------------------

M12 Female-RJ45
Panel feed-through



4 poles, D-coding
angled

Panel thickness
min. 2.1 mm
max. 4.5 mm

21 03 381 4401*

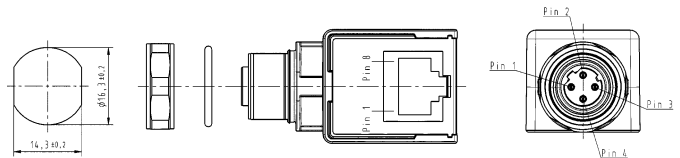

RJ45	M12 D-coded
1	1
2	3
3	2
6	4

M12 Female-RJ45
Panel feed-through



4 poles, D-coding
straight

Panel thickness
min. 2.1 mm
max. 4.5 mm

21 03 381 2401*

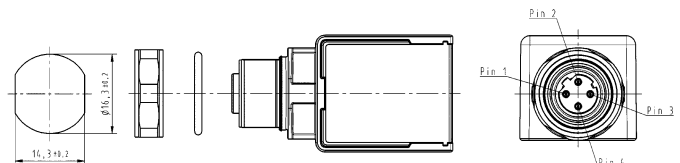

Connecting hardware

Identification	Part number	Drawing																								
<p>Crimping tool for M12 Crimp</p>	09 99 000 0501																									
<p>Accessories M12 Crimp</p> <p>Locator</p> <p>D-Sub single contacts (500 mating cycles)</p> <p>turned male contacts</p> <p>AWG 22-18/0.33-0.82 mm² 09 67 000 3576</p> <p>AWG 24-20/0.25-0.52 mm² 09 67 000 8576</p> <p>AWG 26-22/0.13-0.33 mm² 09 67 000 5576</p> <p>AWG 28-24/0.09-0.25 mm² 09 67 000 7576</p> <p>turned female contacts</p> <p>AWG 22-18/0.33-0.82 mm² 09 67 000 3476</p> <p>AWG 24-20/0.25-0.52 mm² 09 67 000 8476</p> <p>AWG 26-22/0.13-0.33 mm² 09 67 000 5476</p> <p>AWG 28-24/0.09-0.25 mm² 09 67 000 7476</p>	09 99 000 0531	<p>D-Sub contacts</p> <table border="1"> <thead> <tr> <th>Part number</th> <th>AWG</th> <th>Tool settings</th> </tr> </thead> <tbody> <tr> <td rowspan="3">09 67 000 3x76</td> <td>18</td> <td>6</td> </tr> <tr> <td>20</td> <td>6</td> </tr> <tr> <td>22</td> <td>5</td> </tr> <tr> <td>09 67 000 8x76</td> <td>20, 22, 24</td> <td>6</td> </tr> <tr> <td>09 67 000 5x76</td> <td>22, 24, 26</td> <td>6</td> </tr> </tbody> </table> <table border="1"> <thead> <tr> <th></th> <th>a</th> </tr> </thead> <tbody> <tr> <td>AWG 22-18</td> <td>1.34</td> </tr> <tr> <td>AWG 24-20</td> <td>1.13</td> </tr> <tr> <td>AWG 26-22</td> <td>0.88</td> </tr> </tbody> </table>	Part number	AWG	Tool settings	09 67 000 3x76	18	6	20	6	22	5	09 67 000 8x76	20, 22, 24	6	09 67 000 5x76	22, 24, 26	6		a	AWG 22-18	1.34	AWG 24-20	1.13	AWG 26-22	0.88
Part number	AWG	Tool settings																								
09 67 000 3x76	18	6																								
	20	6																								
	22	5																								
09 67 000 8x76	20, 22, 24	6																								
09 67 000 5x76	22, 24, 26	6																								
	a																									
AWG 22-18	1.34																									
AWG 24-20	1.13																									
AWG 26-22	0.88																									
<p>M12 dynamometric screwdriver</p> <p>Tightening torque 0.6 Nm</p> <p>for M12 Slim design SW 15 09 99 000 0646</p> <p>for M12-L SW 17 09 99 000 0384</p>																										
<p>Set of seals M12-L shielded</p> <p>for 4.5 - 5.4 mm cable Ø</p> <p>for 5.4 - 7.2 mm cable Ø</p> <p>for 7.2 - 8.8 mm cable Ø</p>	21 01 010 2017																									
<p>Accessories M12</p> <p>Lock nut</p>	21 01 000 0018																									



Mating face

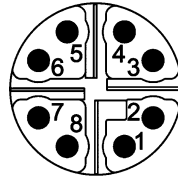

X-coding
Mating face
acc. to IEC 61076-2-109



Advantages

- Maximum data rates through the configuration of the contacts in conformance with Ethernet technology. Transfer class E_A for 1 and 10 Gigabit
- Perfect shielding through paired shielding of the contacts
- Overmoulded system cables in various lengths
- Very robust **crimp** termination technology

Technical characteristics

Conductor cross section	0.08 - 0.25 mm ² , AWG 28-23
Cable diameter	5.7 - 8.8 mm
Temperature range	-40 °C ... +85 °C
Degree of protection	IP65/IP67
Mating cycles	500
Recommended tightening torque/ Hexagonal wrench	0.6 Nm/SW 15
Rated current	0.5 A
Rated voltage	48 V
Transmission performance	Cat. 6 _A
Contact material	Brass
Housing material	ZP410

Connecting hardware

Identification	Part number	Drawing	Dimensions in mm
----------------	-------------	---------	------------------

har-speed M12 Slim design



Male
straight version
8 poles, Cat. 6_A
Cable diameter: 5.7 - 8.8 mm

21 03 881 1805



Male
angled version
8 poles, Cat. 6_A
Cable diameter: 5.7 - 8.8 mm

21 03 881 3805

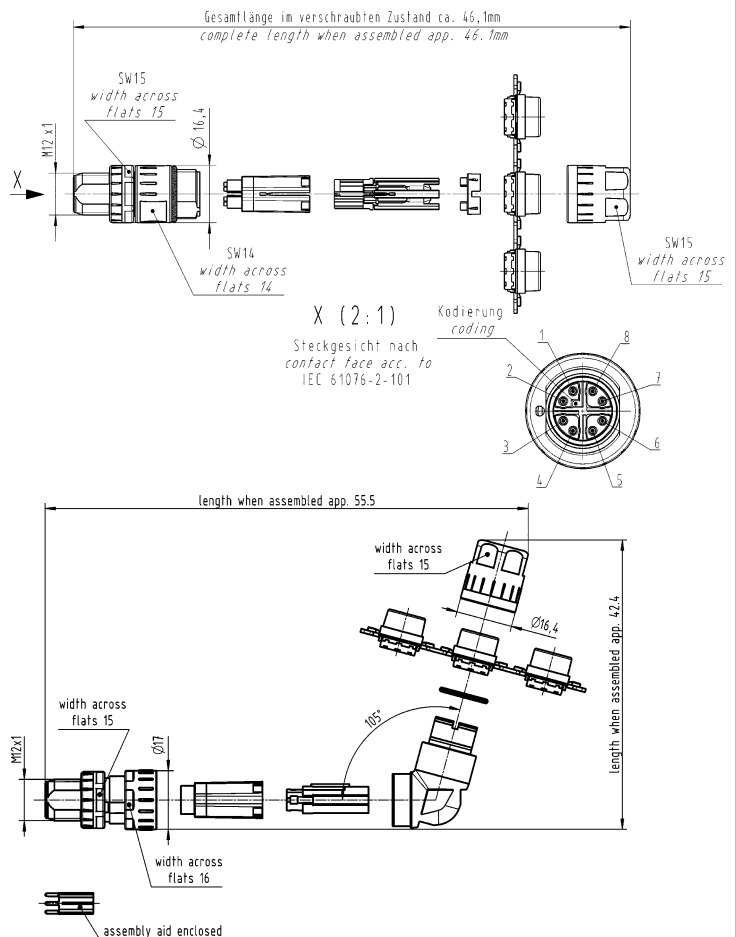

Mating face

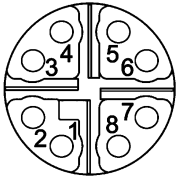

X-coding
Mating face
acc. to IEC 61 076-2-109



Identification

Part number

Drawing

Dimensions in mm

M12 Slim Design



Female,
straight version

8 poles, X-coding
0.08 - 0.25 mm²
AWG 28 - 23

21 03 881 2805

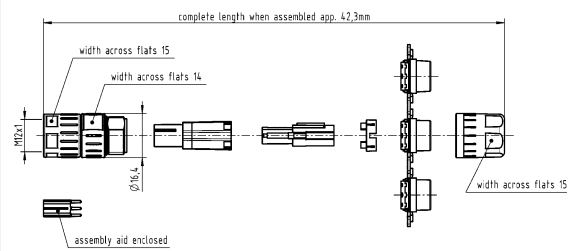

Female,
angled version

8 poles, X-coding
0.08 - 0.25 mm²
AWG 28 - 23

21 03 881 4805

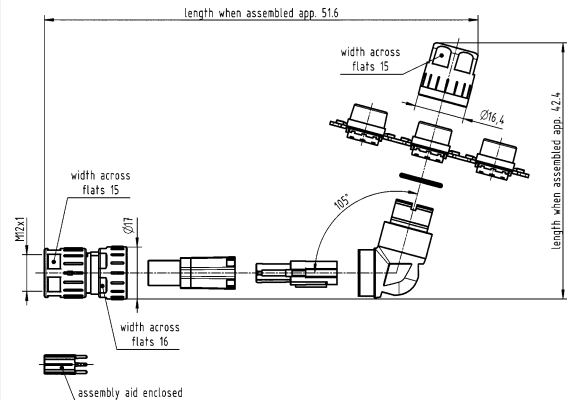



Mating face

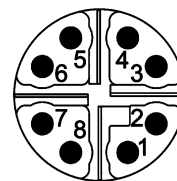

X-coding Mating face acc. to IEC 61076-2-109

preLink® M12 connector X-coded

Advantages

- M12 Ethernet-Data connector suitable for industry
- Robust design
- 360° shielding
- Category of transmission Cat. 6A
- Suitable for solid and stranded wires
- Suitable for PoE (IEEE 802.3af) and PoE+ (IEEE 802.3at)
- Very fast preLink® termination technology

Technical characteristics

Connector type	M12 X-coded acc. to IEC 61076-2-109
Number of contacts	8
Transmission category	Category 6A, Class E _A , suitable for 1/10 Gigabit Ethernet
Transmission performance	Category 6A, Class E _A up to 500 MHz acc. to ISO/IEC 11801, EN 50173-1
Transmission rate	10/100 Mbit/s and 1/10 Gbit/s
Shielding	fully shielded, 360° shielding contact
Mounting	preLink® IDC termination
Cable termination for preLink® Connectable cables	terminal module, yellow, 20 82 000 0001
– Conductor cross section	AWG 23 ... AWG 22 (solid and stranded)
– Conductor diameter	1.3 ... 1.6 mm
Cable termination for preLink® Connectable cables	terminal module, white, 20 82 000 0003
– Conductor cross section	AWG 27 ... AWG 26 (solid and stranded)
– Conductor diameter	0.8 ... 1.1 mm
Cable diameter	5.0 ... 9.5 mm
Degree of protection	IP65/IP67
Mating cycles	min. 500
Temperature range	-40 °C ... +70 °C
Housing material	Zinc die-cast, nickel-plated

Connecting hardware

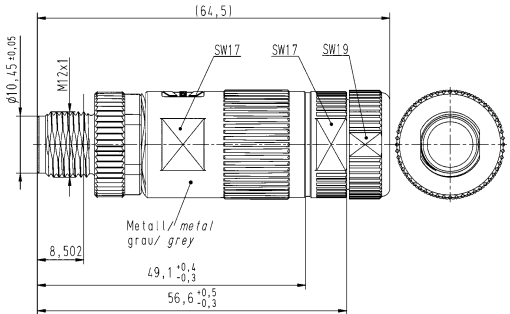
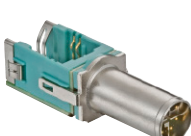
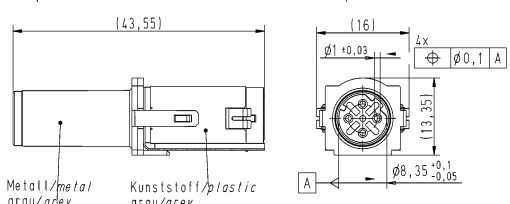
Identification	Part number	Drawing	Dimensions in mm
preLink® M12 housing 	20 82 000 1210		
preLink® M12 male module Male 8 poles, X-coding 	20 82 006 1218		
preLink® M12 connector set X-coded	20 82 005 0002		
preLink® RJ45 terminal module AWG 22/23, yellow ¹⁾ AWG 26/27, white ¹⁾ AWG 22/23, black ¹⁾ , 4 poles AWG 22/23, black ²⁾ , 4 poles	20 82 000 0001 20 82 000 0003 20 82 000 0005 20 82 000 0005 XL		
preLink® assembly tool	20 82 000 9901		



preLink® M12 cable jack
X-coded

Mating face

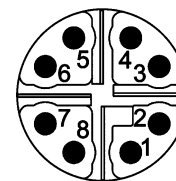

X-coding
Mating face
acc. to IEC 61076-2-109

Advantages

- M12 Ethernet-Data connector suitable for industry
- Robust design
- 360° shielding
- Category of transmission Cat. 6_A
- Suitable for solid and stranded wires
- Suitable for PoE (IEEE 802.3af) and PoE+ (IEEE 802.3at)
- Very fast **preLink®** termination technology

Technical characteristics

Connector type	M12 X-coding acc. to IEC 61076-2-109
Number of contacts	8
Transmission category	Category 6 _A , Class E _A , suitable for 1/10 Gigabit Ethernet
Transmission performance	Category 6 _A / Class E _A up to 500 MHz acc. to ISO/IEC 11801, EN 50173-1
Transmission rate	10/100 Mbit/s and 1/10 Gbit/s
Shielding	fully shielded, 360° shielding contact
Mounting	preLink® IDC termination
Cable termination for preLink® terminal module, yellow, 20 82 000 0001 and black, 20 82 000 0005 resp. 20 82 000 0005 XL	
Connectable cables	
– Conductor cross section	AWG 23 ... AWG 22 (solid and stranded)
– Conductor diameter	1.3 ... 1.6 mm
Cable termination for preLink® terminal module, white, 20 82 000 0003	
Connectable cables	
– Conductor cross section	AWG 27 ... AWG 26 (solid and stranded)
– Conductor diameter	0.8 ... 1.1 mm
Cable diameter	5.0 ... 9.5 mm
Degree of protection	IP65/IP67
Mating cycles	min. 500
Temperature range	-40 °C ... +85 °C
Housing material	Zinc die-cast, nickel-plated

Identification	Part number	Drawing	Dimensions in mm
preLink® M12 cable jack set X-coding	20 82 006 2001		
preLink® terminal module AWG 22/23, yellow ¹⁾ AWG 26/27, white ¹⁾ AWG 22/23, black ¹⁾ , 4 poles AWG 22/23, black ²⁾ , 4 poles	20 82 000 0001 20 82 000 0003 20 82 000 0005 20 82 000 0005 XL		
preLink® assembly tool	20 82 000 9901		

Further information and data sheets see www.HARTING.com

¹⁾ Packaging with 10 pieces

²⁾ Packaging with 100 pieces



Mating face

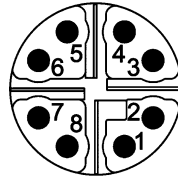

X-coding
Mating face
acc. to IEC 61076-2-109



Identification Part number Drawing Dimensions in mm

M12 Gender changer, Cat. 6A



21 03 381 6815

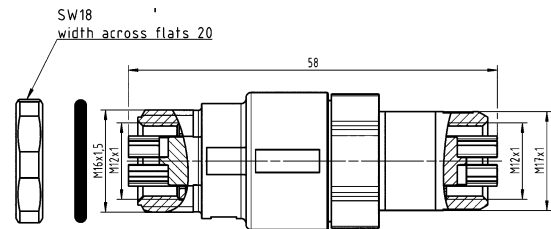

schematic diagram

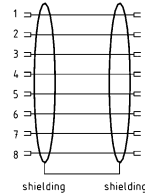

Panel cut out
(1:1)

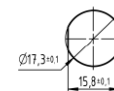

M12 Gender changer, Cat. 5
Female-Female

4 poles, D-coding
8 poles, X-coding

21 03 381 6402

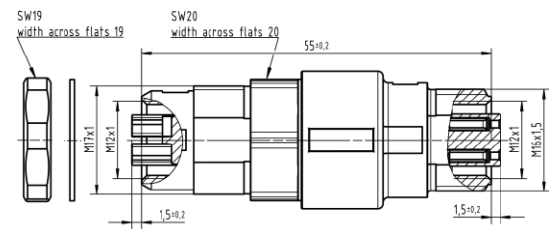

schematic diagram

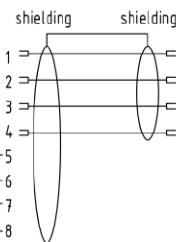

Panel cut out
(1:1)

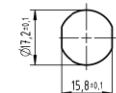

Wall bracket



21 01 000 0036

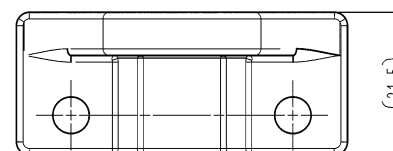
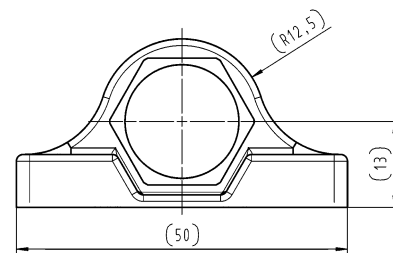

Connecting hardware



Mating face

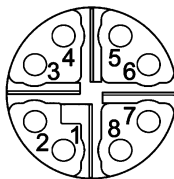

X-coding
Mating face
acc. to IEC 61076-2-109



Identification

Part number

Drawing

Dimensions in mm

har-speed M12
adapter M12-RJ45



straight, Cat. 6A

Panel thickness
min. 2.1 mm
max. 4.5 mm

21 03 381 2800

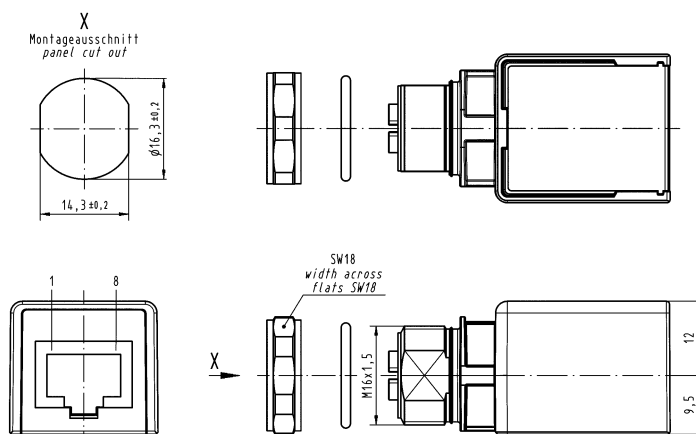





angled, Cat. 6A

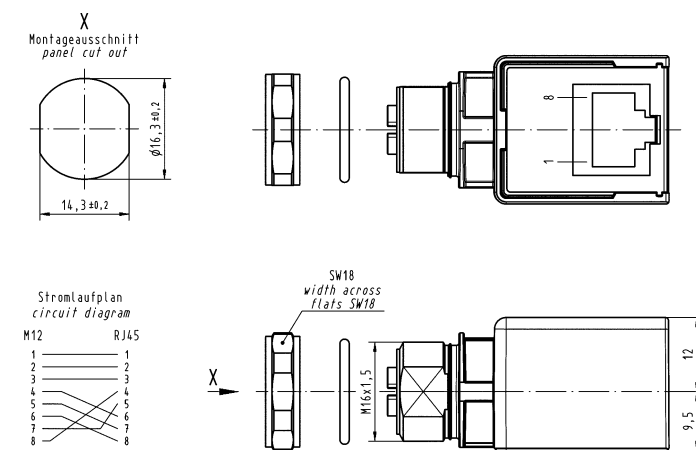



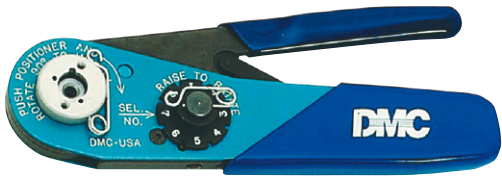

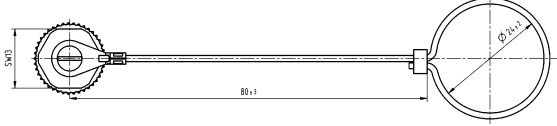

Panel thickness
min. 2.1 mm
max. 4.5 mm

21 03 381 4800

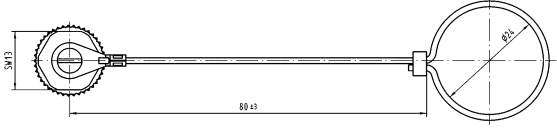

M12	RJ45
1	1
2	2
3	3
4	6
5	7
6	8
7	5
8	4

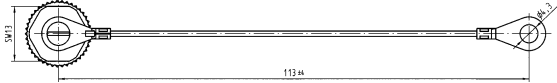
Identification	Part number	Drawing																	
<p>Crimping tool for <i>har-speed</i> M12</p>	<p>09 99 000 0501</p>																		
<p>Accessories <i>har-speed</i> M12</p> <p>Locator</p> <p>Single contacts (500 mating cycles)</p> <p><i>har-speed</i> M12 contacts AWG 28-24/0.08-0.22 mm²</p>  <p><i>har-speed</i> M12 contacts AWG 26-23/0.13-0.25 mm²</p>	<p>09 99 000 0525</p> <p>21 01 100 9014</p> <p>21 01 100 9019</p>	<p><i>har-speed</i> contacts</p>  <table border="1" data-bbox="965 728 1468 1008"> <thead> <tr> <th>Part number</th> <th>AWG</th> <th>Tool settings</th> </tr> </thead> <tbody> <tr> <td rowspan="3">21 01 100 9014</td> <td>28</td> <td>3</td> </tr> <tr> <td>26</td> <td>4</td> </tr> <tr> <td>24</td> <td>5</td> </tr> <tr> <td rowspan="3">21 01 100 9019</td> <td>26</td> <td>4</td> </tr> <tr> <td>24</td> <td>5</td> </tr> <tr> <td>23</td> <td>5</td> </tr> </tbody> </table>	Part number	AWG	Tool settings	21 01 100 9014	28	3	26	4	24	5	21 01 100 9019	26	4	24	5	23	5
Part number	AWG	Tool settings																	
21 01 100 9014	28	3																	
	26	4																	
	24	5																	
21 01 100 9019	26	4																	
	24	5																	
	23	5																	
<p>Accessories M12</p> <p>Lock nut</p>	<p>21 01 000 0018</p>																		
<p>M12 dynamometric screwdriver</p> <p>Tightening torque 0.6 Nm</p> <p>for M12 Slim design SW 15</p>	<p>09 99 000 0646</p>																		

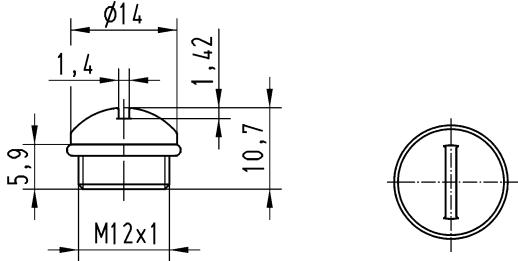
Identification	Part number	Drawing	Dimensions in mm
<p>Cap metal M12 for IP65/67 M12 metal cap for male side with cord</p> 	21 01 000 0033		
<p>Cap metal M12 for IP65/67 M12 metal cap for male side with cable clip</p> 	21 01 000 0038		
<p>Cap metal M12 for IP65/67 M12 metal cap for female side with cord</p> 	21 01 000 0030		
<p>Cap metal M12 for IP65/67 M12 metal cap for female side with cable clip</p> 	21 01 000 0031		
<p>Cap M12 for IP65/67 Seals material Viton Plastic cap for female</p> 	21 01 000 0003		

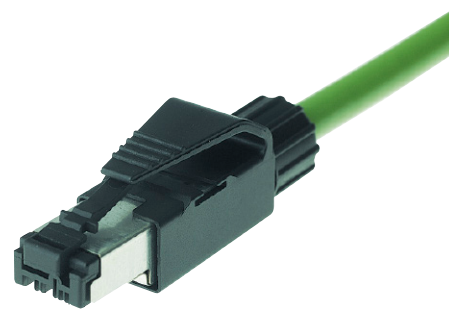

HARTING RJ Industrial® connector set RJ45, 4 poles

Advantages

- RJ45 Ethernet-Data connector suitable for industry
- Tool-less field-assembly with HARAX® rapid termination in IDC technology
- Compact design
- Ergonomical unlocking clip
- Less weight assures shock- and vibration-resisting connection
- Category of transmission Cat. 5
- Suitable for termination of solid and stranded cables
- Up to 10 x reconductable
- PROFINET compatible
- Suitable for PoE (IEEE 802.3af) and PoE+ (IEEE 802.3at)

Technical characteristics

Connector type	RJ45 connector acc. to IEC 60603-7
Number of contacts	4
Transmission performance	Category 5, Class D up to 100 MHz acc. to ISO/IEC 11801, EN 50173-1
Transmission rate	10/100 Mbit/s
Mounting	field-assembly
Cable termination	with IDC-contacts, without tools
Connectable cables	
- Conductor cross section	AWG 24/7 ... AWG 22/7 (stranded) AWG 23/1 ... AWG 22/1 (solid) AWG 26/7 (09 45 151 1109)
- Conductor diameter	max. 1.6 mm (09 45 151 1100/09 45 151 1108) max. 1.2 mm (09 45 151 1109)
- Cable diameter	6.1 ... 6.9 mm
Mating cycles	min. 750
Degree of protection	IP20
Temperature range	-40 °C ... +70 °C
Housing material	Polyamide, UL 94-V0
Colour	Black
	UL approval (E102079)

Connecting hardware

Identification	Part number	Drawing	Dimensions in mm
----------------	-------------	---------	------------------

HARTING RJ Industrial® connector set RJ45, 4 poles

incl.:
housing with shielding,
splicing element, cable gland
and instruction manual

like 09 45 151 1100
but for AWG 26

09 45 151 1100
09 45 151 1108¹⁾

09 45 151 1109

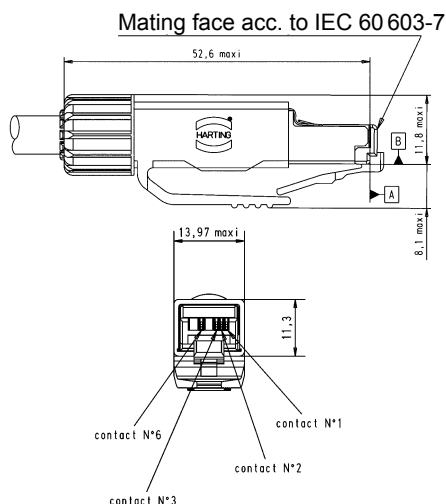

¹⁾ Packaging with 100 sets

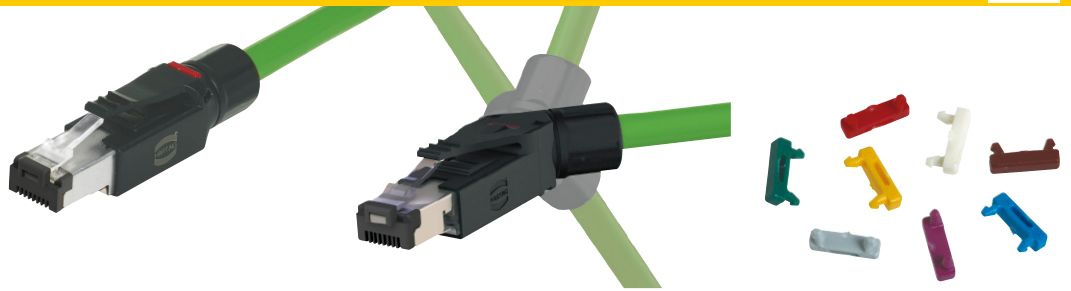

HARTING RJ Industrial® PN connector set RJ45, 4 poles

Advantages

- RJ45 Ethernet-Data connector suitable for industry
- Field-assembly with *HARAX*® quick termination in IDC technology
- Compact design
- Ergonomically unlocking clip
- Less weight assures shock- and vibration resisting connection
- Category of transmission Cat. 5e
- Suitable for solid and stranded wires
- Suitable for PoE (IEEE 802.3af) and PoE+ (IEEE 802.3at)

Technical characteristics

Connector type	RJ45 connector acc. to IEC 60603-7
Number of contacts	4
Transmission category	Category 5e, Class D, suitable for 1/10 Gigabit Ethernet
Transmission performance	Category 5e, Class D up to 100 MHz acc. to ISO/IEC 11801, EN 50 173-1
Transmission rate	10/100 Mbit/s
Shielding	fully shielded, 360° shielding contact
Mounting	Field-assembly
Cable termination	with IDC-contacts, without tools
Connectable cables	
Conductor cross section	AWG 27 ... AWG 22 (solid/stranded)
Conductor diameter	max. 1.6 mm (incl. insulation)
Cable diameter	4.5 ... 9 mm (straight version) 4.5 up to 8 mm (45° angled version)
Mating cycles	min. 750
Degree of protection	IP20
Temperature range	-40 °C ... +70 °C
Housing material	Polyamide, UL 94-V0
Colour	Black

Identification	Part number	Drawing	Dimensions in mm
HARTING RJ Industrial® PN connector set RJ45, 4 poles			
straight version	09 45 151 1120		
45° angled version (four different cable outlets possible)	09 45 151 1121		

Identification	Colour	Part number
Colour clips for colour coding the HARTING RJ Industrial® PN connector If required the colour clips can be equipped with an RFID-chip for automatic patch cable-ID recognition and storage.	White	09 45 850 0001
	Grey	09 45 850 0002
	Yellow	09 45 850 0003
	Magenta	09 45 850 0005
	Red	09 45 850 0007
	Blue	09 45 850 0008
	Green	09 45 850 0009
	Brown	09 45 850 0010



HARTING RJ Industrial® PN Compact connector set, 4 poles

Advantages

- RJ45 Ethernet-Data connector suitable for industry
- Assembly with piercing contacts
- Compact design
- Less weight assures shock- and vibration resisting connection
- Category of transmission Cat. 5
- Suitable for PoE (IEEE 802.3af) and PoE+ (IEEE 802.3at)

Technical characteristics

Connector type	RJ45 connector acc. to IEC 60603-7
Number of contacts	4
Transmission performance	Category 5, Class D up to 100 MHz acc. to ISO/IEC 11801, EN 50173-1
Transmission rate	10/100 Mbit/s
Shielding	fully shielded, 360° shielding contact
Mounting	Assembly
Cable termination	with piercing contacts
Connectable cables	
- Conductor cross section	AWG 24/7 ... AWG 22/7 (stranded)
- Conductor diameter	max. 1.6 mm (incl. insulation)
- Cable diameter	4.5 ... 7.5 mm
Mating cycles	min. 750
Degree of protection	IP20
Temperature range	-40 °C ... +70 °C
Housing material	PA, UL 94-V0
Colour	Green
	UL approval (E102079)

Connecting hardware

Identification	Part number	Drawing	Dimensions in mm
----------------	-------------	---------	------------------

HARTING RJ Industrial® PN Compact connector set, 4 poles			
Compact version	09 45 151 1130 ¹⁾		
Assembly tool	09 45 800 0530		

¹⁾ Packaging with 100 sets

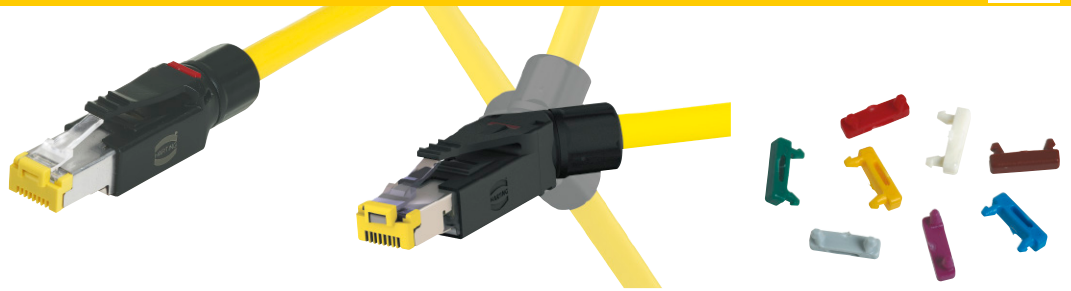

HARTING RJ Industrial® 10G connector set RJ45, 8 poles

Advantages

- RJ45 Ethernet-Data connector suitable for industry
- Field-assembly with *HARAX*® quick termination in IDC technology
- Compact design
- Ergonomically unlocking clip
- Less weight assures shock- and vibration resisting connection
- Category of transmission Cat. 6
- Suitable for solid and stranded wires
- Suitable for PoE (IEEE 802.3af) and PoE+ (IEEE 802.3at)

Technical characteristics

Connector type	RJ45 connector acc. to IEC 60603-7
Number of contacts	8
Transmission category	Category 6, Class E _A , suitable for 1/10 Gigabit Ethernet
Transmission performance	Category 6, Class E _A up to 500 MHz acc. to ISO/IEC 11801, EN 50 173-1
Transmission rate	10/100 Mbit/s and 1/10 Gbit/s
Shielding	fully shielded, 360° shielding contact
Mounting	Field-assembly
Cable termination	with IDC-contacts, without tools
Connectable cables	
Conductor cross section	AWG 27 ... AWG 22 (solid/stranded)
Conductor diameter	max. 1.6 mm (incl. insulation)
Cable diameter	4.5 ... 9 mm (straight version) 4.5 up to 8 mm (45° angled version)
Mating cycles	min. 750
Degree of protection	IP20
Temperature range	- 40 °C ... +70 °C
Housing material	Polyamide, UL 94-V0
Colour	Black

Identification	Part number	Drawing	Dimensions in mm
HARTING RJ Industrial® 10G connector set RJ45, 8 poles			
straight version	09 45 151 1560 09 45 151 1560 XL ¹⁾		
45° angled version (four different cable outlets possible)	09 45 151 1561		

Identification	Colour	Part number
Colour clips for colour coding the HARTING RJ Industrial® 10G connector If required the colour clips can be equipped with an RFID-chip for automatic patch cable-ID recognition and storage.	White	09 45 850 0001
	Grey	09 45 850 0002
	Yellow	09 45 850 0003
	Magenta	09 45 850 0005
	Red	09 45 850 0007
	Blue	09 45 850 0008
	Green	09 45 850 0009
	Brown	09 45 850 0010

¹⁾ Packaging with 100 sets

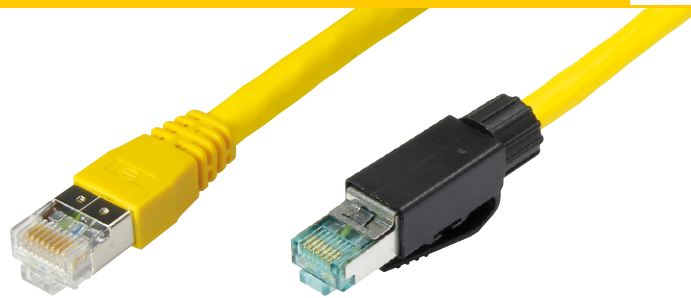

HARTING RJ Industrial® Gigalink connector set RJ45, 8 poles

Advantages

- RJ45 Ethernet-Data connector suitable for industry
- Assembly with piercing contacts
- Compact design
- Ergonomically unlocking clip
- Less weight assures shock- and vibration resisting connection
- Category of transmission Cat. 6_A
- Suitable for PoE (IEEE 802.3af) and PoE+ (IEEE 802.3at)

Technical characteristics

Connector type	RJ45 connector acc. to IEC 60603-7
Number of contacts	8
Transmission performance	Category 6 _A , Class E _A up to 500 MHz acc. to ISO/IEC 11801, EN 50173-1
Transmission rate	10/100 Mbit/s and 1/10 Gbit/s
Shielding	fully shielded, 360° shielding contact
Mounting	Assembly
Cable termination	with piercing contacts
Connectable cables	
- Conductor cross section	AWG 28/7 ... AWG 24/7 (stranded)
- Conductor diameter	max. 1.05 mm (incl. insulation)
- Cable diameter	6.1 ... 6.9 mm
Mating cycles	min. 750
Degree of protection	IP20
Temperature range	-40 °C ... +70 °C
Housing material	polycarbonate, UL 94-V0
Colour	Black, yellow
	UL approval (E102079)

Connecting hardware

Identification	Part number	Drawing	Dimensions in mm
<p>HARTING RJ Industrial® Gigalink Cat. 6_A connector set RJ45, 8 poles</p> <p>incl.: housing with shielding, cable gland and instruction manual</p>	<p>09 45 151 1520</p> <p>09 45 151 1520 XL¹⁾</p>		
<p>Assembly tool for 09 45 151 1520</p>	<p>09 45 800 0520</p>		
<p>Compact version</p>	<p>09 45 151 1525¹⁾</p>		
<p>Assembly tool for 09 45 151 1525</p>	<p>09 45 800 0025</p>		

¹⁾ Packaging with 100 sets



HARTING RJ Industrial® Gigalink connector set RJ45, 8 poles

Advantages

- RJ45 Ethernet-Data connector suitable for industry
- Assembly with piercing contacts
- Compact design
- Ergonomically unlocking clip
- Less weight assures shock- and vibration resisting connection
- Category of transmission Cat. 6_A
- Suitable for PoE (IEEE 802.3af) and PoE+ (IEEE 802.3at)

Technical characteristics

Connector type	RJ45 connector acc. to IEC 60603-7
Number of contacts	8
Transmission performance	Category 6 _A , Class E _A up to 500 MHz acc. to ISO/IEC 11801, EN 50173-1
Transmission rate	10/100 Mbit/s and 1/10 Gbit/s
Shielding	fully shielded, 360° shielding contact
Mounting	Assembly
Cable termination	with piercing contacts
Connectable cables	
- Conductor cross section	AWG 28/7 ... AWG 24/7 (stranded)
- Conductor diameter	max. 1.05 mm (incl. insulation)
- Cable diameter	5.0 ... 6.5 mm
Mating cycles	min. 750
Degree of protection	IP20
Temperature range	-40 °C ... +70 °C
Housing material	polycarbonate, UL 94-V0
Colour	Black
	UL approval (E102079)

Identification	Part number	Drawing	Dimensions in mm
HARTING RJ Industrial® Gigalink Cat. 6 _A Compact connector set RJ45, 8 poles without cable grommet	09 45 151 1524 ¹⁾		
Suitable assembly tool	09 45 800 0025		
Cable grommet			
yellow	09 45 151 0010 ¹⁾		
green	09 45 151 0021 ¹⁾		
black	09 45 151 0022 ¹⁾		
light grey	09 45 151 0023 ¹⁾		
red	09 45 151 0024 ¹⁾		
white	09 45 151 0025 ¹⁾		
blue	09 45 151 0026 ¹⁾		

¹⁾ Packaging with 100 sets

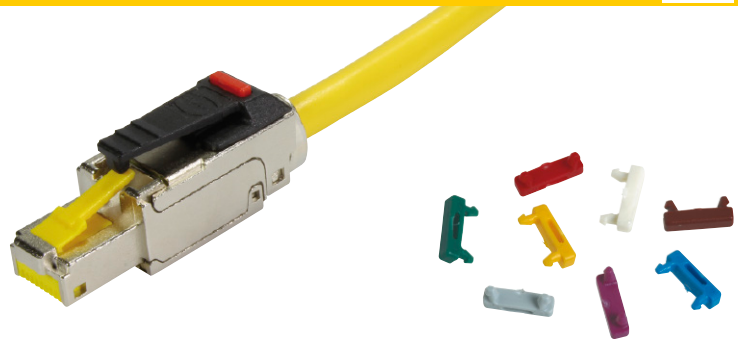

preLink® RJ45 connector

Advantages

- RJ45 Ethernet-Data connector suitable for industry
- Compact and robust design
- 360° shielding
- Ergonomically unlocking clip
- C< of transmission Cat. 6A
- Suitable for solid and stranded wires
- Suitable for PoE (IEEE 802.3af) and PoE+ (IEEE 802.3at)

Technical characteristics

Connector type	RJ45 connector acc. to IEC 60603-7
Number of contacts	8
Transmission category	Category 6A, Class EA, suitable for 1/10 Gigabit Ethernet
Transmission performance	Category 6A, Class EA up to 500 MHz acc. to ISO/IEC 11801, EN 50173-1
Transmission rate	10/100 Mbit/s and 1/10 Gbit/s
Shielding	fully shielded, 360° shielding contact
Mounting	preLink® IDC termination
Cable termination for preLink® terminal module, yellow, 20 82 000 0001	
Connectable cables	
– Conductor cross section	AWG 23 ... AWG 22 (solid and stranded)
– Conductor diameter	1.3 ... 1.6 mm
Cable termination for preLink® terminal module, white, 20 82 000 0003	
Connectable cables	
– Conductor cross section	AWG 27 ... AWG 26 (solid and stranded)
– Conductor diameter	0.8 ... 1.1 mm
Cable diameter	5 ... 9 mm
Degree of protection	IP20
Mating cycles	min. 750
Temperature range	–40 °C ... +70 °C
Housing material	Zinc die-cast, nickel-plated

Connecting hardware

Identification	Part number	Drawing	Dimensions in mm
preLink® RJ45 connector	20 82 101 0010		
preLink® RJ45 terminal module	20 82 000 0001		
AWG 26/27, white ¹⁾	20 82 000 0003		
AWG 22/23, black ¹⁾ , 4 poles	20 82 000 0005		
AWG 22/23, black ²⁾ , 4 poles	20 82 000 0005 XL		
preLink® assembly tool	20 82 000 9901		

Identification	Colour	Part number
Colour clips for colour coding the preLink® connectors	White	09 45 850 0001
	Grey	09 45 850 0002
	Yellow	09 45 850 0003
	Magenta	09 45 850 0005
	Red	09 45 850 0007
	Blue	09 45 850 0008
	Green	09 45 850 0009
	Brown	09 45 850 0010

¹⁾ Packaging with 10 pieces
²⁾ Packaging with 100 pieces

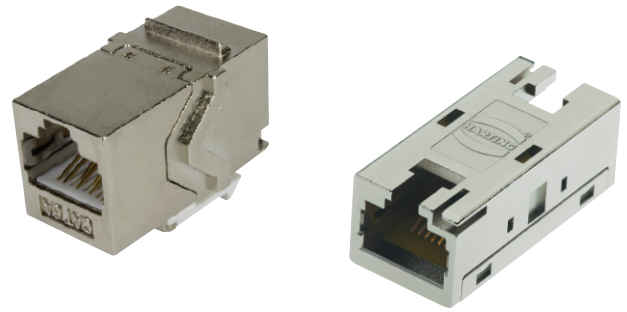

HARTING RJ Industrial® 10G RJ45 bulkhead

Advantages

- Compact and robust design
- 360° shielding
- Compatible with HIFF dimensions for use in:
 - Han® 3 A series
 - HARTING PushPull (V4)
 - Han® PushPull (V14)
 - *har*-port
- Suitable for PoE (IEEE 802.3af) and PoE+ (IEEE 802.3at)

Technical characteristics

Mating face	RJ45 acc. to IEC 60603-7
Number of contacts	8
Transmission category	Cat. 6, performance Class EA, suitable for 1/10 Gigabit Ethernet
Degree of protection	IP20
Mating cycles	min. 750
Temperature range	–40 °C ... +70 °C
Housing material	Zinc die-cast, nickel-plated
Flammability acc. to UL 94	V0

Identification	Part number	Drawing	Dimensions in mm
----------------	-------------	---------	------------------

HARTING RJ Industrial® 10G RJ45 bulkhead (HIFF version)

09 45 545 1560

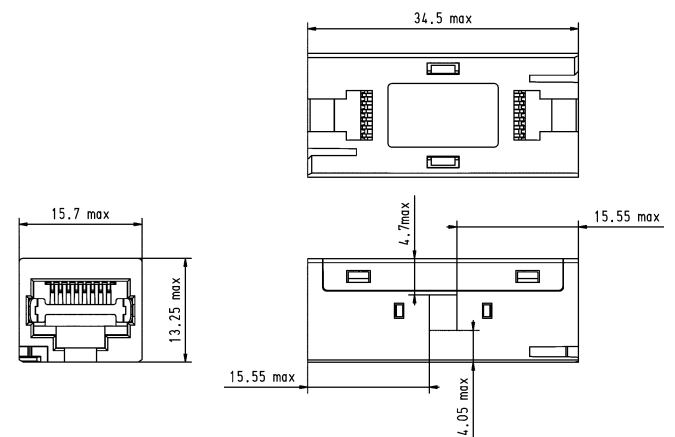

HARTING RJ Industrial® 10G RJ45 bulkhead (keystone version)

09 45 545 1568

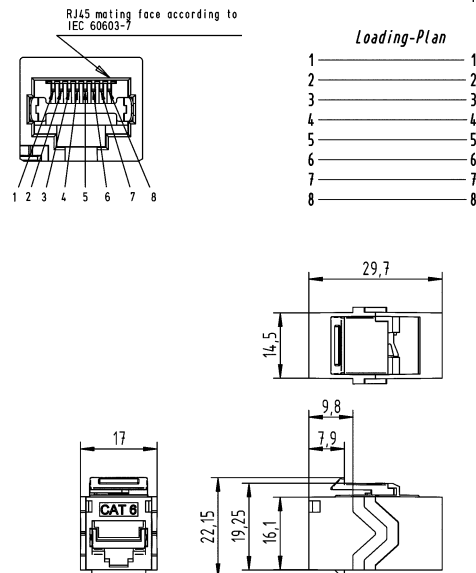

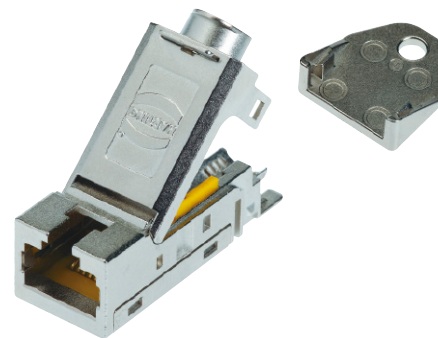

HARTING RJ Industrial® cable jack (HIFF version)

Advantages

- Compact and robust design
- 360° shielding
- Category of transmission Cat. 6
- Suitable for solid and stranded wires
- Field-assembly with quick termination in IDC technology
- Compatible with HIFF dimensions for use in:
 - Han® 3 A series with HIFF adapter 09 45 515 0024
 - HARTING PushPull (V4)
 - Compact bulkhead mounting housing 09 45 545 0028
 - EasyInstall bulkhead mounting housing 09 45 545 0032
 - Han® PushPull (V14)
 - Panel feed-through plastic 09 35 012 0331
 - Panel feed-through metal rectangular 09 35 012 0311
 - Panel feed-through metal circular 09 35 012 0312
 - har-port 09 45 452 0000
- Suitable for PoE (IEEE 802.3af) and PoE+ (IEEE 802.3at)

Technical characteristics

Connector type	RJ45 connector acc. to IEC 60603-7
Number of contacts	8
Transmission category	Category 6, Class E _A , suitable for 1/10 Gigabit Ethernet
Transmission performance	Category 6, Class E _A up to 500 MHz acc. to ISO/IEC 11801, EN 50173-1
Transmission rate	10/100 Mbit/s and 1/10 Gbit/s
Shielding	fully shielded, 360° shielding contact
Mounting	Field-assembly
Cable termination	with IDC-contacts, without tools
Connectable cables	
- Conductor cross section	AWG 27 ... AWG 24 (solid/stranded) ¹⁾
- Conductor diameter	AWG 24 ... AWG 22 (solid/stranded) ²⁾
- Cable diameter	max. 1.6 mm (incl. insulation)
- Cable diameter	5 ... 9 mm
Mating cycles	min. 750
Degree of protection	IP20
Temperature range	-40 °C ... +70 °C
Housing material	Zinc die-cast, nickel-plated

Identification	Part number	Drawing	Dimensions in mm
HARTING RJ Industrial® 10G cable jack, 8 poles			
AWG 28 ... 24	09 45 545 1561		
AWG 24 ... 22	09 45 545 1562		
HARTING RJ Industrial® PN cable jack, 4 poles, Cat. 5			
AWG 24 ... 22	09 45 545 1120		
Unlocking tool for opening of the HARTING RJ Industrial® cable jacks	20 82 000 9916		

¹⁾ For part number 09 45 545 1561

²⁾ For part number 09 45 545 1562 and 09 45 545 1120



preLink® RJ45 jacks (HIFF)

Advantages

- Compact and robust design
- Category of transmission Cat. 6
- Suitable for solid and stranded wires
- Compatible with HIFF dimensions for use in:
 - Han® 3 A series with HIFF adapter 09 45 515 0024
 - HARTING PushPull (V4)
 - Compact bulkhead mounting housing 09 45 545 0028
 - EasyInstall bulkhead mounting housing 09 45 545 0032
 - Han® PushPull (V14)
 - Panel feed-through plastic 09 35 012 0331
 - Panel feed-through metal rectangular 09 35 012 0311
 - Panel feed-through metal circular 09 35 012 0312
 - har-port 09 45 452 0000
- Suitable for PoE (IEEE 802.3af) and PoE+ (IEEE 802.3at)

Technical characteristics

Connector type	RJ45 connector acc. to IEC 60603-7
Number of contacts	8
Transmission category	Category 6 _A , Class E _A , suitable for 1/10 Gigabit Ethernet
Transmission performance	Category 6 _A , Class E _A up to 500 MHz acc. to ISO/IEC 11801, EN 50 173-1
Transmission rate	10/100 Mbit/s and 1/10 Gbit/s
Shielding	fully shielded, 360° shielding contact
Mounting	preLink® IDC termination
Cable termination for preLink® terminal module, yellow, 20 82 000 0001	
Connectable cables	
– Conductor cross section	AWG 23 ... AWG 22 (solid and stranded)
– Conductor diameter	1.3 ... 1.6 mm
Cable termination for preLink® terminal module, white, 20 82 000 0003	
Connectable cables	
– Conductor cross section	AWG 27 ... AWG 26 (solid and stranded)
– Conductor diameter	0.8 ... 1.1 mm
Cable diameter	5 ... 9 mm
Degree of protection	IP20
Mating cycles	min. 750
Temperature range	–40 °C ... +70 °C
Housing material	Zinc die-cast, nickel-plated

Identification	Part number	Drawing	Dimensions in mm
preLink® set RJ45 jack consists of: • 1x RJ45 module • 1x terminal module • 1x cable tie	AWG 22/23 20 82 001 0001 AWG 26/27 20 82 001 0002		
preLink® RJ45 jack module	20 82 000 0002		
preLink® RJ45 terminal module	AWG 22/23, yellow ¹⁾ 20 82 000 0001 AWG 26/27, white ¹⁾ 20 82 000 0003 AWG 22/23, black ¹⁾ , 4 poles 20 82 000 0005 AWG 22/23, black ²⁾ , 4 poles 20 82 000 0005 XL		
preLink® assembly tool	20 82 000 9901		

¹⁾ Packaging with 10 pieces
²⁾ Packaging with 100 pieces



preLink®
19" patch panel, HIFF

Advantages

- Flexible, suitable for preLink® modules RJ45 jack and HARTING RJ Industrial® modules in HIFF size
- Economical, time-saving installation due to the slidable module carrier, frontward and backward removal
- Safety, additional strain-relief
- Fully shielded modules connected by module carrier
- Earth bolt
- IP20 installation for distributors and switch cabinets

Technical characteristics

Number of modules	24
Transmission performance	Category 6, Class E _A up to 500 MHz acc. to ISO/IEC 11801, EN 50 173-1
Transmission rate	up to 10 Gbit/s
Assembly	in 19" racks acc. to IEC/DIN EN 60297-3-100 (DIN 41 494-1)
Dimensions (W x H x D)	482.6 mm (19") x 44.5 mm (1 U) x 181 mm
Degree of protection	IP20
Operating temperature range	-40 °C ... +70 °C
Material	
module carrier, 2-parts	steel sheet
front cover	stainless steel

Identification	Part number	Drawing	Dimensions in mm
----------------	-------------	---------	------------------

preLink®
19" patch panel, unloaded

Suitable modules:

- preLink® RJ45 jack, HIFF
- mixed loading possible

Range of delivery::

- Screw set M5
- 24 cable ties
- 1x earth conductor 6 mm²

20 82 400 0001

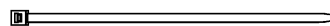
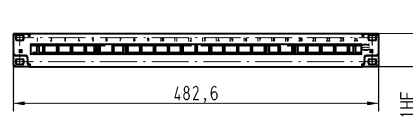
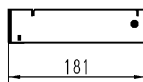

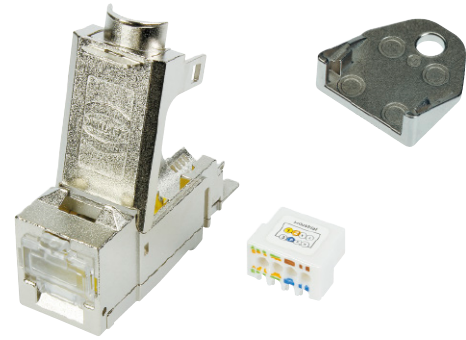

HARTING RJ Industrial® cable jack (keystone version)

Advantages

- Compact and robust design
- 360° shielding
- Category of transmission Cat. 6_A
- Suitable for solid and stranded wires
- Field-assembly with quick termination in IDC technology
- Keystone form factor – useable for DIN-rail outlet 09 45 851 0000 and a wide range of typical patch panels and wall outlets
- Suitable for PoE (IEEE 802.3af) and PoE+ (IEEE 802.3at)

Technical characteristics

Connector type	RJ45 connector acc. to IEC 60603-7
Number of contacts	8
Transmission category	Category 6 _A , Class E _A , suitable for 1/10 Gigabit Ethernet
Transmission performance	Category 6 _A , Class E _A up to 500 MHz acc. to ISO/IEC 11801, EN 50 173-1
Transmission rate	10/100 Mbit/s and 1/10 Gbit/s
Shielding	fully shielded, 360° shielding contact
Mounting	Field-assembly
Cable termination	with IDC-contacts, without tools
Connectable cables	
- Conductor cross section	AWG 27 ... AWG 24 (solid/stranded) ¹⁾
- Conductor diameter	AWG 24 ... AWG 22 (solid/stranded) ²⁾
- Cable diameter	max. 1.6 mm (incl. insulation) ¹⁾ max. 1.2 mm (incl. insulation) ²⁾ 5 ... 9 mm
Mating cycles	min. 750
Degree of protection	IP20
Temperature range	-40 °C ... +70 °C
Housing material	Zinc die-cast, nickel-plated

Identification	Part number	Drawing	Dimensions in mm
HARTING RJ Industrial® 10G cable jack, 8 poles			
AWG 28 ... 24	09 45 545 1563		
AWG 24 ... 22	09 45 545 1564		
HARTING RJ Industrial® PN cable jack, 4 poles, Cat. 5			
AWG 24 ... 22	09 45 545 1122		
Unlocking tool for opening of the HARTING RJ Industrial® cable jacks	20 82 000 9916		

¹⁾ For part number 09 45 545 1564

²⁾ For part number 09 45 545 1563 and 09 45 545 1122



preLink® RJ45 jack
(keystone version)

Advantages

- RJ45 Ethernet-Data jack suitable for industry
- Compact and robust design
- 360° shielding
- Ergonomically unlocking clip
- Category of transmission Cat. 6_A
- Suitable for solid and stranded wires
- Compatible with keystone panel cut out acc. to IEC 60603-7
- Suitable for PoE (IEEE 802.3af) and PoE+ (IEEE 802.3at)

Technical characteristics

Connector type	RJ45 connector acc. to IEC 60603-7
Number of contacts	8
Transmission category	Category 6 _A , Class E _A , suitable for 1/10 Gigabit Ethernet
Transmission performance	Category 6 _A , Class E _A up to 500 MHz acc. to ISO/IEC 11801, EN 50 173-1
Transmission rate	10/100 Mbit/s and 1/10 Gbit/s
Shielding	fully shielded, 360° shielding contact
Mounting	preLink® IDC termination
Cable termination for preLink® terminal module, yellow, 20 82 000 0001	
Connectable cables	
– Conductor cross section	AWG 23 ... AWG 22 (solid and stranded)
– Conductor diameter	1.3 ... 1.6 mm
Cable termination for preLink® terminal module, white, 20 82 000 0003	
Connectable cables	
– Conductor cross section	AWG 27 ... AWG 26 (solid and stranded)
– Conductor diameter	0.8 ... 1.1 mm
Cable diameter	5 ... 9 mm
Degree of protection	IP20
Mating cycles	min. 750
Temperature range	–40 °C ... +70 °C
Housing material	Zinc die-cast, nickel-plated

Connecting hardware

Identification	Part number	Drawing	Dimensions in mm
----------------	-------------	---------	------------------

preLink® set
RJ45 keystone jack
consists of:

- 1x RJ45 module
- 1x terminal module
- 1x cable tie

AWG 22/23

20 82 501 0001

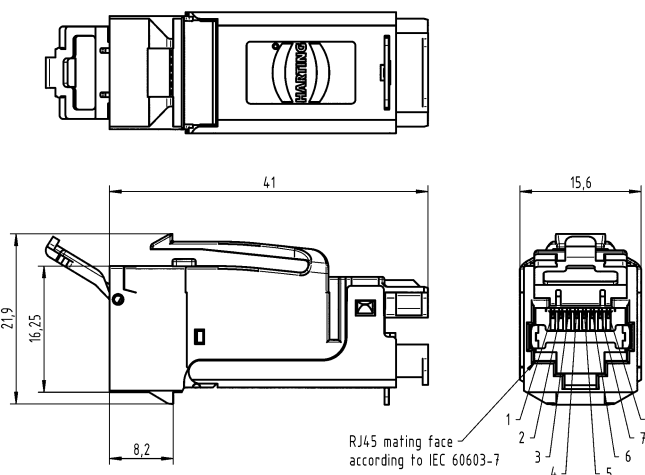

preLink® RJ45
keystone jack module

20 82 500 0001

preLink® RJ45 angled
keystone jack module

20 82 500 0002¹⁾

preLink® RJ45 terminal module

- AWG 22/23, yellow²⁾
- AWG 26/27, white²⁾
- AWG 22/23, black²⁾, 4 poles
- AWG 22/23, black³⁾, 4 poles

20 82 000 0001
20 82 000 0003
20 82 000 0005
20 82 000 0005 XL

preLink® assembly tool

20 82 000 9901

1) Packaging with 24 pieces
2) Packaging with 10 pieces
3) Packaging with 100 pieces



preLink®
19" patch panel, Keystone

Advantages

- Suitable for preLink® RJ45 module in Keystone size
- Economic due to easy design
- Safety, additional strain-relief
- Fully shielded modules connected through metal holding fixture
- Earth bolt

Technical characteristics

Number of modules	24
Transmission performance	Category 6, Class E _A up to 500 MHz acc. to ISO/IEC 11801, EN 50 173-1
Transmission rate	up to 10 Gbit/s
Module design	Keystone size acc. to EN 60 603-7:2009
Assembly	in 19" racks acc. to IEC/DIN EN 60 297-3-100 (DIN 41 494-1)
Dimensions (W x H x D)	482.6 mm (19") x 44.5 mm (1 U) x 107 mm
Degree of protection	IP20
Operating temperature range	-40 °C ... +70 °C
Material	steel sheet

Identification	Part number	Drawing	Dimensions in mm
----------------	-------------	---------	------------------

preLink®
19" patch panel, Keystone

20 82 405 0001

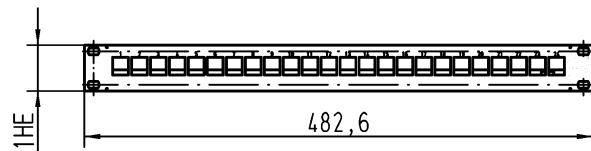

Range of delivery::

24 pieces of:

- preLink® RJ45 Keystone jack
- terminal modules for AWG 22/23
- strain relief

preLink®
19" patch panel, Keystone
empty

20 82 400 0002

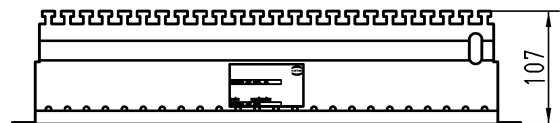



HARTING Cabinet Outlet RJ45, 8 poles
RJ45 distribution module for IP20 environments
(top-hat rail mounting)

Advantages

- Simple mounting
- Dust protection caps
- Port identification
- Angled output

Technical characteristics

Number of ports, Copper/Termination	1/RJ45 (Twisted Pair)
Transmission performance	Category 6A, Class E _A up to 250 MHz acc. to ISO/IEC 11801, EN 50 173-1
Transmission rate	10/100 Mbit/s and 1/10 Gbit/s
Mounting	To 35 mm top-hat mounting rail acc. to DIN EN 60715, alignable
Dimensions (H x W x D)	71 x 18 x 68 mm
Degree of protection	IP20
Operating temperature range	-20 °C ... +70 °C
Housing material	Polyamide, UL94 V-0
Colour	Grey

Identification	Part number	Drawing	Dimensions in mm
HARTING RJ Industrial® Cabinet Outlet RJ45	09 45 851 0000		
Protection cover set for 09 45 851 0000	09 45 851 0001		
Usable RJ45 cable jacks			
• preLink® keystone set AWG 22/23 (with preLink® terminal block)	20 82 501 0001		
• preLink® keystone set (without preLink® terminal block)	20 82 500 0001		
Usable with preLink® terminal blocks			
• preLink® terminal block AWG 22/23 (24)	20 82 000 0001		
• preLink® terminal block AWG 26/27	20 82 000 0003		
Usable RJ45 cable jacks			
• RJ45 keystone module IDC AWG 24 – AWG 22	09 45 545 1564		
• RJ45 keystone module IDC AWG 27 – AWG 26	09 45 545 1563		

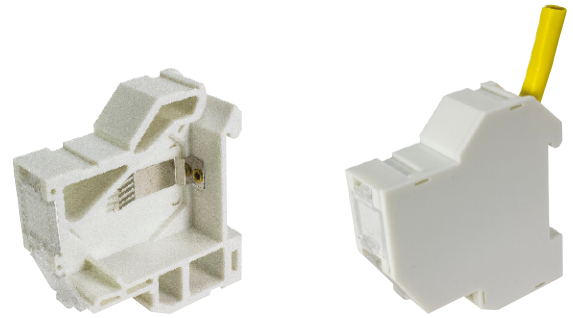

HARTING Cabinet Outlet RJ45, 8 poles
 RJ45 distribution module for IP20 environments
 (top-hat rail mounting)

Advantages

- Simple mounting
- Dust protection caps
- Port identification
- Angled output

Technical characteristics

Number of ports, Copper / Termination	1 / RJ45 (Twisted Pair)
Transmission performance	Category 6 _A / Class E _A up to 250 MHz acc. to ISO/IEC 11801, EN 50 173-1
Transmission rate	10/100 Mbit/s and 1/10 Gbit/s
Mounting	To 35 mm top-hat mounting rail acc. to DIN EN 60 715, alignable
Dimensions (H x W x D)	70 x 18 x 70 mm, compatible for DIN 43880 distribution boxes
Degree of protection	IP20
Operating temperature range	-20 °C ... +70 °C
Housing material	Polyamide, UL94 V-0
Colour	Grey

Identification	Part number	Drawing	Dimensions in mm
HARTING RJ Industrial® Cabinet Outlet RJ45	09 45 851 0002		
Lateral cover for 09 45 851 0002	09 45 851 0003		
Usable RJ45 cable jacks			
• preLink® keystone set AWG 22/23 (with preLink® terminal block)	20 82 501 0001		
• preLink® keystone set (without preLink® terminal block)	20 82 500 0001		
Usable with preLink® terminal blocks			
• AWG 22/23, yellow ¹⁾	20 82 000 0001		
• AWG 26/27, white ¹⁾	20 82 000 0003		
• AWG 22/23, black ¹⁾ , 4 poles	20 82 000 0005		
• AWG 22/23, black ²⁾ , 4 poles	20 82 000 0005 XL		
Usable RJ45 cable jacks			
• RJ45 keystone module IDC AWG 24 – AWG 22	09 45 545 1564		
• RJ45 keystone module IDC AWG 27 – AWG 26	09 45 545 1563		

¹⁾ Packaging with 10 pieces

²⁾ Packaging with 100 pieces

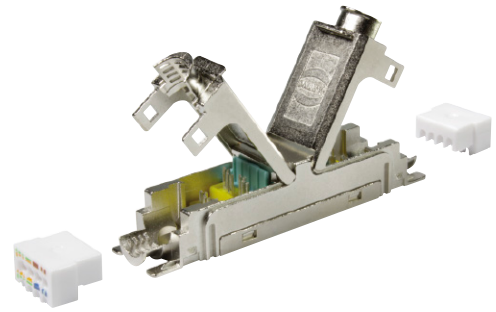

HARTING RJ Industrial® 10G Extender

Advantages

- Simple, fast and reliable connection of data cables
- Compact and robust design
- 360° shielding
- Category of transmission Cat. 6_A
- Suitable for solid and stranded wires
- Field assembly without special tools

Technical characteristics

Connector type	RJ45 connector acc. to IEC 60603-7
Number of contacts	8
Transmission category	Category 6 _A , Class E _A , suitable for 1/10 Gigabit Ethernet
Transmission performance	Category 6 _A , Class E _A up to 500 MHz acc. to ISO/IEC 11801, EN 50173-1
Transmission rate	10/100 Mbit/s and 1/10 Gbit/s
Shielding	fully shielded, 360° shielding contact
Mounting	preLink® IDC termination
Connectable cables	
– Conductor cross section	AWG 23 ... AWG 22 (solid and stranded)
– Conductor diameter	1.3 ... 1.6 mm
Cable diameter	5 ... 9 mm
Degree of protection	IP20
Temperature range	-40 °C ... +70 °C
Housing material	Zinc die-cast, nickel-plated

Application

- Extension of cables for data communication
- Connection of cables with different cross-sections
- Linking of fire compartments

Identification	Part number	Drawing	Dimensions in mm
----------------	-------------	---------	------------------

HARTING RJ Industrial®
10G Extender

09 45 545 1569

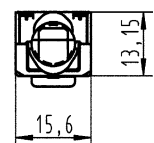
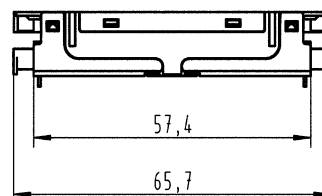

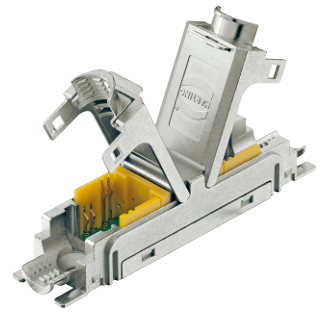

preLink® Extender

Advantages

- Simple, fast and reliable connection of data cables
- Compact and robust design
- 360° shielding
- Category of transmission Cat. 6A
- Suitable for solid and stranded wires

Technical characteristics

Connector type	RJ45 connector acc. to IEC 60603-7
Number of contacts	8
Transmission category	Category 6A, Class EA, suitable for 1/10 Gigabit Ethernet
Transmission performance	Category 6A, Class EA up to 500 MHz acc. to ISO/IEC 11801, EN 50 173-1
Transmission rate	10/100 Mbit/s and 1/10 Gbit/s
Shielding	fully shielded, 360° shielding contact
Mounting	preLink® IDC termination
Cable termination for preLink® terminal module, yellow, 20 82 000 0001	
Connectable cables	
– Conductor cross section	AWG 23 ... AWG 22 (solid and stranded)
– Conductor diameter	1.3 ... 1.6 mm
Cable termination for preLink® terminal module, white, 20 82 000 0003	
Connectable cables	
– Conductor cross section	AWG 27 ... AWG 26 (solid and stranded)
– Conductor diameter	0.8 ... 1.1 mm
Cable diameter	5 ... 9 mm
Degree of protection	IP20
Mating cycles	min. 750
Temperature range	–40 °C ... +70 °C
Housing material	Zinc die-cast, nickel-plated

Application

- Extension of cables for data communication
- Connection of cables with different cross-sections
- Linking of fire compartments

Identification	Part number	Drawing	Dimensions in mm
preLink® Extender	20 82 101 0001		
preLink® RJ45 terminal module			
AWG 22/23, yellow ¹⁾	20 82 000 0001		
AWG 26/27, white ¹⁾	20 82 000 0003		
AWG 22/23, black ¹⁾ , 4 poles	20 82 000 0005		
AWG 22/23, black ²⁾ , 4 poles	20 82 000 0005 XL		
preLink® assembly tool	20 82 000 9901		

¹⁾ Packaging with 10 pieces

²⁾ Packaging with 100 pieces



preLink® PCB jack

Advantages

- Easy device integration
- Robust design
- 360° shielding
- Suitable for wave and reflow soldering (PSL RO and MSL 1)
- Suitable for solid and stranded wires
- Suitable for PoE (IEEE 802.3af) and PoE+ (IEEE 802.3at)
- Very fast **preLink®** termination technology

Technical characteristics

Connector type	PCB jack 8 poles THR
Number of contacts	8
Shielding	fully shielded, 360° shielding contact
Mounting	preLink® IDC termination
Cable termination for preLink® terminal module, yellow, 20 82 000 0001 and black, 20 82 000 0005 resp. 20 82 000 0005 XL	
Connectable cables	
– Conductor cross section	AWG 23 ... AWG 22 (solid and stranded)
– Conductor diameter	1.3 ... 1.6 mm
Cable termination for preLink® terminal module, white, 20 82 000 0003	
Connectable cables	
– Conductor cross section	AWG 27 ... AWG 26 (solid and stranded)
– Conductor diameter	0.8 ... 1.1 mm
Cable diameter	5.0 ... 9.5 mm
Degree of protection	IP20
Mating cycles	min. 10
Temperature range	-40 °C ... +85 °C

Identification	Part number	Drawing	Dimensions in mm
preLink® PCB jack	20 82 007 1100		
preLink® terminal module AWG 22/23, yellow ¹⁾ AWG 26/27, white ¹⁾ AWG 22/23, black ¹⁾ , 4 poles AWG 22/23, black ²⁾ , 4 poles	20 82 000 0001 20 82 000 0003 20 82 000 0005 20 82 000 0005 XL		
preLink® assembly tool	20 82 000 9901		

Further information and data sheets see www.HARTING.com

¹⁾ Packaging with 10 pieces

²⁾ Packaging with 100 pieces

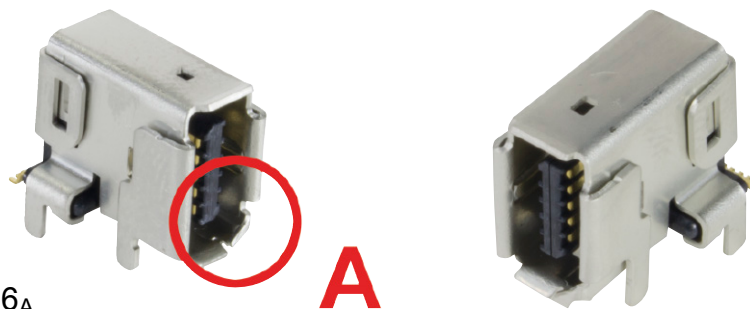

HARTING ix Industrial® jack type A, Cat. 6_A

Advantages

- Ethernet-Data jack suitable for industry
- Compact and robust design
- 360° shielding
- Category of transmission Cat. 6_A
- 5000 mating cycles
- 70 % reduced size compared to RJ45

Technical characteristics

Connector type	HARTING ix Industrial® jack type A, angled acc. to IEC 61076-3-124
Number of contacts	10 (8 data + 2 GND)
Transmission performance	Category 6 _A / Class E _A up to 500 MHz acc. to ISO/IEC 11801, EN 50173-1
Transmission rate	10/100 Mbit/s and 1/10 Gbit/s
Shielding	fully shielded, 360° shielding contact
Rated current	1.5 A
Rated voltage	50 V
Contact resistance	≤ 30 mΩ
Insertion and withdrawal force	≤ 25 N
Test voltage U _{r.m.s.}	500 V
Flammability	UL 94 V-0
Degree of protection	IP20
Mating cycles	min. 5000
Temperature range	-40 °C ... +80 °C
Material insert	LCP, black

Identification

HARTING ix Industrial® jack type A, angled

Delivery range:

- 1 piece
- 400 pieces on reel

Part number

09 45 281 2560 333
09 45 281 2560

Drawing

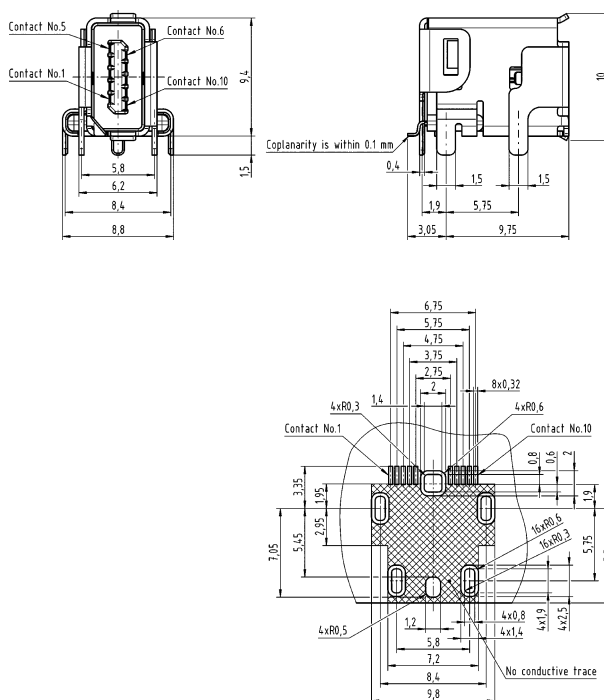

Dimensions in mm



HARTING ix Industrial® connector type A, Cat. 6A

Advantages

- Ethernet-Data jack suitable for industry
- Compact and robust design
- 360° shielding
- Category of transmission Cat. 6A
- 5000 mating cycles
- 70 % reduced size compared to RJ45

Technical characteristics

Connector type	HARTING ix Industrial® connector type A, angled, acc. to IEC 61 076-3-124
Number of contacts	10 (8 data + 2 GND)
Transmission performance	Category 6A / Class E _A up to 500 MHz acc. to ISO/IEC 11 801, EN 50 173-1
Transmission rate	10/100 Mbit/s and 1/10 Gbit/s
Shielding	fully shielded, 360° shielding contact
Rated current	1.5 A
Rated voltage	50 V
Contact resistance	≤ 30 mΩ
Insertion and withdrawal force	≤ 25 N
Test voltage U _{r.m.s.}	500 V
Flammability	UL 94 V-0
Degree of protection	IP20
Mating cycles	min. 5000
Temperature range	-40 °C ... +80 °C
Material insert	LCP, black
Cable diameter	6.3 ... 7.2 mm

Connecting hardware

Identification	Part number	Drawing	Dimensions in mm
----------------	-------------	---------	------------------

HARTING ix Industrial® type A connector







with solder termination for AWG 28/7 - 22/7 and conductor diameters up to 1.55 mm

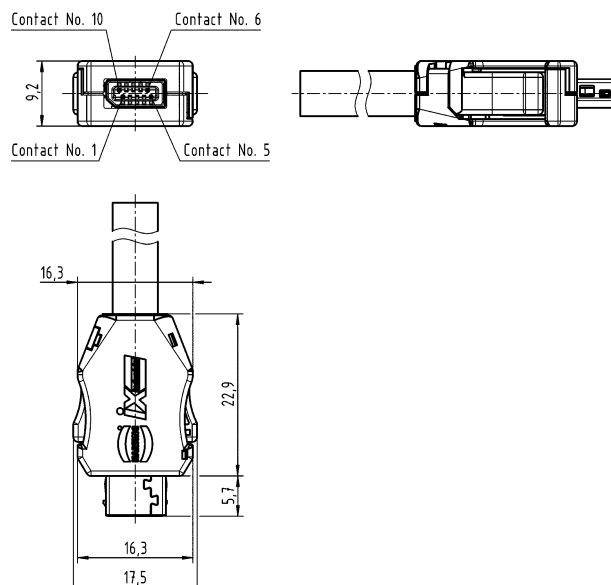

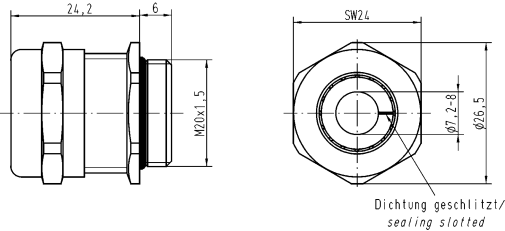

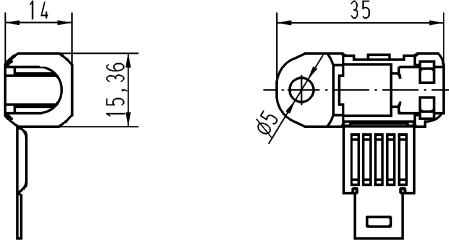
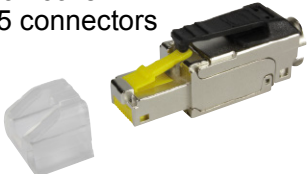

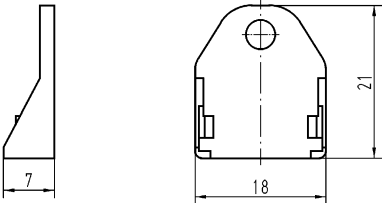
09 45 181 2560 XL

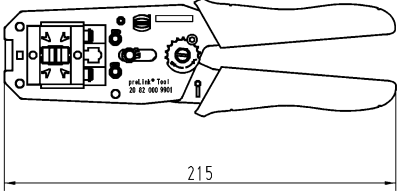
with IDC termination for AWG 28/7 - 26/7 and conductor diameters from 0.95 - 1.05 mm

09 45 181 2561 XL



Identification	Part number	Drawing	Dimensions in mm
<p>Cable gland M20x1.5 for pre-terminated preLink® cable assemblies</p> <p>with slotted seal</p> <p>Cable-sheath 7.2 mm ... 8.0 mm</p> <p>Cable-sheath 4.0 mm ... 6.5 mm</p> 	<p>19 00 000 5020</p> <p>19 00 000 5079</p>		
<p>Protection cover for pre-terminated preLink® cable assemblies</p> <p>Set of 10 pieces</p> 	<p>20 82 000 9915</p>		
<p>Protection cover for RJ45 connectors</p> 	<p>09 45 852 0000</p>		
<p>Protection cover for RJ45 jacks</p> 	<p>09 45 852 0001</p>		
<p>Unlocking tool for preLink® RJ45 module</p> <p>Set of 5 pieces</p> 	<p>20 82 000 9916</p>		
<p>HARTING Assembly tool for preLink® terminal module</p> 	<p>20 82 000 9901</p>		

Identification	Part number	
<p>HARTING RJ Industrial® Stripping Tool Stripping tool for Ethernet cables including blade cassette</p> <p>Spare blade cassette</p>	<p>09 45 800 0000</p> <p>09 45 800 0001</p>	 <p>The RJ Industrial Stripping Tool is ready to remove insulation from Ethernet cables for fast mounting with diameters from 2.5 to 8 mm quick and easy. It allows to remove cable sheath and shielding braid in one.</p>
<p>Stripping tool</p>	<p>09 45 800 0002</p>	
<p>HARTING M12 dynamometric screwdriver SW 18 or 13</p>	<p>09 99 000 0382</p>	
<p>Crimping tool for M12 Crimp</p>	<p>09 99 000 0501</p>	
<p>Cable shear</p>	<p>09 45 800 0004</p>	
<p>Wire cutter</p>	<p>09 45 800 0005</p>	
<p>HARTING RJ Industrial® Gigalink assembly tool</p>	<p>09 45 800 0520</p>	



Han® PushPull, type acc. to IEC 61 076-3-117 variant 14 RJ45 connector

Advantages

- HARTING PushPull technology
- Field-assembly connector with IDC contacts
- Fully shielded

Technical characteristics

Locking	PushPull technology acc. to IEC 61 076-3-117
Degree of protection	IP65/IP67
Mating face	RJ45 acc. to IEC 60 603-7
Shielding	Fully shielded, 360° shielding contact
Number of contacts	4 respectively 8
Transmission performance	acc. to ISO/IEC 11801, EN 50 173-1, Category 5, Class D up to 100 MHz, Category 6, Class E _A up to 500 MHz
Transmission rate	10/100 Mbit/s and 1/10 Gbit/s
Termination for Cat. 5	with IDC contacts, no tools needed/field-assembly
for Cat. 6	Conductor cross section AWG 24/7 - 22/7 (stranded) AWG 23/1 - 22/1 (solid)
	Cable diameter 1.6 mm
for Cat. 6	Conductor cross section AWG 22/7 - 27/7 (stranded) AWG 22/1 - 27/1 (solid)
	Cable diameter 1.6 mm
Mating cycles	min. 750
Temperature range	-40 °C ... +70 °C
Housing material	Plastic, black, UL 94 V0

Identification	Part number	Drawing	Dimensions in mm
----------------	-------------	---------	------------------

Connector set, plastic
incl. housing and male insert

Han® RJ Industrial
Category 5, 4 poles, IDC contacts
6.5 - 9.5 mm clamp range
5 - 8 mm clamp range

09 35 221 0421
09 35 222 0421

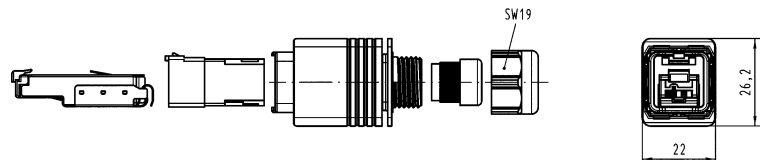

Han® RJ Industrial PN
Category 5, 4 poles, IDC contacts
6.5 - 9.5 mm clamp range
PROFINET-Identification:
PROFINET O-Plug RJ45

09 35 226 0421

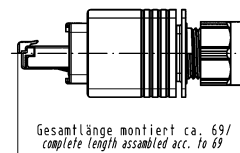

Gesamtlänge montiert ca. 69/
complete length assembled acc. to 69

Han® RJ Industrial 10G
Category 6, 8 poles, IDC contacts
6.5 - 9.5 mm clamp range
5 - 8 mm clamp range

09 35 225 0421
09 35 228 0421



Han® PushPull, type acc. to IEC 61 076-3-117 variant 14 RJ45 connector

Advantages

- HARTING PushPull technology
- Field-assembly connector with IDC contacts
- Fully shielded

Technical characteristics

Locking	PushPull technology acc. to IEC 61 076-3-117
Degree of protection	IP65/IP67
Mating face	RJ45 acc. to IEC 60 603-7
Shielding	Fully shielded, 360° shielding contact
Number of contacts	4 respectively 8
Transmission performance	acc. to ISO/IEC 11 801, EN 50 173-1, Category 5, Class D up to 100 MHz Category 6, Class E _A up to 500 MHz
Transmission rate	10/100 Mbit/s and 1/10 Gbit/s
Termination	with IDC contacts, no tools needed / field-assembly
for Cat. 5	
Conductor cross section	AWG 24/7 - 22/7 (stranded) AWG 23/1 - 22/1 (solid)
Cable diameter	1.6 mm
for Cat. 6	
Conductor cross section	AWG 22/7 - 27/7 (stranded) AWG 22/1 - 27/1 (solid)
Cable diameter	1.6 mm
Mating cycles	min. 750
Temperature range	-40 °C ... +70 °C
Housing material	Zinc die-cast, nickel-plated

Connecting hardware

Identification	Part number	Drawing	Dimensions in mm
----------------	-------------	---------	------------------

Connector set, metal
incl. housing
and male insert
6.5 - 9.5 mm clamp range

Han® RJ Industrial
Category 5, 4 poles, IDC contacts

09 35 221 0401

Han® RJ Industrial PN
Category 5, 4 poles, IDC contacts
PROFINET-Identification:
PROFINET O-Plug RJ45

09 35 226 0401

Han® RJ Industrial 10G
Category 6, 8 poles,
IDC contacts

09 35 225 0401

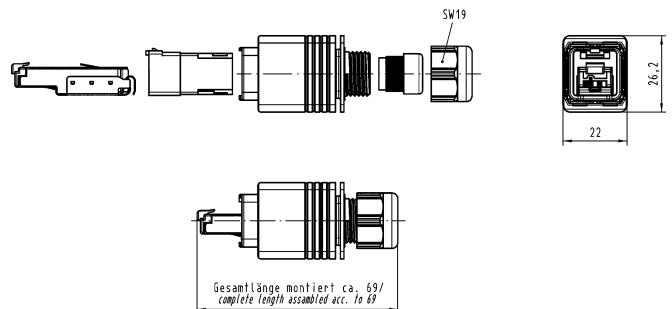

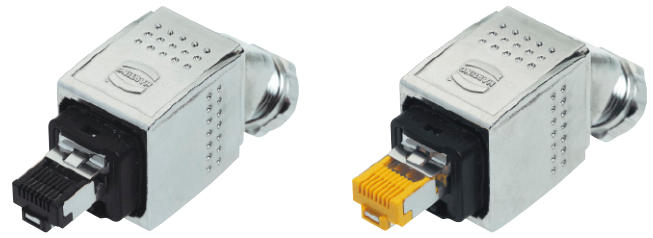

Han® PushPull, type acc. to IEC 61 076-3-117 variant 14
RJ45 connector angled

Advantages

- HARTING PushPull technology
- Angled cable exit 45° to the top/bottom for a space saving cabling
- Field-assembly connector with IDC contacts
- Fully shielded

Technical characteristics

Locking	PushPull technology acc. to IEC 61 076-3-117
Degree of protection	IP65/IP67
Mating face	RJ45 acc. to IEC 60 603-7
Shielding	Fully shielded, 360° shielding contact
Number of contacts	4 respectively 8
Transmission performance	acc. to ISO/IEC 11 801, EN 50 173-1, Category 5, Class D up to 100 MHz Category 6, Class E _A up to 500 MHz
Transmission rate	10/100 Mbit/s and 1/10 Gbit/s
Termination	with IDC contacts, no tools needed / field-assembly
for Cat. 5	
Conductor cross section	AWG 24/7 - 22/7 (stranded) AWG 23/1 - 22/1 (solid)
Cable diameter	1.6 mm
for Cat. 6	
Conductor cross section	AWG 22/7 - 27/7 (stranded) AWG 22/1 - 27/1 (solid)
Cable diameter	1.6 mm
Mating cycles	min. 750
Temperature range	-40 °C ... +70 °C
Housing material	Zinc die-cast, nickel-plated

Identification	Part number	Drawing	Dimensions in mm
Connector set, metal incl. housing and male insert Han® RJ Industrial PN Category 5, 4 poles, IDC contacts, 6.5 - 9.5 mm clamp range			
Cable exit bottom side	09 35 226 0402		
Cable exit top side	09 35 226 0403		
Han® RJ Industrial 10G Category 6, 8 poles, IDC contacts, 6.5 - 9.5 mm clamp range			
Cable exit bottom side	09 35 225 0402		
Cable exit top side	09 35 225 0403		



Han® PushPull, type acc. to IEC 61 076-3-117 variant 14 RJ45 connector

Advantages

- HARTING PushPull technology
- Compact design
- For space saving fitting conditions
- Connector with piercing contacts
- 360° shielding

Technical characteristics

Locking	PushPull technology acc. to IEC 61 076-3-117
Degree of protection	IP65/IP67
Mating face	RJ45 acc. to IEC 60603-7
Shielding	Fully shielded, 360° shielding contact
Number of contacts	8
Transmission performance	acc. to ISO/IEC 11801, EN 50 173-1, Category 6 _A , Class E _A up to 500 MHz
Transmission rate	10/100 Mbit/s and 1/10 Gbit/s
Termination	with piercing contacts
Conductor cross section	AWG 24/7 - 27/7 (stranded)
Cable diameter	1.05 mm
Mating cycles	min. 750
Temperature range	-40 °C ... +70 °C
Housing material	Zinc die-cast, nickel-plated Plastic, black, UL 94 V0

Connecting hardware

Identification	Part number	Drawing	Dimensions in mm
----------------	-------------	---------	------------------

Connector set, metal
incl. housing and male insert
6.5 - 9.5 mm clamp range

Han® RJ Industrial
Category 6, 8 poles,
piercing contacts

09 35 227 0401

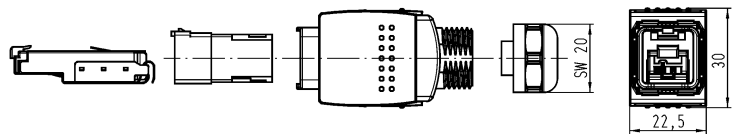

Connector set, plastic
incl. housing and male insert
5 - 8 mm clamp range

Han® RJ Industrial
Category 6_A, 8 poles,
piercing contacts

09 35 227 0421

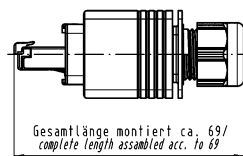
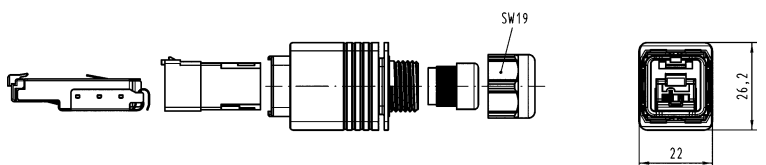

suitable assembly tool

09 45 800 0520

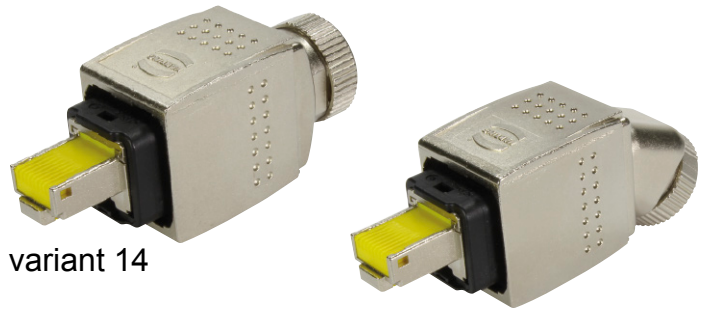

Han® PushPull, type acc. to IEC 61 076-3-117 variant 14
preLink® RJ45 connector, straight and angled

Advantages

- HARTING PushPull technology
- 45° angled cable entry, bottom side, for space saving cabling
- 360° shielding
- Category of transmission Cat. 6A
- Suitable for solid and stranded wires
- Suitable for PoE (IEEE 802.3af) and PoE+ (IEEE 802.3at)

Technical characteristics

Locking	PushPull technology acc. to IEC 61 076-3-117
Degree of protection	IP65/IP67
Mating face	RJ45 acc. to IEC 60603-7
Number of contacts	8
Transmission category	Category 6A, Class E _A , suitable for 1/10 Gigabit Ethernet
Transmission performance	Category 6A, Class E _A up to 500 MHz acc. to ISO/IEC 11801, EN 50173-1
Transmission rate	10/100 Mbit/s and 1/10 Gbit/s
Shielding	fully shielded, 360° shielding contact
Mounting	preLink® IDC termination
Cable termination for preLink® Connectable cables	terminal module, yellow, 20 82 000 0001
– Conductor cross section	AWG 23 ... AWG 22 (solid and stranded)
– Conductor diameter	1.3 ... 1.6 mm
Cable termination for preLink® Connectable cables	terminal module, white, 20 82 000 0003
– Conductor cross section	AWG 27 ... AWG 26 (solid and stranded)
– Conductor diameter	0.8 ... 1.1 mm
Cable diameter	6.3 ... 8.8 mm
Mating cycles	min. 750
Temperature range	-40 °C ... +70 °C
Housing material	Zinc die-cast, nickel-plated

Identification	Part number	Drawing	Dimensions in mm
Han® PushPull preLink® RJ45 connector, straight	20 82 104 0001		
Han® PushPull preLink® RJ45 connector, angled	20 82 104 0045		
Han® PushPull preLink® RJ45 connector plastic, straight	20 82 204 0001		
preLink® RJ45 terminal module	20 82 000 0001 20 82 000 0003 20 82 000 0005 20 82 000 0005 XL		
preLink® assembly tool	20 82 000 9901		

Further information and data sheets see www.HARTING.com

¹⁾ Packaging with 10 pieces

²⁾ Packaging with 100 pieces



Han® PushPull, type acc. to IEC 61 076-3-117 variant 14
RJ45 10G panel feed through

Advantages

- HARTING PushPull technology
- Compact design
- High packing density
- Device integration via RJ45 PCB connectors

Technical characteristics

Locking	PushPull technology acc. to IEC 61 076-3-117
Degree of protection	IP65/IP67
Mating face	RJ45 acc. to IEC 60 603-7
Transmission performance	acc. to ISO/IEC 11 801, EN 50 173-1, Category 5, Class D up to 100 MHz resp. Category 6, Class E _A up to 500 MHz
Transmission rate	10/100 Mbit/s and 1/10 Gbit/s
Number of contacts	8
Shielding	Fully shielded, 360° shielding contact (Cat. 6)
Mating cycles	min. 750
Temperature range	-40 °C ... +70 °C
Housing material	Plastic, black Zinc die-cast, nickel-plated
Flammability acc. to UL 94	V0

Connecting hardware

Identification	Part number	Drawing	Dimensions in mm
----------------	-------------	---------	------------------

Han® PushPull RJ45 10G

Panel feed through, Cat. 6 including bulkhead housing for rectangular panel cut out, flat seal and HARTING RJ Industrial® 10G RJ45 bulkhead, isolated bulkhead fixture

09 35 225 0311

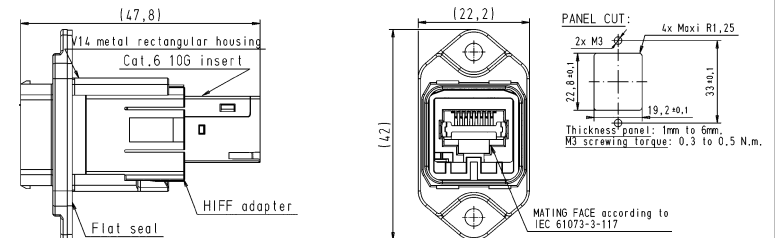

Panel feed through, Cat. 6 including bulkhead housing for circular panel cut out, flat seal and HARTING RJ Industrial® 10G RJ45 bulkhead, isolated bulkhead fixture

09 35 225 0312

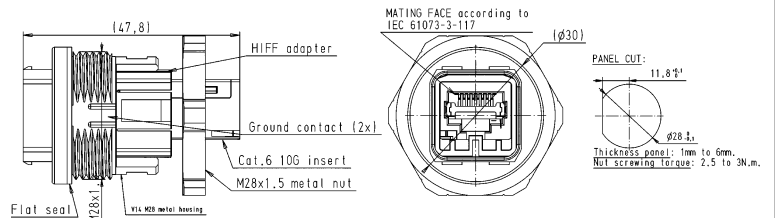

Han® PushPull RJ45

Panel feed through Cat. 6 including housing and HARTING RJ Industrial® 10G RJ45 bulkhead

09 35 225 0331

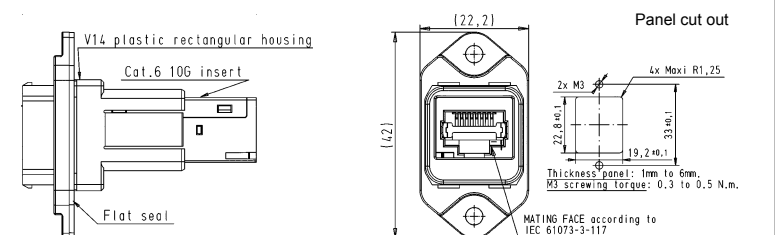

A large, empty grid area occupies the majority of the page. The grid consists of small, uniform squares, providing a space for taking notes or drawing diagrams. The grid lines are thin and light gray.

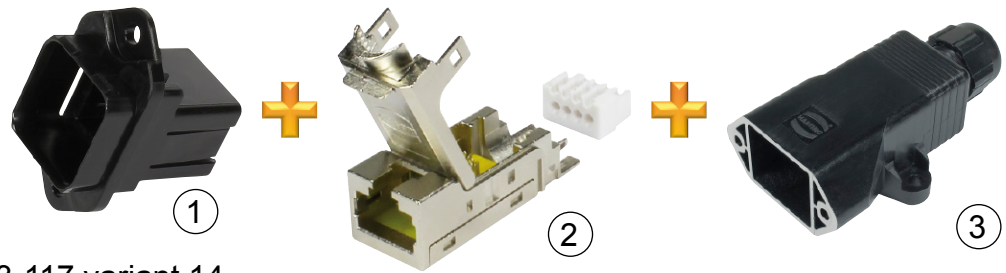

Han® PushPull,
type acc. to IEC 61076-3-117 variant 14
Housing bulkhead mounting and housing cable-to-cable combinations

Advantages

- Type/Material RJ45 / plastic or metal
- Category Cat. 5/Cat. 6_A
- Number of wires 4/8
- Termination IDC
- Cable diameter 5 - 9 mm

Application

- Industrial cabling
- On machines and control units

Benefits

- HARTING PushPull technology
- Compact design
- High packing density
- Device integration via RJ45 PCB connectors

Technical characteristics

- Connector type PushPull technology acc. to IEC 61076-3-117 variant 14
- Number of contacts 4 or 8 depending on type
- Transmission performance Category 5/6_A depending on type
- Transmission rate 10/100 Mbit/s / 1/ 10 Gbit/s
- Shielding fully shielded, 360° shielding contact
- Cable termination tool-less with IDC contacts or preLink® IDC
- Degree of protection IP65/IP67
- Temperature range -40 °C ... +70 °C
- Housing material plastic/metal

Identification	Part number	Drawing	Panel cut out Dimensions in mm
Han® PushPull V14 Housing bulkhead mounting			
panel feed-through plastic, black	09 35 012 0331		
panel feed-through metal for angular panel cut out, incl. plastic mounted adapter	09 35 012 0311		
panel feed-through metal for round panel cut out, incl. plastic mounted adapter and fixing nut (Not combinable with ③ !)	09 35 012 0312		

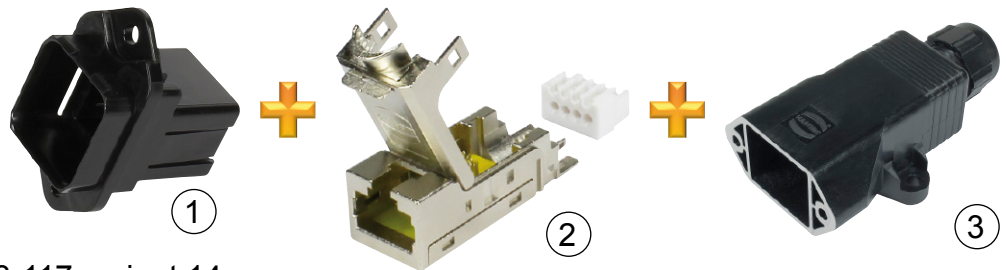

Han® PushPull,
type acc. to IEC 61076-3-117 variant 14
Housing bulkhead mounting and housing cable-to-cable combinations

Identification	Part number	Drawing	Dimensions in mm
RJ45 female inserts ② Cat. 5, 4 poles, 10/100 Mbit/s IDC for AWG 24-22 solid and stranded Cat. 6 _A , 8 poles, 10/100 Mbit/s and 1/10 Gbit/s IDC for AWG 28-24 solid and stranded Cat. 6 _A , 8 poles, 10/100 Mbit/s and 1/10 Gbit/s IDC for AWG 24-22 solid and stranded Cat. 6 _A , 8 poles, 10/100 Mbit/s and 1/10 Gbit/s preLink® IDC for AWG 23/22 solid and stranded Cat. 6 _A , 8 poles, 10/100 Mbit/s and 1/10 Gbit/s preLink® IDC for AWG 27/26 solid and stranded Cat. 6 _A , 8 poles, 10/100 Mbit/s and 1/10 Gbit/s preLink® IDC for AWG 23/22 or AWG 27/26 depending on the separately orderable preLink® terminal module (20 82 000 0001/20 82 000 0003) Cat. 6, 8 poles, 10/100 Mbit/s and 1/10 Gbit/s RJ45 system cable jack on connector	 09 45 545 1120 09 45 545 1561 09 45 545 1562 20 82 001 0001 20 82 001 0002 20 82 000 0002 0.15 m up to 10.0 m 09 45 545 1500 09 45 545 1518		 13,15 15,6
Han® PushPull Housing cable-to-cable ③ plastic, black (not in combination with Housing bulkhead mounting 09 35 012 0312!) for cable outer diameter 6.5 ... 9.5 mm for cable outer diameter 9 ... 13 mm	 09 35 002 0431 09 35 002 0433	2X REMFORM $\phi 3 \times 8$ TORX screws 	 70 54,5 22,4



Han® PushPull RJ45 Gender changer Metal
Cat. 6, Class E_A

Advantages

- High degree of protection IP65/IP67
- Robust metal housing
- Standard PROFINET component of the German automotive production
- Allows usage of different cable types (Type B, C) e.g. in robots application
- Extension of cords according to PROFINET guideline
- Can be count as one connection acc. to IEC 11801 Chapter 10.2.4

Technical characteristics

Transmission performance	Cat. 6, Class E _A up to 500 MHz
Connector	Han® PushPull RJ45 (PROFINET conform)
Locking	PushPull technology acc. to IEC 61076-3-117 variant 14
Mating face	RJ45 acc. to IEC 60603-7
Mating cycles	min. 750
Housing material	Aluminium anodized
Dimensions	61.2 x 62 x 25.2 mm (unmated)
Degree of protection acc. to DIN 60529	IP65/IP67 (mated)
Mounting	Wall mountable with 4 screws (type M5)
Temperature range	-40 °C ... +70 °C
Maximum permissible humidity	30 % ... 95 % (no condensation)

Connecting hardware

Identification	Part number	Drawing	Dimensions in mm
----------------	-------------	---------	------------------

Han® PushPull RJ45
Gender changer metal

09 35 221 0501

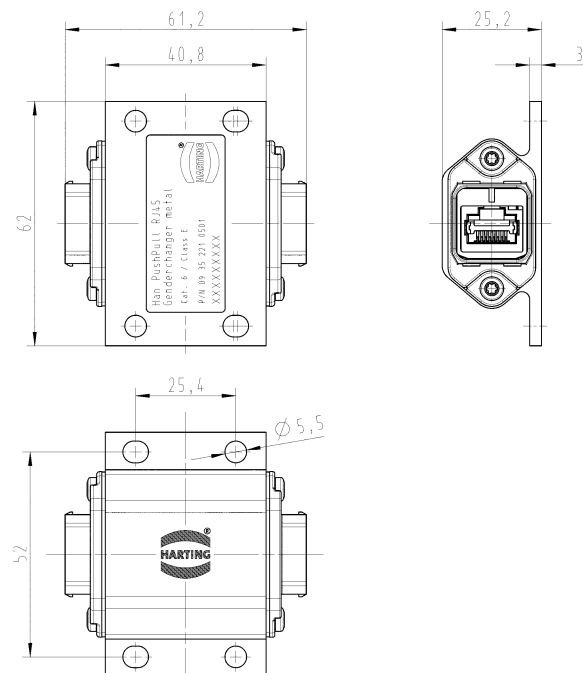



Han® PushPull RJ45 Coupling Metal
Cat. 6, Class E_A

Advantages

- High degree of protection IP65/IP67
- Robust metal housing
- Standard PROFINET component of the German automotive production
- Extension of cords according to PROFINET guideline
- Can be count as one connection acc. to IEC 11801 Chapter 10.2.4
- For an easy robot termination and a fast exchange of tube packages

Technical characteristics

Transmission performance	Cat. 6, Class E _A up to 500 MHz
Transmission rate	10/100 Mbit/s and 1/10 Gbit/s
Locking	PushPull technology acc. to IEC 61076-3-117 variant 14
Mating face	RJ45 acc. to IEC 60603-7
Number of contacts	8
Usable cables	
Termination cross section	AWG 22-24 stranded/solid
Cable diameter	5 ... 9 mm
Conductor diameter	1.3 ... 1.6 mm
Mating cycles	min. 750
Housing material	Aluminium die-cast
Degree of protection acc. to DIN 60529	IP65/IP67
Temperature range	-40 °C ... +70 °C

Identification	Part number	Drawing	Dimensions in mm
----------------	-------------	---------	------------------

Han® PushPull RJ45 Coupling metal including housing, preLink® RJ45 jack, bulkhead housing and cable gland	61 04 201 1084		
	61 04 600 0182		



Han® PushPull Metal Outlet acc. to IEC 61 076-3-117 variant 14
Cat. 6A, 8 poles

Advantages

- Simple mounting, fixing and earth connection both outside
- Fast termination of data cables due to Ha-VIS preLink® technology
- Structured cabling for industrial premises
- Mating face AIDA compliant, protection cover incl.
- PROFINET compatible

Technical characteristics

Number of ports, Copper/Termination	2 x Han® PushPull (V14) RJ45 (IP65/IP67) or Han® 3 A RJ45
Transmission performance	Category 6, Class E _A up to 500 MHz acc. to ISO/IEC 11801, EN 50 173-1
Transmission rate	up to 10 Gbit/s
Termination	preLink®
Wire gauge	AWG 24 ... 22 (0.25 mm ² ... 0.34 mm ²) solid and stranded
Strand diameter	Ø 1.3 mm ... 1.6 mm
Cable diameter	7.2 mm ... 8 mm
Shielding	Fully shielded 360° flexible shielding termination
Mounting	Wall mounting
Dimensions (H x W x D)	105 x 105 x 40.5 mm
Degree of protection	IP65/IP67
Operating temperature range	-40 °C ... +70 °C
Housing material	Aluminium, die-cast
Colour	Black

Identification	Part number	Drawing	Dimensions in mm
----------------	-------------	---------	------------------

preLink®
Han® PushPull Metal Outlet



20 82 104 0101

consists of:

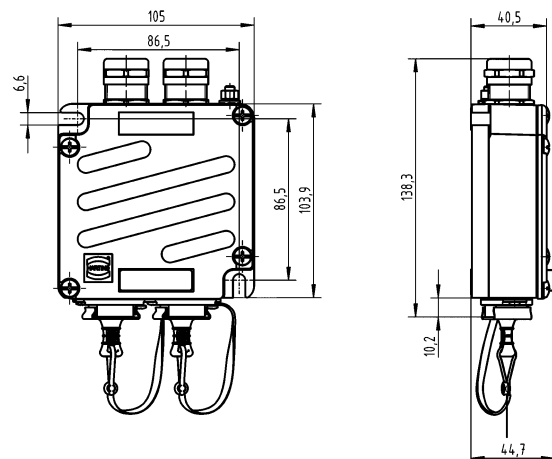
- 1x Housing including protection covers
- 2x preLink® Set RJ45 jack AWG 22/23
- 2x Cable gland with slotted seal
- 1x Assembly instruction



Han® PushPull, type acc. to IEC 61 076-3-117 variant 14 Accessories

Identification	Part number	Drawing	Dimensions in mm
Han® PushPull protection cover IP65/IP67 for device side without fixing cord with fixing cord with nylon fixing cord	 09 35 002 5403 XL ¹⁾ 09 35 002 5402 09 35 002 5402 XL ¹⁾ 09 35 002 5404 09 35 002 5404 XL ²⁾		
Han® PushPull protection cover IP65/IP67 for cable side without fixing cord with nylon fixing cord	 09 35 002 5411 09 35 002 5413		

¹⁾ Packaging with 100 pieces
²⁾ Packaging with 250 pieces

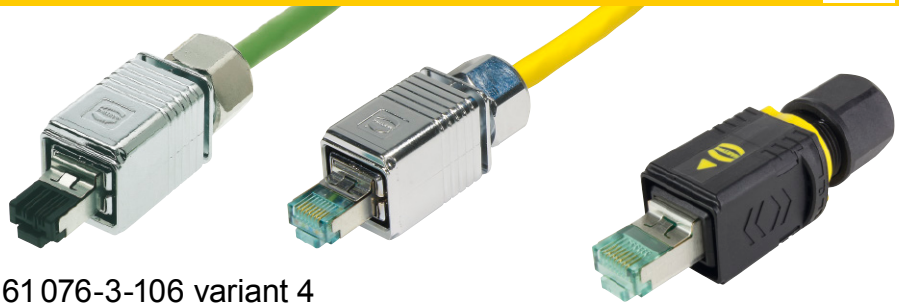

HARTING PushPull acc. to IEC 61 076-3-106 variant 4 RJ45 connector

Advantages

- Ethernet connector based on RJ45
- Fully shielded, 360° shielding contact
- Field-assembly connector with IDC contacts (Cat. 5 versions) or piercing contacts (Cat. 6_A versions)

Technical characteristics

Locking	PushPull Technology acc. to IEC 61076-3-106 variant 4
Degree of protection	IP65/IP67
Mating face	RJ45 acc. to IEC 60603-7
Cable diameter	4.9 ... 8.6 mm (metal version) 4.5 ... 10 mm (plastic version)
Termination cross section	
Cat. 5	AWG 24/7 ... AWG 22/7 (stranded) AWG 23/1 ... AWG 22/1 (solid)
Cat. 6 _A	AWG 24/7 ... AWG 28/7 (stranded)
Mating cycles	min. 750
Temperature range	-40 °C ... +70 °C
Housing material	Plastic, black Zinc die-cast, shining
Flammability acc. to UL 94	V0
	UL approval (E102079)

Connecting hardware

Identification	Part number	Drawing	Dimensions in mm
<p>Connector, 4 poles Cat. 5</p> <p>incl. housing with RJ45 connector, shielding and cable gland</p>	<p>09 45 145 1106 09 45 195 1100 (metal version)</p>		
<p>Connector, 8 poles Cat. 6_A</p> <p>incl. housing with RJ45 connector, shielding and cable gland</p>	<p>09 45 145 1521 09 45 145 1521 XL¹⁾ 09 45 195 1520 (metal version)</p>		
<p>suitable assembly tool</p>	<p>09 45 800 0520</p>		

¹⁾ Packaging with 100 sets



HARTING PushPull acc. to IEC 61 076-3-106 variant 4 RJ45 connector

Advantages

- Ethernet connector based on RJ45
- Fully shielded, 360° shielding contact
- Field-assembly connector with IDC contacts
- Category of transmission: Cat. 6, Class E_A suitable for 1/10 Gbit Ethernet

Technical characteristics

Locking	PushPull Technology acc. to IEC 61076-3-106 variant 4
Mating face	RJ45 acc. to IEC 60 603-7
Cable diameter	4.9 ... 8.6 mm (metal version) 4.5 ... 10 mm (plastic version)
Termination cross section	AWG 27/7 ... AWG 22/7 (stranded) AWG 24/1 ... AWG 22/1 (solid)
Conductor diameter	max. 1.6 mm (incl. insulation)
Mating cycles	min. 750
Degree of protection	IP65/IP67
Temperature range	-40 °C ... +70 °C
Housing material	Plastic, black Zinc die-cast, shining
Flammability acc. to UL 94	V0 UL approval (E102079)



Identification	Part number	Drawing	Dimensions in mm
----------------	-------------	---------	------------------

Connector, 8 poles
Cat. 6
incl. housing with RJ45 connector,
shielding and cable gland

09 45 145 1561

09 45 195 1560
(metal version)

Colour clips
for colour coding the HARTING
PushPull connectors

Blue	09 45 840 0008
Violet	09 45 840 0007
Green	09 45 840 0006
Red	09 45 840 0005
Yellow	09 45 840 0004

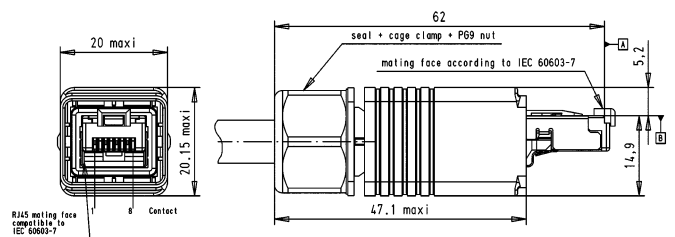

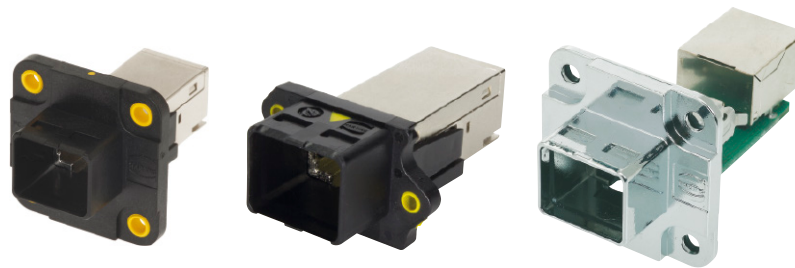

HARTING PushPull acc. to IEC 61 076-3-106 variant 4
RJ45 panel feed-throughs

Advantages

- Small, space-saving PushPull Interfaces in IP65/IP67
- Easy handling of RJ45 patch cords in switch cabinets or sets
- Mounting to casings

Technical characteristics

Locking	PushPull Technology acc. to IEC 61 076-3-106 variant 4
Transmission rate Cat. 5 versions	10/100/1000 Mbit/s
Transmission rate Cat. 6 versions	10/100 Mbit/s 1/ 10 Gbit/s
Shielding	fully shielded, 360° shielding contact
Mating cycles	min. 750
Degree of protection	IP65/IP67
Temperature range	-40 °C ... +70 °C
Housing material	Plastic, black Zinc die-cast, shining
Flammability acc. to UL 94	V0
	UL approval (E102079)

Connecting hardware

Identification	Part number	Drawing	Dimensions in mm
<p>Panel feed-through set category of transmission Cat. 5</p> <p>incl. housing bulkhead mounting EasyInstall metal with integrated seal, 2 x RJ45-jack board drillings for M3</p>	09 45 295 1130		
<p>Panel feed-through set category of transmission Cat. 6</p> <p>incl. housing bulkhead mounting EasyInstall with integrated seal, 2 x RJ45-jack board drillings for M3</p>	09 45 245 1590		
<p>incl. housing bulkhead mounting Compact, with integrated seal, 2 x RJ45-jack</p>	09 45 245 1561		



HARTING PushPull acc. to IEC 61 076-3-106 variant 4
RJ45 – bulkhead

Advantages

- Small, space-saving PushPull Interfaces in IP65/IP67
- Easy connection of PushPull RJ45 system cords
- Screwable with 2 x M3 screws

Technical characteristics

Locking	PushPull Technology acc. to IEC 61 076-3-106 variant 4
Number of contacts	8
Transmission category	Cat. 6, performance class E _A , suitable for 1/10 Gigabit Ethernet
Transmission rate	10/100 Mbit/s 1/ 10 Gbit/s
Shielding	fully shielded, 360° shielding contact
Mating cycles	min. 750
Degree of protection	IP65/IP67
Temperature range	-40 °C ... +70 °C
Housing material	Plastic, black
Flammability acc. to UL 94	V0
	UL approval (E102079)

Identification

Part number

Drawing

Dimensions in mm

HARTING PushPull RJ45 –
bulkhead

09 45 345 1560

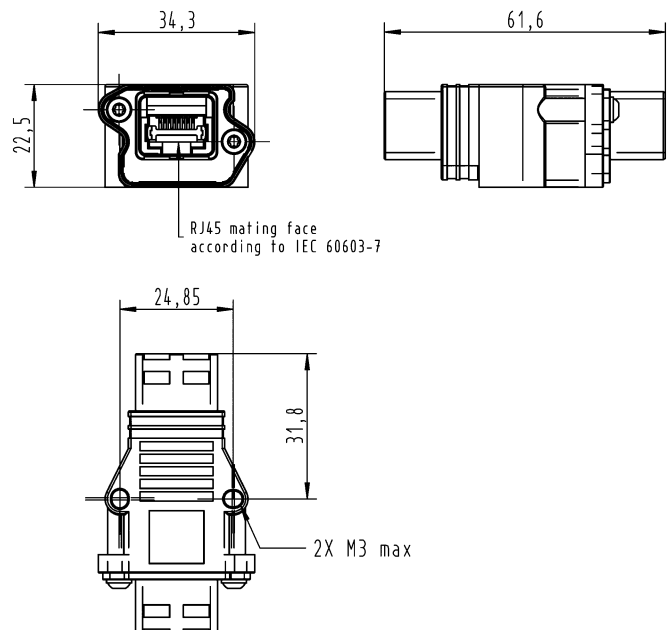

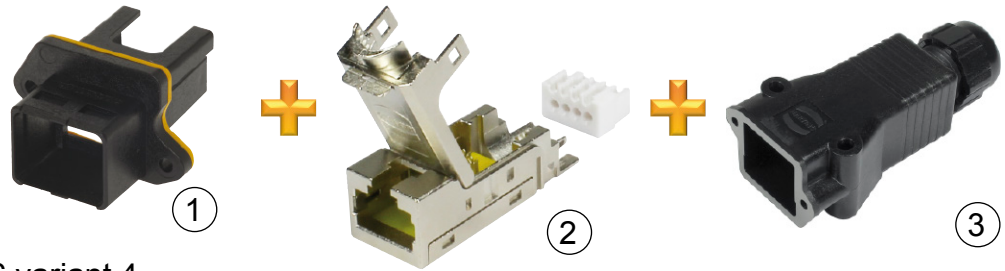

HARTING PushPull
acc. to IEC 61 076-3-106 variant 4
Housing bulkhead mounting and housing cable-to-cable combinations

Advantages

- Type/Material RJ45 plastic
- Category Cat. 5/Cat. 6A
- Number of wires 4/8
- Termination IDC
- Outer diameter 5 - 9 mm

Application

- Industrial cabling
- On machines and control units
- Outdoor

Benefits

- HARTING PushPull technology
- Compact design
- High packing density
- Device integration via RJ45 PCB connectors

Technical characteristics

- Connector type HARTING PushPull (V4) RJ45 connector acc. to IEC 61 076-3-106 variant 4
- Number of contacts 4 or 8 depending on type
- Transmission performance Category 5/6A depending on type
- Transmission rate 10/100 Mbit/s / 1/ 10 Gbit/s depending on type
- Shielding fully shielded, 360° shielding contact
- Cable termination tool-less with IDC contacts or preLink® IDC
- Degree of protection IP65/IP67
- Temperature range -40 °C ... +70 °C
- Housing material polycarbonate, UL 94 V0, black

Identification	Part number	Drawing	Dimensions in mm
HARTING PushPull V4 Housing bulkhead mounting 1 Housing bulkhead mounting – Compact with integrated seal, mounting drills for M2.5 plastic, black Housing bulkhead mounting – EasyInstall with integrated seal, mounting drills for M3 plastic, black (Not combinable with 3 !)	09 45 545 0028 09 45 545 0032		

PushPull RJ45 IP65/IP67 connectors

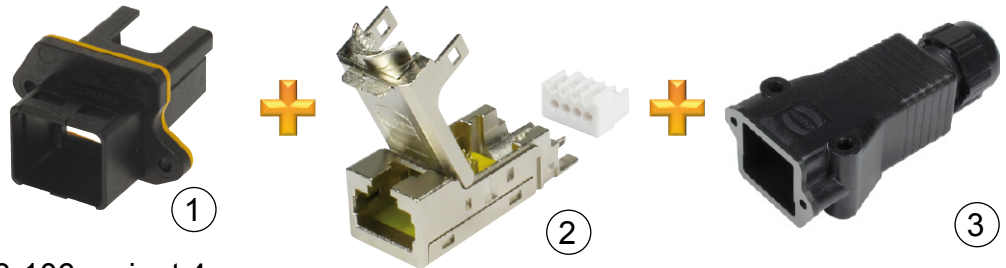

HARTING PushPull,
type acc. to IEC 61076-3-106 variant 4
Housing bulkhead mounting and housing cable-to-cable combinations

Identification	Part number	Drawing	Dimensions in mm
RJ45 female inserts ② Cat. 5, 4 poles, 10/100 Mbit/s IDC for AWG 24-22 solid and stranded Cat. 6 _A , 8 poles, 10/100 Mbit/s and 1/10 Gbit/s IDC for AWG 28-24 solid and stranded Cat. 6 _A , 8 poles, 10/100 Mbit/s and 1/10 Gbit/s IDC for AWG 24-22 solid and stranded Cat. 6 _A , 8 poles, 10/100 Mbit/s and 1/10 Gbit/s preLink® IDC for AWG 23/22 solid and stranded Cat. 6 _A , 8 poles, 10/100 Mbit/s and 1/10 Gbit/s preLink® IDC for AWG 27/26 solid and stranded Cat. 6 _A , 8 poles, 10/100 Mbit/s and 1/10 Gbit/s preLink® IDC for AWG 23/22 or AWG 27/26 depending on the separately orderable preLink® terminal module (20 82 000 0001/20 82 000 0003) Cat. 6, 8 poles, 10/100 Mbit/s and 1/10 Gbit/s RJ45 system cable jack on connector 0.15 m 10.0 m	09 45 545 1120 09 45 545 1561 09 45 545 1562 20 82 001 0001 20 82 001 0002 20 82 000 0002 09 45 545 1500 up to 09 45 545 1518	 	13,15 15,6
HARTING PushPull Housing cable-to-cable ③ plastic, black for cable outer diameter 6.5 ... 9.5 mm HARTING PushPull Housing bulkhead mounting extern, plastic, black (Not combinable with EasyInstall Housing bulkhead mounting 09 45 545 0032!)	09 45 345 0000 09 45 345 0001	2X M2.5x10 self tapping screws according to EN ISO 7092 2X M2.5x10 self tapping screws according to EN ISO 7092 	



HARTING PushPull acc. to IEC 61 076-3-106 variant 4
RJ45 Outlet, Cat. 6, 8 poles

Advantages

- Simple mounting
- Cable entering optionally from bottom or from top side
- Self-closing protection caps in IP65/IP67
- IP65/IP67 label

Technical characteristics

Number of ports, Copper/Termination	2 x HARTING PushPull (V4) RJ45 (IP65/IP67)
Transmission performance	Category 6, Class E up to 250 MHz according to ISO/IEC 11801, EN 50 173-1
Transmission rate	10/100/1000 Mbit/s
Termination	Via IDC contacts, tool-less
Wire gauge	AWG 24 ... 22 (0.25 mm ² ... 0.34 mm ²) solid and stranded
Strand diameter	0.7 mm ... 1.6 mm
Cable diameter	6 mm ... 9 mm
Shielding	Fully shielded, 360° shielding contact
Mounting	Wall mounting
Dimensions (H x W x D)	152 x 90 x 69 mm
Degree of protection	IP65/IP67
Operating temperature range	-20 °C ... +70 °C
Housing material	polycarbonate, UL94 V-0
Colour	Black (similar RAL 9011) or White (similar RAL 9010)

Connecting hardware

Identification	Part number	Drawing	Dimensions in mm
----------------	-------------	---------	------------------

HARTING PushPull RJ45 Outlet

Black
white

09 45 845 1500
09 45 845 1501

consisting of:
2-port outlet housing with protection caps, cable management, cable glands and label
2x RJ45 female modules, Category 6
1x blind plug (if only 1 cable is used)
Assembly instructions

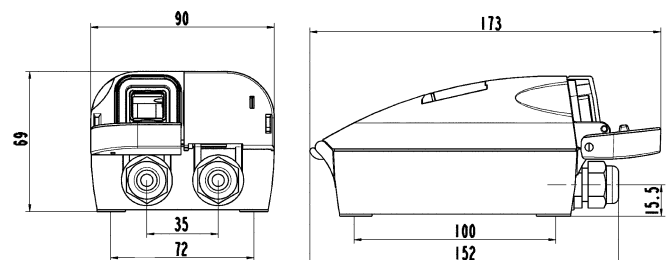

Identification	Part number	Drawing	Dimensions in mm
Transport protection for device side IP40	09 45 845 0003		
Protection cover for device side IP65/IP67			
Version with passive locking without cord	09 45 845 0009 024		
Version with passive locking with plastic cord for fixing screw M3	09 45 845 0009		
Version with passive locking with nylon cord for fixing screw M2.5/M3	09 45 845 0011 024		
Version with active locking without cord	09 45 845 0015		
Version with active locking with plastic cord for fixing screw M3	09 45 845 0014		
Version with active locking with nylon cord for fixing screw M2.5/M3	09 45 845 0013		
Protection cover for connectors IP65/IP67	09 45 845 0010		
Security clip for connectors can be sealed and protects against unauthorized unplugging	09 45 845 0020		
Blinding plate to close PushPull Compact panel cuttings	09 45 845 0019		

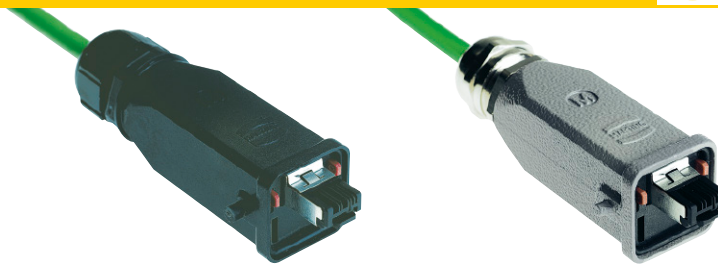

Han® 3 A connector RJ45, 4 poles, Cat. 5

Advantages

- RJ45 Ethernet-Data connector suitable for industry
- Tool-less field-assembly with *HARAX*® rapid termination in IDC technology
- Category of transmission Cat. 5
- Compact design and very robust housing
- Suitable for termination of solid and stranded cables
- Up to 10 x reconductable
- PROFINET compatible
- Min. 500 mating cycles

Technical characteristics

Connector type	Han® 3 A Connector RJ45 acc. to IEC 61076-3-106 variant 5
Number of contacts	4
Transmission performance	Category 5, Class D up to 100 MHz acc. to ISO/IEC 11801, EN 50 173-1
Transmission rate	10/100 Mbit/s
Shielding	fully shielded, 360° shielding contact
Cable termination	tool-less with IDC contacts
Conductor cross section	
stranded	AWG 24/7 - AWG 22/7
solid	AWG 23/1 - AWG 22/1
Conductor diameter	max. 1.6 mm
Cable outer diameter	5 mm – 9 mm
Degree of protection	IP65/IP67
Temperature range	-40 °C ... +70 °C
Housing material	
Plastic version	polycarbonate, UL 94 V0, black
Metal versions	
Standard	Zinc die-cast, powder coating grey
M-version	Zinc die-cast, powder coating black

Identification	Part number	Drawing	Dimensions in mm
Han® 3 A connector set RJ45, 4 poles incl. housing, cable gland and instruction manual			
Plastic version, black	straight 09 45 125 1100 angled 09 45 125 1104		
Metal version Standard, grey	straight 09 45 115 1100 angled 09 45 115 1104		
Metal version M, black	straight 09 45 115 1102 angled 09 45 115 1106		
Coding pin set	09 45 820 0000		

Dimensions valid for plastic version, straight



Han® 3 A RJ45 10G connector, 8 poles, Cat. 6

Advantages

- RJ45 Ethernet-Data connector suitable for industry
- Tool-less field-assembly with *HARAX*® rapid termination in IDC technology
- Category of transmission Cat. 6
- Compact design and very robust housing
- Suitable for termination of solid and stranded cables
- PROFINET compatible
- Min. 500 mating cycles

Technical characteristics

Connector type	Han® 3 A Connector RJ45 acc. to IEC 61076-3-106 variant 5
Number of contacts	8
Transmission performance	Category 6, Class E _A up to 500 MHz acc. to ISO/IEC 11801, EN 50173-1
Transmission rate	10/100 Mbit/s and 1/10 Gbit/s
Shielding	fully shielded, 360° shielding contact
Cable termination	tool-less with IDC contacts
Conductor cross section	
stranded	AWG 27/7 - AWG 22/7
solid	AWG 24/1 - AWG 22/1
Conductor diameter	max. 1.6 mm
Cable outer diameter	5 mm – 9 mm
Degree of protection	IP65/IP67
Temperature range	-40 °C ... +70 °C
Housing material	
Plastic version	polycarbonate, UL 94 V0, black
Metal versions	
Standard	Zinc die-cast, powder coating grey

Identification	Part number	Drawing	Dimensions in mm
----------------	-------------	---------	------------------

Han® 3 A RJ45 connector, 8 poles
incl. housing, cable gland
and instruction manual

Plastic version, black	straight	09 45 125 1560
Metal version Standard, grey	straight	09 45 115 1560
Han® 3 A RJ45 connector insert can be combined with Han® 3 A housing	straight	09 45 100 1560
Coding pin set		09 45 820 0000

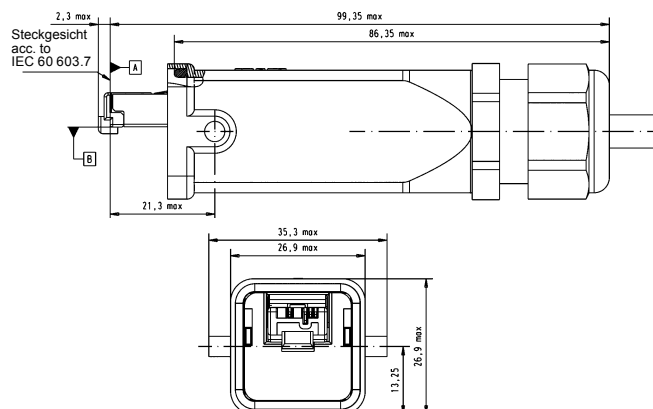

Dimensions valid for plastic version, straight



Han® 3 A connector set RJ45, 8 poles, Cat. 6_A

Advantages

- RJ45 Ethernet-Data connector suitable for industry
- Field-assembly with mounting tool
- Category of transmission Cat. 6_A
- Compact design and very robust housing
- Min. 500 mating cycles

Technical characteristics

Connector type	Han® 3 A Connector RJ45
Number of contacts	8
Transmission performance	Category 6 _A , Class E _A up to 500 MHz acc. to ISO/IEC 11801, EN 50 173-1
Transmission rate	10/100 Mbit/s and 1/10 Gbit/s
Shielding	fully shielded, 360° shielding contact
Cable termination	with piercing contacts
Conductor cross section	AWG 28/7 - AWG 24/7, stranded
Conductor diameter	max. 1.05 mm
Cable outer diameter	5 mm – 9 mm
Degree of protection	IP65/IP67
Temperature range	-40 °C ... +70 °C
Housing material	polycarbonate, UL 94 V0, black
Plastic version	
Metal versions	
Standard	Zinc die-cast, powder coating grey
M-version	Zinc die-cast, powder coating black

Connecting hardware

Identification	Part number	Drawing	Dimensions in mm
Han® 3 A connector set RJ45, 8 poles, Cat. 6 incl. housing, cable gland and instruction manual		<p>Mating face acc. to IEC 60603-7</p>	
Plastic version, black	09 45 125 1520		
Metal version Standard, grey	09 45 115 1520		
Metal version M, black	09 45 115 1522		
Han® 3 A RJ45 connector insert can be combined with Han® 3 A housing	09 45 100 1520		
Coding pin set	09 45 820 0000		
suitable assembly tool	09 45 800 0520		

Dimensions valid for metal version Standard



Han® 3 A RJ45 connector

Advantages

- Type/Material RJ45 plastic, metal
- Category Cat. 5/Cat. 6_A
- Number of wires 4/8
- Termination IDC
- Outer diameter 5 - 13 mm

Application

- Industrial cabling
- On machines, devices and control units

Benefits

- RJ45 Ethernet-Data connector suitable for industry
- Tool-less field-assembly with HARAX® rapid termination in IDC technology
- Compact design and very robust housing
- Suitable for termination of solid and stranded cables
- PROFINET compatible
- Min. 500 mating cycles

Technical characteristics

Connector type	Han® 3 A connector RJ45 acc. to IEC 61076-3-106 variant 5
Number of contacts	4/8 depending on type
Transmission performance	Category 5/6 _A depending on type
Transmission rate	10/100 Mbit/s 1/ 10 Gbit/s
Shielding	fully shielded, 360° shielding contact
Cable termination	tool-less with IDC contacts or preLink® IDC
Degree of protection	IP65/IP67
Temperature range	-40 °C ... +70 °C
Housing material	plastic version polycarbonate, UL 94 V0, black
metal version	Zinc die-cast, powder coating grey
Standard	Zinc die-cast, powder coating black
M version	



Han® 3 A RJ45 connector

Identification	Part number	Drawing	Dimensions in mm
Han® 3 A RJ45 connector inserts ① Cat. 5, 4 poles, 10/100 Mbit/s IDC for AWG 24-22 solid and stranded Cat. 5, 4 poles, 10/100 Mbit/s IDC for AWG 26-24 solid and stranded Cat. 6, 8 poles, 10/100 Mbit/s and 1/10 Gbit/s IDC for AWG 27-22 solid and stranded Cat. 6A, 8 poles, 10/100 Mbit/s and 1/10 Gbit/s piercing termination for AWG 28-26 stranded Cat. 6A, 4/8 poles, 10/100 Mbit/s and 1/10 Gbit/s preLink® IDC for AWG 23/22 or AWG 27/26 depending on the separately orderable preLink® terminal module (20 82 000 0001/20 82 000 0003)	09 45 100 1100 09 45 100 1110 09 45 100 1560 09 45 100 1520 20 82 002 0001	<p>Technical drawings of connector inserts. The top drawing shows contact cavities 1, 2, 3, and 6 with a width of 21 maxi and a height of 21 maxi. The bottom drawing shows contact 1 and contact 8 with a width of 21 maxi and a height of 21 maxi.</p>	<p>Technical drawings of the connector housing and plug insert. The top drawing shows the Han 3A adapter with a 4 poles plug insert, an M3 screw, and dimensions: 44,5 (total width), 26 (insert width), and 11 (screw offset). The bottom drawing shows the Han 3A adapter with a Cat. 6 insert, an M3 screw, and dimensions: 44,5 (total width), 26 (insert width), and 11 (screw offset).</p>
Han® 3 A connector housing M20 (with glued seal) ② straight cable entry: – metal, grey – metal, black – plastic, grey – plastic, black – metal, EMC – stainless steel angled cable entry: – metal, grey – metal, black – plastic, grey – plastic, black – metal, EMC – stainless steel	19 20 003 1443 19 37 003 1443 19 20 003 0423 19 20 003 0423 19 62 003 1443 19 44 003 1443 19 20 003 1643 19 37 003 1643 19 20 003 0623 19 20 003 0626 19 62 003 1643 19 44 003 1643	<p>Technical drawings of the M20 connector housing. The top drawing shows a straight cable entry with a height of 60 and a width of 28. The bottom drawing shows an angled cable entry with a height of 54,5 and a width of 33,5. Both drawings show an M20x1,5 thread and a seal.</p>	<p>Technical drawings of the M20 connector housing. The top drawing shows a straight cable entry with a height of 60 and a width of 28. The bottom drawing shows an angled cable entry with a height of 54,5 and a width of 33,5. Both drawings show an M20x1,5 thread and a seal.</p>

Connecting hardware



Han® 3 A RJ45 connector

Identification	Part number	Drawing	Dimensions in mm
M20 cable glands ③ metal: – 5 ... 9 mm – 5 ... 12 mm – 6 ... 12 mm – 10 ... 14 mm plastic, grey: – 5 ... 9 mm – 6 ... 12 mm – 10 ... 14 mm plastic, black: – 5 ... 9 mm – 6 ... 12 mm – 10 ... 14 mm metal, EMC version: – 6.5 ... 9.5 mm – 4.0 ... 6.5 mm – 7.0 ... 10.5 mm – 9.0 ... 13.0 mm stainless steel: – 6 ... 13 mm			
Accessories coding pin set for 4 different codings	09 45 820 0000		



Han® 3 A RJ45 panel feed-throughs and couplings Cat. 5

Identification	Part number	Drawing	Dimensions in mm
Panel feed-through set, 8 poles Plastic version, black angled 09 45 225 1108 Metal version Standard, grey angled 09 45 215 1108 Metal version M, black angled 09 45 215 1109 Coding pin set for 4 different codings 09 45 820 0000		<p>Dimensions valid for plastic version</p>	
Double coupling, 8 poles incl. installation frame metal Plastic version, black 09 45 225 1107 Metal version Standard, grey 09 45 215 1107 Metal version M, black 09 45 215 1110 Coding pin set for 4 different codings 09 45 820 0000		<p>Dimensions valid for plastic version</p>	
Protection cover for panel feed-through IP65/IP67 with seal Plastic version, black 09 20 003 5449 Metal version Standard, grey 09 20 003 5425 Metal version M, black 09 37 003 5405		<p>Dimensions valid for plastic version</p>	

Connecting hardware



Han® 3 A RJ45 10G Cat. 6 – panel feed-throughs

Advantages

- Compact and robust design
- 360° shielding
- Easy mounting
- Transmission Category 6, performance class E_A, suitable for 1/10 Gigabit Ethernet
- RJ45 mating compatible
- Coding (4 variants) possible

Technical characteristics

Number of ports	2/ 1x Han® 3 A RJ45 (IP65/IP67) 1x RJ45 (IP20)
Transmission performance	Category 6, Class E _A acc. to ISO/IEC 11801, EN 50 173-1
Transmission rate	10/100 Mbit/s and 1/10 Gbit/s
Shielding	Fully shielded, 360° shielding contact
Mounting	Screwable to cover plates
Degree of protection	IP65/IP67
Mating cycles	min. 500
Temperature range	-40 °C ... + 70 °C
Housing material	
Plastic version	polycarbonate, black, UL 94 V0
Metal version	Zinc die-cast, powder-coated

Identification

Part number

Drawing

Dimensions in mm

Panel feed-through set, 8 poles

- Plastic version, black
- Metal version Standard, grey
- Metal version M, black

09 45 225 1560
09 45 215 1560
09 45 215 1561

- Metal version Standard, grey, with self-closing protective cap

09 45 215 1562

Han® 3 A RJ45 10G insert Cat. 6 (for Han® 3 A housings)

09 45 200 1560

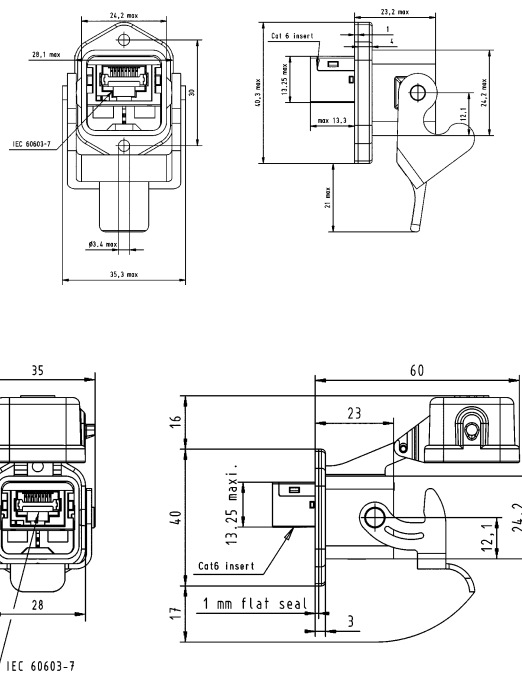

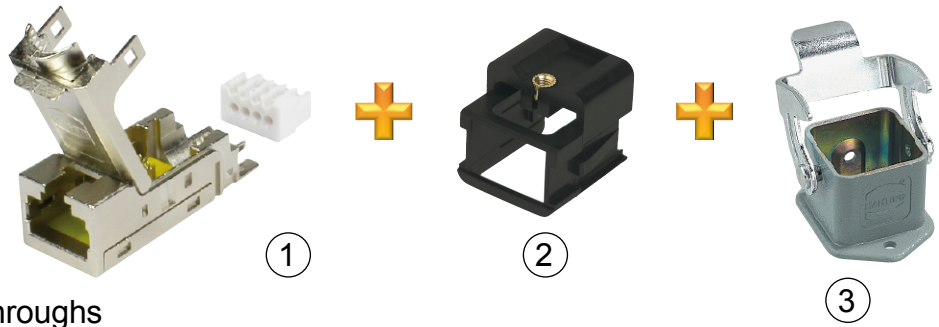

Han® 3 A RJ45 panel feed-throughs

Advantages

- Type/Material RJ45 plastic, metal
- Category Cat. 5/Cat. 6_A
- Number of wires 4/8
- Termination IDC
- Outer diameter 5 - 9 mm

Application

- Industrial cabling
- On machines, devices and control units

Benefits

- Compact and robust design
- 360° shielding
- Easy mounting
- RJ45 mating compatible
- Coding (4 variants) possible

Technical characteristics

Connector type	Han® 3 A connector RJ45 acc. to IEC 61076-3-106 variant 5
Number of contacts	4/8 depending on type
Transmission performance	Category 5/6 _A depending on type
Transmission rate	10/100 Mbit/s 1/ 10 Gbit/s
Shielding	fully shielded, 360° shielding contact
Cable termination	tool-less with IDC contacts or preLink® IDC
Cable outer diameter	6.5 mm – 9.5 mm
Degree of protection	IP65/IP67
Temperature range	-40 °C ... +70 °C
Housing material	
plastic version	polycarbonate, UL 94 V0, black
metal version	
Standard	Zinc die-cast, powder coating grey
M version	Zinc die-cast, powder coating black

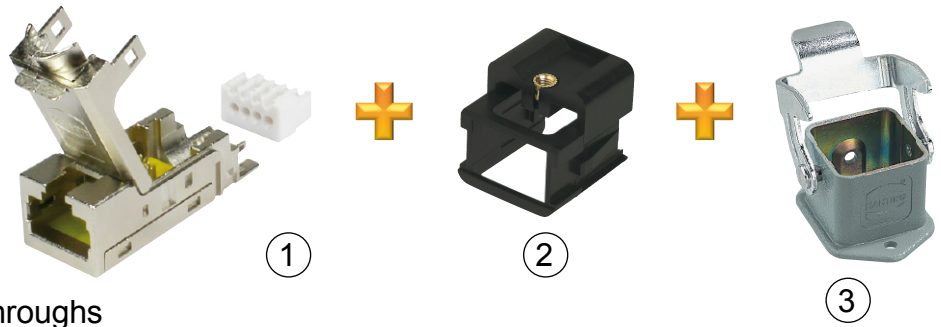

Han® 3 A RJ45 panel feed-throughs

Identification	Part number	Drawing	Dimensions in mm
Han® 3 A RJ45 female inserts 1			
Cat. 5, 4 poles, 10/100 Mbit/s IDC for AWG 24-22 solid and stranded	09 45 545 1120		
Cat. 6A, 8 poles, 10/100 Mbit/s and 1/10 Gbit/s IDC for AWG 28-24 solid and stranded	09 45 545 1561		
Cat. 6A, 8 poles, 10/100 Mbit/s and 1/10 Gbit/s IDC for AWG 24-22 solid and stranded	09 45 545 1562		
Cat. 6A, 4/8 poles, 10/100 Mbit/s and 1/10 Gbit/s preLink® IDC for AWG 23/22 or AWG 27/26 depending on the separately orderable preLink® terminal module (20 82 000 0001/20 82 000 0003)	20 82 001 0001		
Cat. 6, 8 poles, 10/100 Mbit/s and 1/10 Gbit/s RJ45 system cable jack on connector			
0.15 m	09 45 545 1500		
...	...		
10.0 m	09 45 545 1518		
Cat. 6, 8 poles, 10/100 Mbit/s and 1/10 Gbit/s RJ45 coupler with Han® 3 A adapter	09 45 200 1560		
Han® 3 A adapter for HIFF inserts 2	09 45 515 0024		

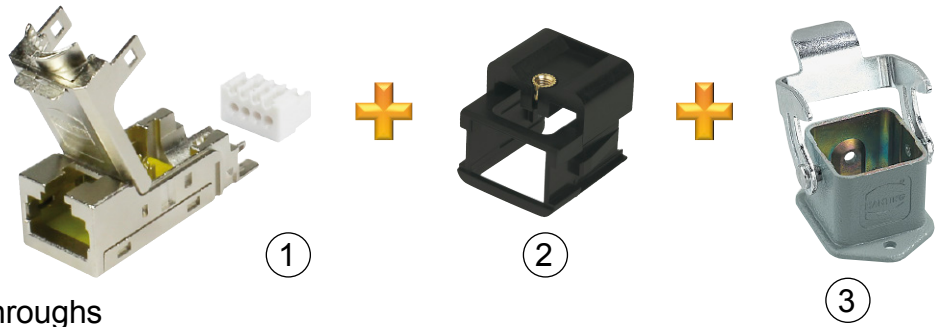

Han® 3 A RJ45 panel feed-throughs

Identification Part number Drawing Dimensions in mm

Han® housing

③

Housing bulkhead mounting

- metal, grey 09 20 003 0301
- metal, black 09 37 003 0301
- plastic, grey 09 20 003 0320
- plastic, black 09 20 003 0327
- metal, EMC 09 62 003 0301
- stainless steel 19 44 003 0301

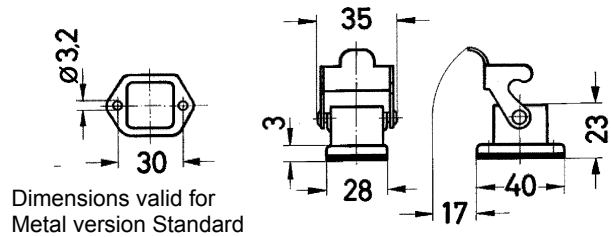

Housing bulkhead mounting with self-locking cap

- metal, grey 09 20 003 0306
- metal, black 09 37 003 0306
- metal, EMC 09 62 003 0306

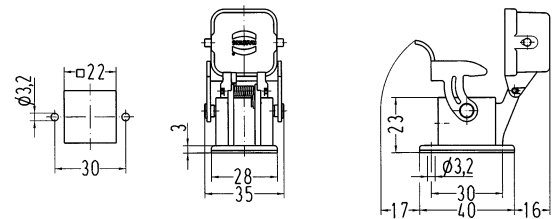

Housing cable-to-cable¹⁾²⁾

- metal, grey 19 20 003 1750
- metal, black 19 37 003 1750
- plastic, grey 19 20 003 0720
- plastic, black 19 20 003 0727
- metal, EMC 19 62 003 1750

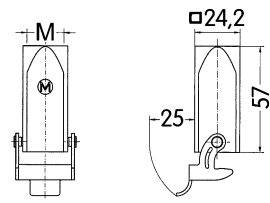

Housing surface mounting, flange closed¹⁾²⁾

- metal, grey 19 20 003 1252
- metal, black 19 37 003 1250
- plastic, grey 19 20 003 0220
- plastic, black 19 20 003 0227
- metal, EMC 19 62 003 1250
- stainless steel 19 44 003 1250

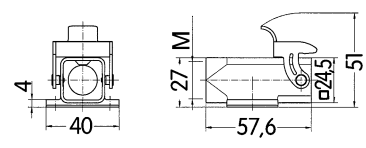

1) The small wall at the adapter 09 45 515 0024 must be removed
 2) M20 cable glands are listed at Han® 3 A connectors

Accessories

- coding pin set for 4 different codings 09 45 820 0000

1) Modification of the adapter 09 45 515 0024 needed
 2) M20 cable glands see page 03.77

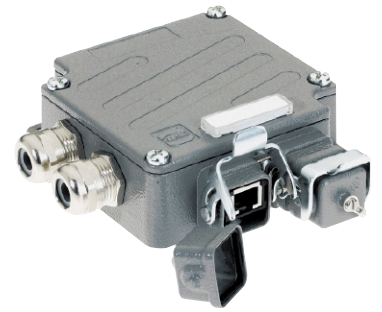

Han® 3 A RJ45
Metal Outlet, Cat. 5, 8 poles

Advantages

- Robust metal housing for use in harsh industrial environments
- Simple mounting
- Cable feeding optionally from the left or from the right side
- Lockable Han® 3 A connector ports
- PROFINET compliant

Technical characteristics

Number of ports, Copper/Termination	2 x Han® 3 A (V5) RJ45 (IP65/IP67)
Transmission performance	Category 5, Class D up to 100 MHz according to ISO/IEC 11 801, EN 50 173-1
Transmission rate	10/100 Mbit/s
Termination	LSA-PLUS module, terminating via LSA-PLUS tool
Strand diameter	AWG 26 ... 22 (0.35 mm ... 0.65 mm) solid and stranded
Strand insulation	0.7 mm ... 1.6 mm
Cable diameter	5 mm ... 9 mm
Shielding	Fully shielded, 360° shielding contact
Mounting	Wall mounting
Dimensions (H x W x D)	105 x 105 x 40.5 mm
Degree of protection	IP65/IP67
Operating temperature range	-40 °C ... +70 °C
Housing material	Aluminium, die-cast
Colour	Grey RAL 7037

Identification

Part number

Drawing

Dimensions in mm

Han® 3 A RJ45
Metal Outlet, Cat. 5

09 45 815 1100

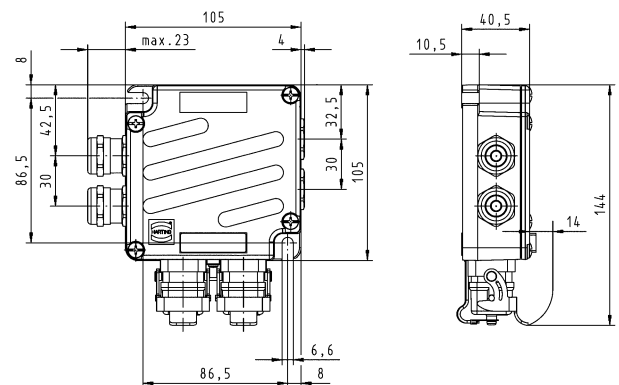

consisting of:
2-port metal housing with protection caps, cable glands and blanking piece
PCB module with LSA-PLUS strips
Label
Assembly instructions

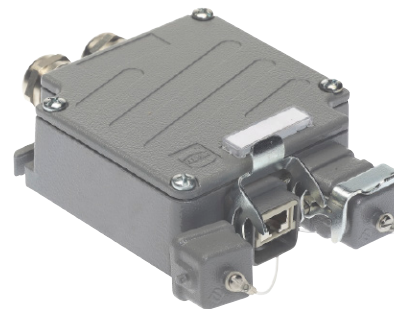

Han® 3 A
Metal Outlet, Cat. 6A, 8 pole

Advantages

- Simple mounting, fixing and earth connection both outside
- Fast termination of data cables due to Ha-VIS preLink® technology
- Structured cabling for industrial premises
- Mating face AIDA compliant, protection cover incl.
- PROFINET compatible

Technical characteristics

Number of ports, Copper/Termination	2 x Han® 3 A (V5) RJ45 (IP65/IP67)
Transmission performance	Category 6, Class E _A up to 500 MHz acc. to ISO/IEC 11801, EN 50173-1
Transmission rate	up to 10 Gbit/s
Termination	preLink® IDC
Wire gauge	AWG 24 ... 22 (0.25 mm ² ... 0.34 mm ²) solid and stranded
Strand diameter	Ø 1.3 mm ... 1.6 mm
Cable diameter	7.2 mm ... 8 mm
Shielding	Fully shielded 360° flexible shielding termination
Mounting	Wall mounting
Dimensions (H x W x D)	105 x 105 x 40.5 mm
Degree of protection	IP65/IP67
Operating temperature range	-40 °C ... +70 °C
Housing material	Aluminium, die-cast
Colour	Black

Connecting hardware

Identification	Part number	Drawing	Dimensions in mm
----------------	-------------	---------	------------------

preLink®
Han® 3 A Metal Outlet

20 82 102 0101

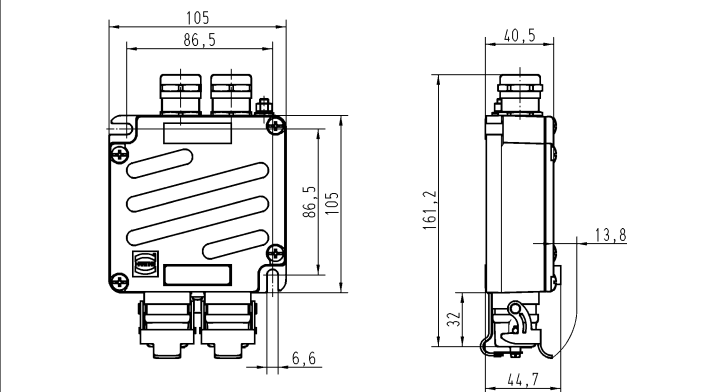

consists of:

- 1x Housing including protection covers
- 2x preLink® Set RJ45 jack AWG 22/23
- 2x Cable gland with slotted seal
- 1x Assembly instruction

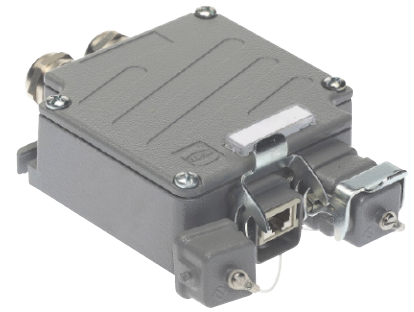

Han® 3 A RJ45
Metal Outlet, Cat. 6A, 8 pole

Advantages

- Robust metal housing for use in harsh industrial environments
- Simple mounting
- Cable feeding optionally from the left or from the right side
- Lockable Han® 3 A connector ports

Technical characteristics

Number of ports, Copper/Termination	2 x Han® 3 A (V5) RJ45 (IP65/IP67)
Transmission performance	Category 6A, Class E up to 500 MHz according to ISO/IEC 11 801, EN 50 173-1
Transmission rate	10/100 Mbit/s and 1/10 Gbit/s
Termination	IDC
Strand diameter	AWG 24 ... 22 solid and stranded
Strand insulation	0.7 mm ... 1.6 mm
Cable diameter	5 mm ... 9 mm
Shielding	Fully shielded, 360° shielding contact
Mounting	Wall mounting
Dimensions (H x W x D)	105 x 105 x 40.5 mm
Degree of protection	IP65/IP67
Operating temperature range	-40 °C ... +70 °C
Housing material	Aluminium, die-cast
Colour	Grey RAL 7037

Identification

Part number

Drawing

Dimensions in mm

Han® 3 A RJ45
Metal Outlet, Cat. 6A

09 45 815 1560

consisting of:
2-port metal housing with protection caps, cable glands and blanking plug,
2 x RJ45 cable jack 09 45 545 1562
Label
Assembly instructions

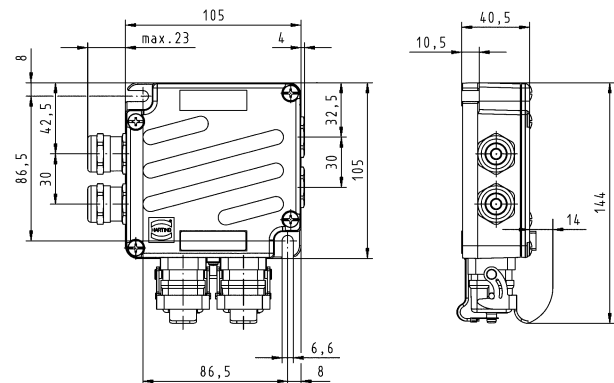

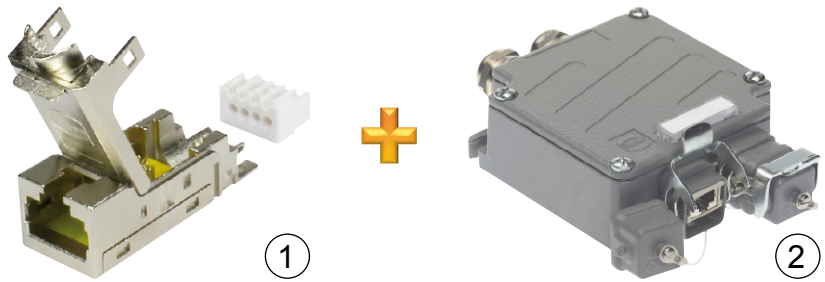

Han® 3 A RJ45 Metal Outlet

Identification	Part number	Drawing	Dimensions in mm
----------------	-------------	---------	------------------

Han® 3 A RJ45 junction box empty ①
 For fixture of 2x RJ45 female inserts

09 45 815 0000

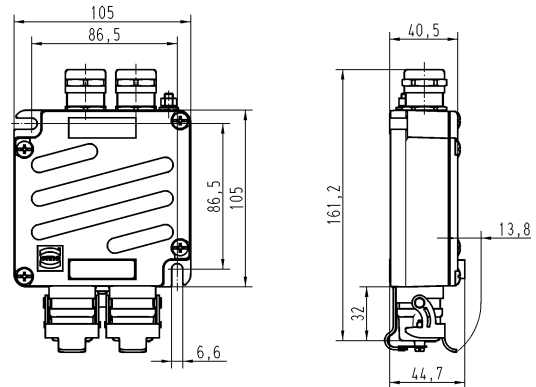

RJ45 female inserts ②

Cat. 5, 4 poles, 10/100 Mbit/s
 IDC for AWG 24-22 solid and stranded

09 45 545 1120

Cat. 6_A, 8 poles,
 10/100 Mbit/s and 1/10 Gbit/s
 IDC for AWG 28-24 solid and stranded

09 45 545 1561

Cat. 6_A, 8 poles,
 10/100 Mbit/s and 1/10 Gbit/s
 IDC for AWG 24-22 solid and stranded

09 45 545 1562

Cat. 6_A, 8 poles,
 10/100 Mbit/s and 1/10 Gbit/s
 preLink® IDC for AWG 23/22
 solid and stranded

20 82 001 0001

Cat. 6_A, 8 poles,
 10/100 Mbit/s and 1/10 Gbit/s
 preLink® IDC for AWG 27/26
 solid and stranded

20 82 001 0002

Cat. 6_A, 8 poles,
 10/100 Mbit/s and 1/10 Gbit/s
 preLink® IDC for AWG 23/22 or
 AWG 27/26 depending on the separately
 orderable preLink® terminal module
 (20 82 000 0001/20 82 000 0003)

20 82 000 0002

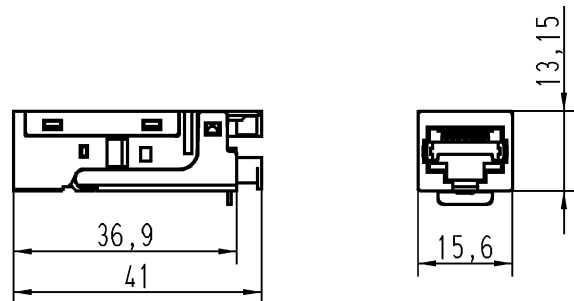



Han® 3 A RJ45, Hybrid

Advantages

• Type/Material	Han® 3 A RJ45 Hybrid (V5), plastic, metal
• Category	Cat. 5/Cat. 6/Cat. 6 _A
• Number of contacts	4/8 data + 4 power
• Termination	IDC
• Cable diameter	5 - 14 mm

Application

- Industrial cabling
- Within switch cabinets
- On machines and control units

Benefits

- Robust design
- Use on-site made possible via IP65/IP67 protection
- Easy handling for applications with additional power supply
- PROFINET compliant

Technical characteristics

Connector	
Degree of protection	IP65/IP67
Mating interface	RJ45, 4 poles acc. to IEC 60603-7 plus 4x power
Temperature range	-40 °C ... +70 °C
Housing material	
Plastic version	UL 94 V0, black
Metal version	Zinc die-cast, grey
Mating cycles	min. 500
Mounting	field-assembly
Data Cat. 5, 4 poles	
Transmission performance	Category 5, Class D up to 100 MHz acc. to ISO/IEC 11801, prEN 50 173-1
Transmission rate	10/100 Mbit/s
Cable diameter	
stranded	AWG 24/7 - AWG 22/7
solid	AWG 23/1 - AWG 22/1
Data Cat. 6, 8 poles	
Transmission performance	Category 6, Class E _A up to 500 MHz acc. to ISO/IEC 11801, prEN 50 173-1
Transmission rate	10/100 Mbit/s / 1 Gbit/s
Cable diameter	
stranded / solid	AWG 27 - AWG 22
Both, data Cat. 5 and Cat. 6	
Shielding	fully shielded, 360° shielding contact
Cable outer diameter	6 mm – 12 mm
Power	
Number of contacts	4 for cable diameter 1.5 mm ² stranded
Working voltage	48 V / DC
Working current	16 A, see current carrying capacity
	UL approved (E102079)
Panel feed-through	
Mating interface extern:	RJ45 female acc. to IEC 60603-7 plus 4 x power
Mating interface intern:	RJ45 female acc. to IEC 60603-7 4 x power via cable cage clamp 1.5 mm ²

Han® 3 A RJ45 Hybrid IP65/IP67 connectors



Han® 3 A RJ45, Hybrid

Identification	Part number	Drawing	Dimensions in mm
<p>Connector, Cat. 5, 4 + 4 poles (IDC termination for RJ45 insert)</p> <p>Plastic version, black</p> <p>Metal version Standard, grey</p>	<p>09 45 125 1300</p> <p>10 12 005 2001</p>		
<p>Connector, Cat. 6, 8 + 4 poles (IDC termination for RJ45 insert)</p> <p>Plastic version, black</p> <p>Metal version Standard, grey</p>	<p>09 45 125 1760</p> <p>09 45 115 1760</p>		
<p>Connector insert for Han® 3 A housings</p>	09 45 100 1760		
<p>Connector, Cat. 6, 8 + 4 poles (with piercing connection AWG 28/7 - 24/7)</p> <p>Plastic version, black</p> <p>Metal version Standard, grey</p> <p>Connector insert for Han® 3 A housings</p> <p>suitable assembly tool</p>	<p>09 45 125 1720</p> <p>09 45 115 1720</p> <p>09 45 100 1720</p> <p>09 45 800 0520</p>		
<p>Protection cover for connector IP65/IP67 without seal</p> <p>Plastic version, black</p> <p>Metal version Standard, grey</p> <p>Metal version M</p>	<p>09 20 003 5442</p> <p>09 20 003 5422</p> <p>09 37 003 5402</p>		

Dimensions valid for plastic version



Han® 3 A RJ45 Hybrid connectors

Identification	Part number	Drawing	Dimensions in mm
Han® 3 A RJ45 connector inserts ① Cat. 6, 8 poles, 10/100 Mbit/s and 1/10 Gbit/s IDC for AWG 27-22 solid and stranded Cat. 6A, 8 poles, 10/100 Mbit/s and 1/10 Gbit/s piercing termination for AWG 28-26 stranded	09 45 100 1760 09 45 100 1720		
Han® 3 A connector housing M20 (with glued seal) ② straight cable entry: – metal, grey – metal, black – plastic, grey – plastic, black – metal, EMC – stainless steel angled cable entry: – plastic, grey – plastic, black	19 20 003 1443 19 37 003 1443 19 20 003 0423 19 20 003 0426 19 62 003 1443 19 44 003 1443 19 20 003 0623 19 20 003 0626		
M20 cable glands ③ metal: – 5 ... 9 mm – 5 ... 12 mm – 6 ... 12 mm – 10 ... 14 mm plastic, grey: – 5 ... 9 mm – 6 ... 12 mm – 10 ... 14 mm plastic, black: – 5 ... 9 mm – 6 ... 12 mm – 10 ... 14 mm metal, EMC version: – 6.5 ... 9.5 mm – 4.0 ... 6.5 mm – 7.0 ... 10.5 mm – 9.0 ... 13.0 mm stainless steel: – 6 ... 13 mm	19 00 000 5080 19 00 000 5081 19 00 000 5082 19 00 000 5084 19 00 000 5180 19 00 000 5182 19 00 000 5184 19 00 000 5181 19 00 000 5183 19 00 000 5185 19 62 000 5080 19 62 000 5081 19 62 000 5082 19 62 000 5084 19 44 000 5082		



PROFINET Type B cable, Hybrid Industrial Cat. 5 Hybrid cable, 4-wire + 4x Power to make up Hybrid system cables

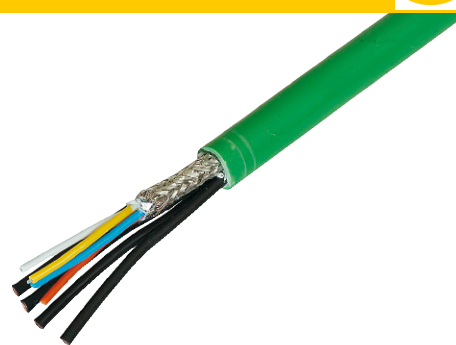

Advantages

- Robust design for industrial environment
- PROFINET-conform
- Additional power supply
- Hybrid Cat. 5 cable, 4-wire + 4x Power

Technical characteristics

Cable construction	Star quad + 4 Power cables, double shielded
Core structure	4 x AWG 22/7 + 4 x 1.5 mm ² (conductor 84 x 0.15 mm ²)
Sheath material	FRNC, halogen free
Cable outer diameter	9.7 mm
Transmission performance	Category 5, Class D up to 100 MHz acc. to ISO/IEC 11801, EN 50 173-1
Transmission rate	10/100 Mbit/s
Shielding	Shielding foil and shielding braid
Temperature range	-20 °C ... +70 °C
Colour	Green

Identification

PROFINET Type B cable, Hybrid Industrial Cat. 5 Hybrid cable, 4-wire + 4x Power

- 10 m ring
- 20 m ring
- 50 m ring
- 100 m ring
- 500 m reel

Part number

- 09 45 600 0310
- 09 45 600 0330
- 09 45 600 0340
- 09 45 600 0300
- 09 45 600 0320

Drawing

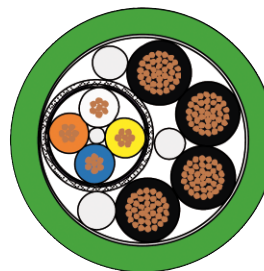

Dimensions in mm



Industrial Cat. 6 Hybrid
Installation cable, 8-wire

Advantages

- Robust design for industrial environment
- PROFINET-conform
- Additional power supply
- Hybrid Cat. 6 cable, 4-wire + 4x Power

Technical characteristics

Cable structure	4 x 2, Twisted Pair, shielded, PIMF 4 power cores
Core structure	4 x 2 x AWG 26/7, stranded 4x 84 * 0.15 mm (cord 1.5 mm ²), stranded
Sheath material	PUR
Cable sheath diameter	10 ... 10.6 mm
Transmission performance	Category 6, Class E up to 250 MHz according to ISO/IEC 11801, EN 50 173-1
Transmission rate	10/100/1000 Mbit/s
Shielding	Paired shielded with additional cable shield
Operating temperature range	-20 °C ... +80 °C
Colour	Black

Identification

Industrial Cat. 6 Hybrid
installation cable,
8-wire
PUR

20 m ring
50 m ring
100 m drum

Part number

09 45 600 0332
09 45 600 0342
09 45 600 0302

Drawing



Dimensions in mm



Han® 3 A, Hybrid, panel feed-throughs

Identification	Part number	Drawing	Dimensions in mm
<p>Panel feed-through set</p> <ul style="list-style-type: none"> Plastic version, black, Cat. 6 Metal version Standard, grey, Cat. 6 Metal version M, black, Cat. 6 Metal version EMC, Cat. 6 Metal version EMC, Cat. 6 with anti-interference capacitor 	<ul style="list-style-type: none"> 09 45 225 1760 09 45 215 1760 09 45 215 1761 09 45 215 1762 09 45 215 1765 		
<p>Protection cover for panel feed-through IP65/IP67</p> <ul style="list-style-type: none"> Plastic version, black Metal version Standard, grey Metal version M, black 	<ul style="list-style-type: none"> 09 20 003 5449 09 20 003 5425 09 37 003 5405 		

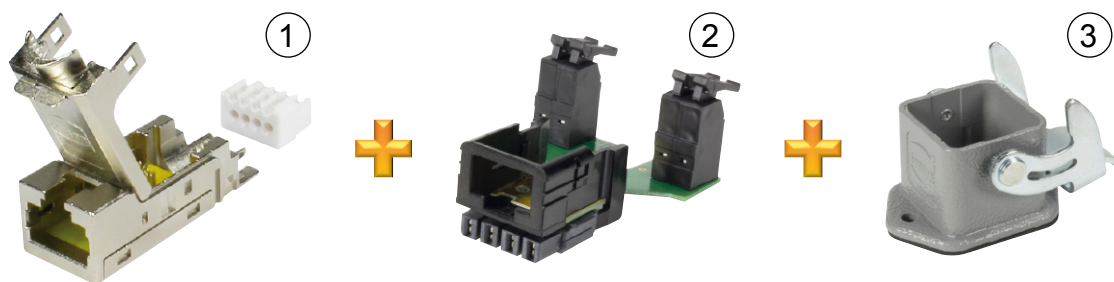

Han® 3 A RJ45 Hybrid IP65/IP67 connectors

Identification	Part number	Drawing	Dimensions in mm
Han® 3 A RJ45 female inserts ① Cat. 5, 4 poles, 10/100 Mbit/s IDC for AWG 24-22 solid and stranded Cat. 6, 8 poles, 10/100 Mbit/s and 1/10 Gbit/s IDC for AWG 28-24 solid and stranded Cat. 6, 8 poles, 10/100 Mbit/s and 1/10 Gbit/s IDC for AWG 24-22 solid and stranded Cat. 6 _A , 4/8 poles, 10/100 Mbit/s and 1/10 Gbit/s preLink® IDC for AWG 23/22 or AWG 27/26 depending on the separately orderable preLink® terminal module (20 82 000 0001/20 82 000 0003) Cat. 6, 8 poles, 10/100 Mbit/s and 1/10 Gbit/s RJ45 system cable jack on connector	09 45 545 1120 09 45 545 1561 09 45 545 1562 20 82 001 0001 09 45 545 1500 0.15 m ... 10.0 m		
Han® 3 A RJ45 Hybrid adapter for HIFF inserts with power modules ②	09 45 200 1760		
Han® housing ③ Housing bulkhead mounting: – metal, grey – metal, black – metal, EMC	10 12 005 1004 09 45 515 0027 09 45 515 0028	<p> ① HAN 3A Lever MB 09 00 080 5242 ② IP67 Hybrid receptacle Housing MB 09 45 08 96 </p>	
Han® 3 A RJ45 Hybrid adapter for HIFF inserts with power modules and black Han® 3 A housing ② + ③	09 45 225 1761		

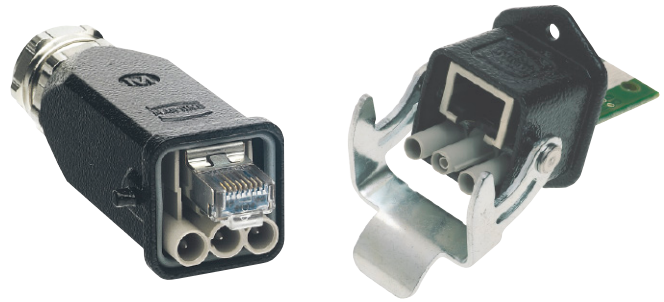

Han® 3 A RJ45 Hybrid

Advantages

- RJ45 Ethernet-Data connector suitable for industry with Power contacts for hybrid applications
- Field-assembly with mounting tool
- Category of transmission Cat. 5
- Compact design and very robust housing
- Suitable for termination with solid and stranded cables
- Protection against direct contact on cable and device side according to EN 60 529

Technical characteristics

Degree of protection	IP65/IP67
Mating interface	RJ45, 8 poles acc. to IEC 60 603-7 plus 3x power
Temperature range	-40 °C ... +70 °C
Housing material	Zinc die-cast, powder coating black
Data	
Transmission performance	Category 5, Class D up to 100 MHz acc. to ISO/IEC 11 801, EN 50 173-1
Transmission rate	10/100/1000 Mbit/s
Shielding	fully shielded, 360° shielding contact
Cable diameter stranded	AWG 28/7 - AWG 24/7
Power	
Number of contacts	3 (AC: L1, PE, N/DC: V+, GND, V-)
Working voltage	300 V AC/DC
Working current	12 A @ 70 °C (see current carrying capacity Han D® contacts)
Cable diameter	2.5 mm ²

Connecting hardware

Identification	Part number	Drawing	Dimensions in mm
Components device side incl. 3x Han D® female contacts			
AC version	09 57 368 0512 000		
DC version	09 57 368 0513 000		
Cable side Connector incl. 3x Han D® male contacts			
AC version	09 57 308 0500 000		
DC version	09 57 308 0501 000		
suitable assembly tool	09 45 800 0520		



Hybrid cable assembly

Identification	Part number	Drawing	Dimensions in mm
<p>Hybrid cable, double ended, 4 x 2 x AWG 26/7 + 3 x 2.5 mm²</p> <p>Length: 1 m AC version DC version</p> <p>Length: 5 m AC version DC version</p> <p>Length: 10 m AC version DC version</p> <p>Length: 20 m AC version DC version</p>	<p>33 57 211 0010 001 33 57 211 0010 002</p> <p>33 57 211 0050 001 33 57 211 0050 002</p> <p>33 57 211 0100 001 33 57 211 0100 002</p> <p>33 57 211 0200 001 33 57 211 0200 002</p>	<p>double ended</p> <p>a = length</p>	
<p>Hybrid cable, single ended, 4 x 2 x AWG 26/7 + 3 x 2.5 mm²</p> <p>Length: 1 m AC version DC version</p> <p>Length: 5 m AC version DC version</p> <p>Length: 10 m AC version DC version</p> <p>Length: 20 m AC version DC version</p>	<p>33 57 111 0010 002 33 57 111 0010 001</p> <p>33 57 111 0050 002 33 57 111 0050 001</p> <p>33 57 111 0100 002 33 57 111 0100 001</p> <p>33 57 111 0200 002 33 57 111 0200 001</p>	<p>Protection level: IP65/IP67</p> <p>Data part: Transmission properties in accordance with ISO/IEC 11801: Class D</p> <p>single ended</p> <p>a = length</p>	

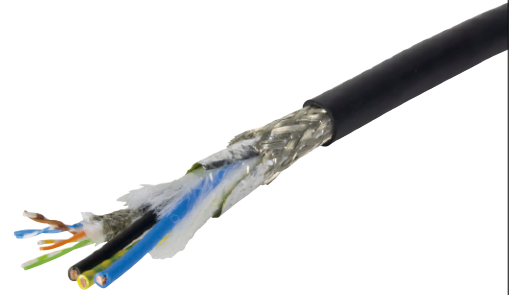

Industrial Cat. 5 hybrid cable,
8-wire + 3 x 2.5 mm², PVC

Features

- Sheath material PVC
- Category Cat. 5
- Number of wires 8 + 3 x 2.5 mm²
- Wire diameter 11.9 mm

Application

- Suitable for industrial communications for outdoor applications
- Usable for transfer rate up to 1 Gigabit Ethernet 1 GBase-T acc. to IEEE 802.3ab

Benefits

- Robust design suitable for industry
- Good EMC characteristics

Technical characteristics

- Cable structure 4 x 2, Twisted Pair, shielded, SF/UTP plus 3 x 2.5 mm²
- Core structure 4 x 2 x AWG 26/7, stranded 3 x 2.5 mm²
- Sheath material PVC
- Cable sheath diameter 11.9 ± 0.4 mm
- Transmission performance Category 5, Class D up to 100 MHz acc. to EN 50288-2-2:2004
- Transmission rate 10/100 Mbit/s
- Shielding Aluminium foil overlapped tinned copper braid
- Operating temperature range
 fix operation -40 °C ... +80 °C
 flexible operation -40 °C ... +80 °C
- Colour Black

Identification	Part number	Drawing	Dimensions in mm
Industrial Cat. 5 hybrid cable, 8-wire + 3 x 2.5 mm ² PVC			
	10 m ring	33 57 851 0100 001	
	20 m ring	33 57 851 0200 001	
	30 m ring	33 57 851 0300 001	
	100 m reel	33 57 851 1000 001	
500 m reel	33 57 851 5000 001		

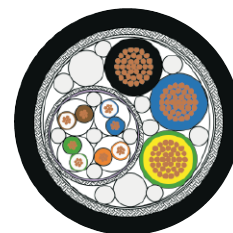



Han® 3 A LC duplex Hybrid

Advantages

- Small form factor (compared to SC and ST®)
- Compact, space-saving Design
- Combined to only one LWL-module for high mechanical load
- High packing density
- A & B parts identification according to TIA 568 standard

Technical characteristics

Degree of protection	IP65/IP67
Temperature range	-40 °C ... +70 °C
Data	
Mating module	LC duplex (2 fibres)
Cable diameter	6.0 ... 9.0 mm
Power	
Number of contacts	3 (AC: L1, PE, N/DC: V+, GND, V-)
Working voltage	300 V AC/DC
Working current	12 A @ 70°C
Housing material	Aluminium die-cast, black

Identification	Part number	Drawing	Dimensions in mm
Components device side			
Power: 3x Han D® male contacts			
Data: Multi mode GOF	AC DC	09 57 568 0500 000 09 57 568 0510 000	
Data: Single mode GOF	AC DC	09 57 568 0501 000 09 57 568 0511 000	
Connector			
Power: 3x Han D® female contacts			
Data: Multi mode GOF	AC DC	09 57 508 0500 000 09 57 508 0510 000	
Data: Single mode GOF	AC DC	09 57 508 0501 000 09 57 508 0511 000	

Description of the Han-Modular® system

The Han-Modular® series is designed for combining different transmission media in one connector. The multifaceted system of inserts, contacts, frames, hoods and housings as well as accessories fulfils individual customer requirements. The customer can choose between more than 50 different modules. These are suitable for different transmission media and cover various termination techniques.

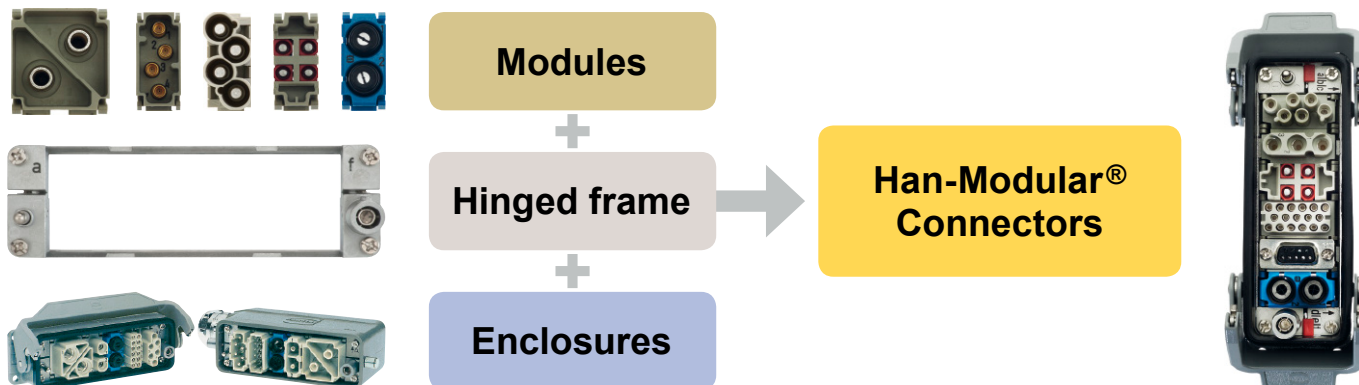

The patented Han-Modular® hinged frame enables the configuration of all modules in the well-accepted Han® hoods and housings. Further additional solutions are available, e.g. suitable docking frames for drawer units. Individual customer requirements can be realised by means of the Han-Modular® series. Combining various transmission media in one single connector results in lower expenditures in installation time and production downtime. Space savings and cost savings are further benefits. The easy extension possibilities secure the ideal solution for an actual as well as future safe design.

System description

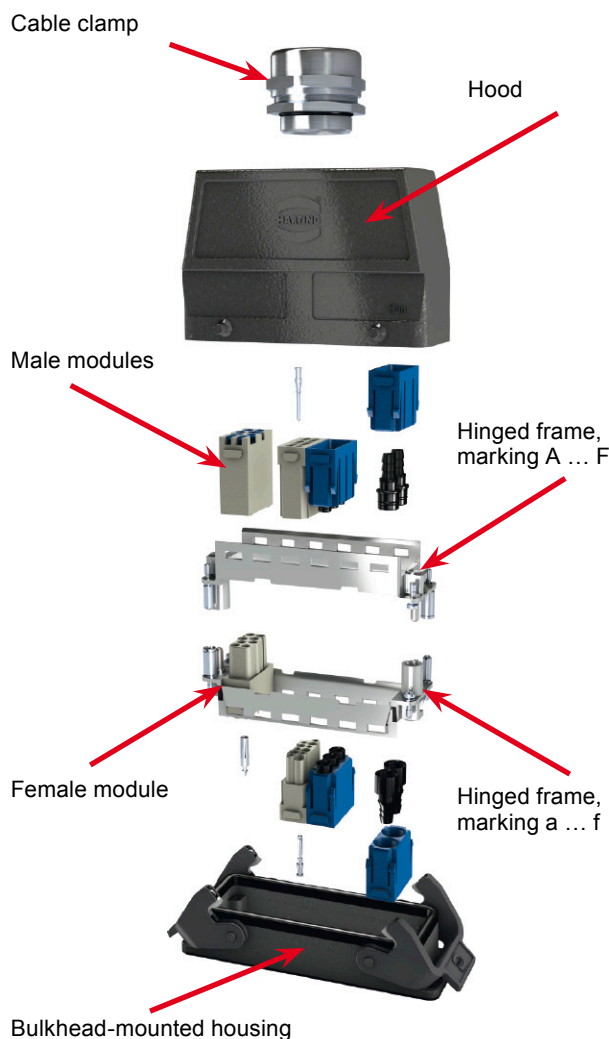

Connecting hardware

Number of contacts

8

50 V
1 A

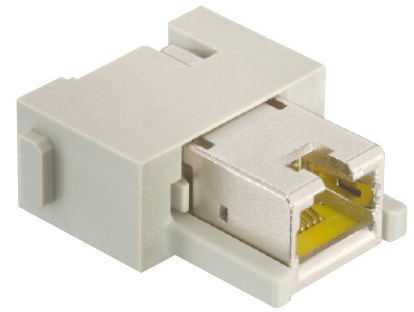

Features

- Single module with standard shielded RJ45 plug and jack
- Cat. 6 for all data pairs (all 8 pins)
- RoHS compliant
- Patch cables are assembled/removed without tools

Technical characteristics

Contacts	8
Electrical data acc. to IEC 61984	1 A 50 V 0.8 kV 3
Rated current	1 A
Rated voltage	50 V
Rated impulse voltage	0.8 kV
Pollution degree	3
Rated voltage acc. to UL	30 V
Insulation resistance	≥ 10 ¹⁰ Ohm
Limiting temperatures	-40 °C ... 70 °C
Flammability (insert) acc. to UL 94	V 0
Mating cycles	≥ 500
Material (insert)	polycarbonate
Colour (insert)	RAL 7032 (light grey)
Transmission characteristics	Category 6, Class E up to 250 MHz, according to ISO/IEC 11801 and EN 50 173-1
Data rate copper	10 Mbit/s, 100 Mbit/s, 1000 Mbit/s, 10000 Mbit/s

Specifications / Approvals

IEC 60664-1
IEC 61984



Identification

Part number

Drawing

Dimensions in mm

Han-Modular®,
Han® RJ45 module
Gender changer,
for patch cable, Cat. 6

09 14 001 4721

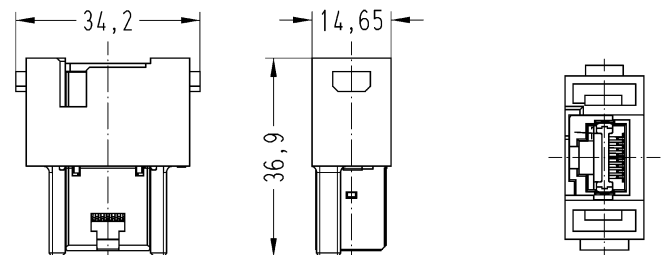

Features

- Compatible with Han® RJ45 male module (e.g. 09 14 001 4623)
- Category of transmission Cat. 6
- Field-assembly with HARAX®
- 360° shielding

Technical characteristics

Number of contacts	8
Transmission	Category 6, Class E _A , suitable for 1/10 Gigabit Ethernet
Transmission performance	Category 6, Class E _A up to 500 MHz acc. to ISO/IEC 11801, EN 50 173-1
Transmission rate	10/100 Mbit/s and 1/10 Gbit/s
Mounting	Field-assembly
Cable termination	with IDC-contacts, without tools
Connectable cables	
- Conductor cross section	AWG 27 ... AWG 24 AWG 24 ... AWG 22
- Conductor diameter	max. 1.6 mm (incl. insulation)
- Cable diameter	5 ... 9 mm
Mating cycles	≥ 500
Temperature range	-40 °C ... +70 °C
Housing material	Zinc die-cast, nickel-plated

Han® RJ45 Module with preLink® and IDC termination

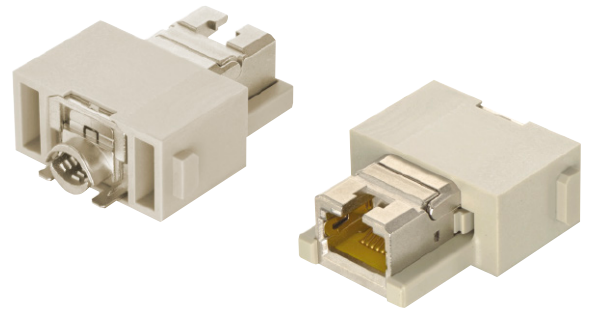

Identification	Part number	Drawing	Dimensions in mm
----------------	-------------	---------	------------------

Han® RJ45 Module, female
RJ45 cable jack, order separately

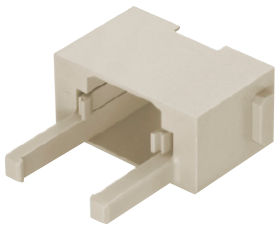

09 14 001 4722

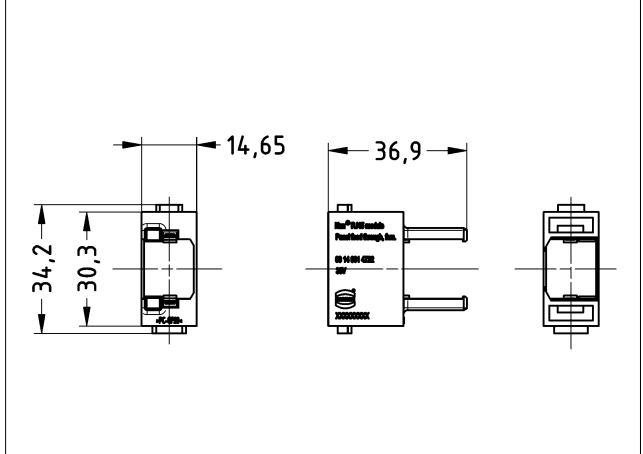

Han® RJ45 cable jack

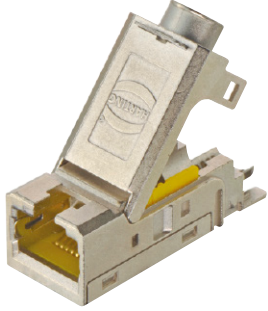

8-poles, Cat. 6, preLink® termination
AWG 23 - 22

8-poles, Cat. 6, IDC termination AWG 27 - 24

8-poles, Cat. 6, IDC termination AWG 24 - 22

4-poles, Cat. 5, IDC termination AWG 23 - 22

09 14 008 4720

09 14 545 1561

09 14 545 1562

09 14 545 1120

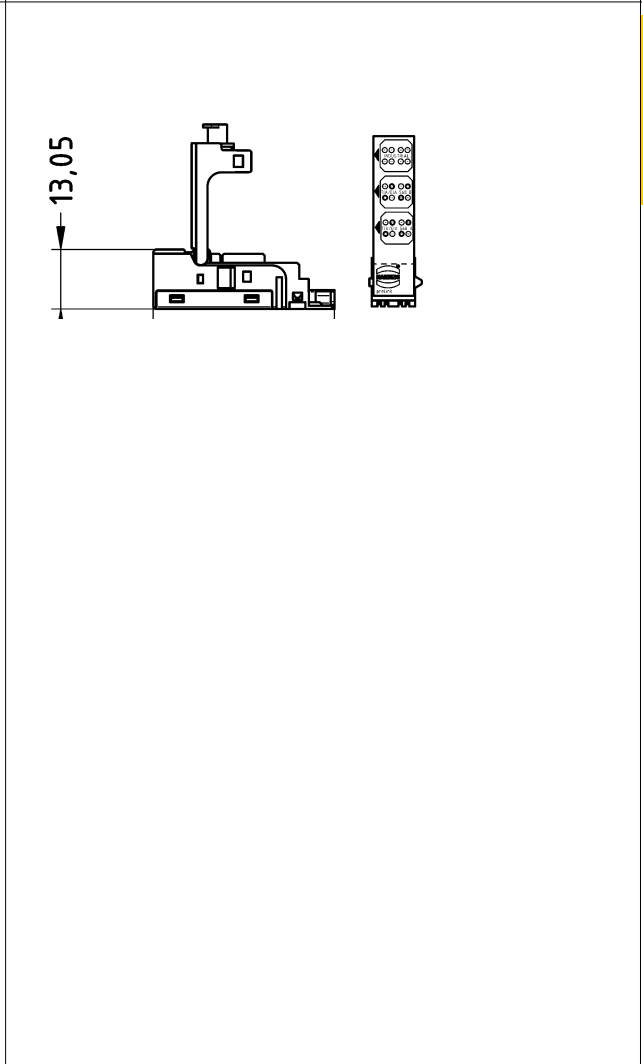

Number of contacts

4, 8

50 V
1 A

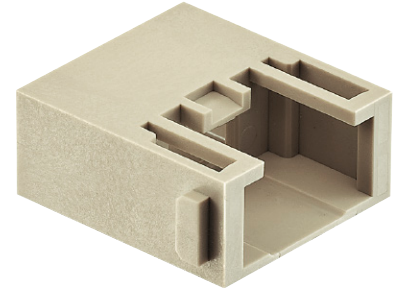

Features

- Single module with standard shielded RJ45 plug and jack
- The RJ45 inserts are protected by a reliable plastic insulator
- 360° shielded contact
- Field assembly without tools possible by means of *HARAX®* rapid termination in IDC technology
- Gigalink: Field assembly by means of piercing contacts
- Suitable for termination of massive and flexible wires
- Gigalink: Suitable for termination of flexible wires

Technical characteristics

Contacts	8, 4
Electrical data acc. to IEC 61984	1 A 50 V 0.8 kV 3
Rated current	1 A
Rated voltage	50 V
Rated impulse voltage	0.8 kV
Pollution degree	3
Rated voltage acc. to UL	30 V
Insulation resistance	≥ 10 ¹⁰ Ohm
Limiting temperatures	-40 °C ... 70 °C
Flammability (insert) acc. to UL 94	V 0
Mating cycles	≥ 500
Material (insert)	polycarbonate, polyamide
Colour (insert)	RAL 7032 (light grey)
Transmission characteristics	Category 6A, Class E _A up to 500 MHz, acc. to ISO/IEC 11801 and EN 50173-1, Category 5, Class D up to 100 MHz, acc. to ISO/IEC 11801 and EN 50173-1, Category 6, Class E up to 250 MHz, acc. to ISO/IEC 11801 and EN 50173-1
Data rate copper	10 Mbit/s, 100 Mbit/s, 1000 Mbit/s, 10000 Mbit/s

Specifications / Approvals

IEC 60664-1
IEC 61984
IEC 60603-7



Identification

Part number

Drawing

Dimensions in mm

Han-Modular®,
Han® RJ45 module
for adapter

09 14 001 4623

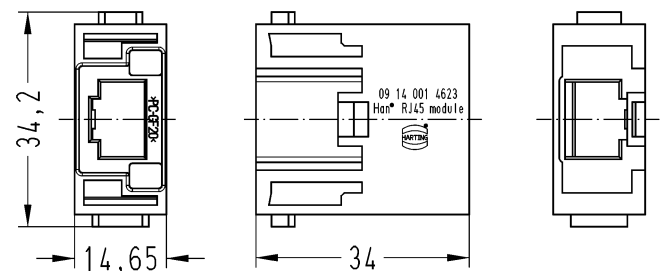

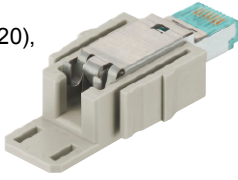
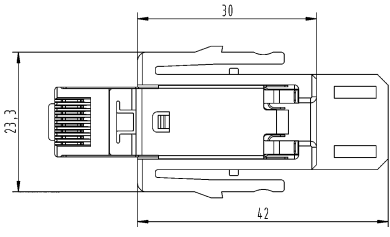
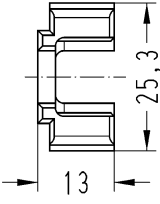
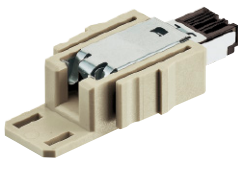
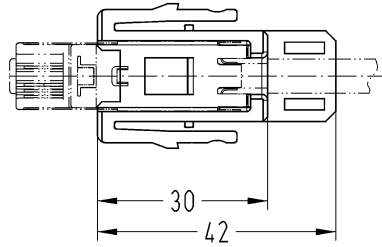
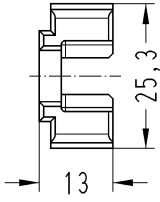
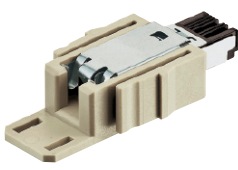
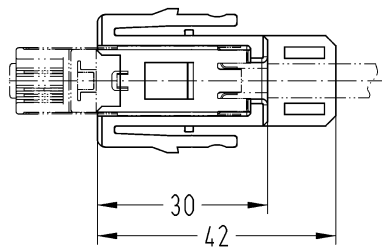
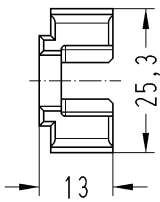
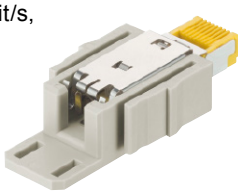
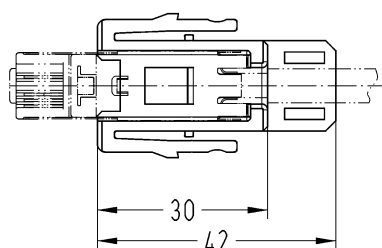
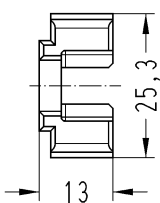
Identification	Part number	Drawing	Dimensions in mm
<p>Han-Modular®, Han® RJ Industrial adapter RJ Industrial RJ45 Gigalink connector set, AWG 28/7 ... 24/7, 10 Mbit/s, 100 Mbit/s, 1000 Mbit/s, 10000 Mbit/s, piercing contacts (use tool: 09 45 800 0520), Cat. 6A</p> 	09 45 400 1520	 <p>Wire outside diameter ≤ 1.05 mm</p>	
<p>Han-Modular®, Han® RJ Industrial adapter RJ Industrial RJ45 connector set, AWG 24 ... 22, 10 Mbit/s, 100 Mbit/s, IDC contacts, Cat. 5</p> 	09 45 400 1100	 <p>Wire outside diameter ≤ 1.6 mm</p>	
<p>Han-Modular®, Han® RJ Industrial adapter RJ Industrial RJ45 connector set, AWG 26, 10 Mbit/s, 100 Mbit/s, IDC contacts, Cat. 5</p> 	09 45 400 1109	 <p>Wire outside diameter ≤ 1.6 mm</p>	
<p>Han-Modular®, Han® RJ Industrial adapter RJ Industrial RJ45 connector set, AWG 27 ... 22, 10 Mbit/s, 100 Mbit/s, 1000 Mbit/s, 10000 Mbit/s, IDC contacts, Cat. 6</p> 	09 45 400 1560	 <p>Wire outside diameter ≤ 1.5 mm</p>	



har-port RJ45 coupler

Advantages

- Compact and well-shaped service interface in a timeless attractive design
- Easy mounting
- Transmission Category 6_A, performance class E_A, suitable for 1/10 Gigabit Ethernet
- Compact and robust design
- Practical accessories

Technical characteristics

Number of ports	2x RJ45
Transmission performance	Category 6 _A , Class E _A acc. to ISO/IEC 11801, EN 50 173-1
Transmission rate	10/100 Mbit/s and 1/10 Gbit/s
Shielding	Fully shielded, 360° shielding contact
Mounting	Screwable in cover plates
Degree of protection	IP20
Mating cycles	min. 750
Temperature range	-25 °C ... +70 °C
Housing material	Polyamide

Connecting hardware

Identification	Part number		Drawing	Dimensions in mm
	silver	black		
har-port RJ45 Cat. 6 coupler	09 45 452 1560	09 45 452 1561		
har-port RJ45 Cat. 6 coupler with cable				
Length:				
0.15 m	09 45 452 1500	09 45 452 1530		
0.2 m	09 45 452 1501	09 45 452 1531		
0.3 m	09 45 452 1502	09 45 452 1532		
0.5 m	09 45 452 1504	09 45 452 1534		
0.7 m	09 45 452 1506	09 45 452 1536		
1.0 m	09 45 452 1509	09 45 452 1539		
1.5 m	09 45 452 1510	09 45 452 1540		
2.0 m	09 45 452 1511	09 45 452 1541		
2.5 m	09 45 452 1512	09 45 452 1542		
3.0 m	09 45 452 1513	09 45 452 1543		
3.5 m	09 45 452 1514	09 45 452 1544		
4.0 m	09 45 452 1515	09 45 452 1545		
5.0 m	09 45 452 1516	09 45 452 1546		
7.5 m	09 45 452 1517	09 45 452 1547		
10.0 m	09 45 452 1518	09 45 452 1548		



har-port RJ45 coupler

Advantages

- Type/Material RJ45
- Category 5/6_A
- Number of contacts 4/8
- Termination IDC
- Cable diameter 5 - 9 mm

Application

- For an easy access at devices, control cabinets or other distributors
- For diagnostic, maintenance and process data monitoring

Benefits

- Compact and well-shaped service interface in a timeless attractive design
- Easy mounting
- Transmission Category 6_A, performance class E_A, suitable for 1/10 Gigabit Ethernet
- Compact and robust design
- Practical accessories

Technical characteristics

Connector type	RJ45
Number of contacts	4/8
Transmission performance	Category 5/6 _A Class D up to 100 MHz acc. to ISO/IEC 11801, EN 50 173-1
Transmission rate	10/100 Mbit/s 1/ 10 Gbit/s
Shielding	fully shielded, 360° shielding contact
Cable termination	tool-less with IDC contacts
Conductor cross section	stranded / solid
Cable outer diameter	6 mm – 9 mm
Degree of protection	IP20
Temperature range	-40 °C ... +70 °C
Housing material	Polyamide

Identification

har-port panel feed-throughs

to build-up customer-specific Ethernet interfaces

- silver
- black
- stainless steel

①

Part number

- 09 45 452 0000
- 09 45 452 0001
- 09 45 452 0002

Drawing

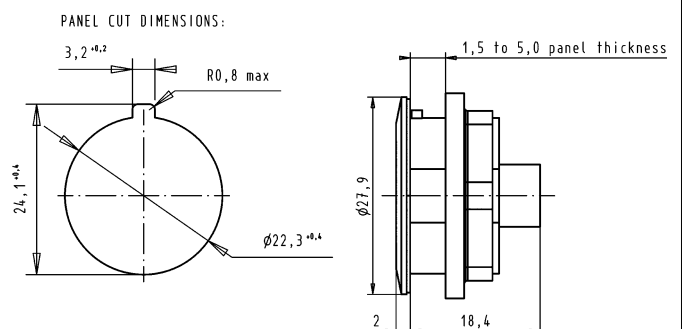

Dimensions in mm



har-port RJ45 coupler

Identification Part number Drawing Dimensions in mm

RJ45 female inserts

②

Cat. 5, 4 poles,
10/100 Mbit/s
IDC for AWG 24-22 solid and stranded

09 45 545 1120

Cat. 6_A, 8 poles,
10/100 Mbit/s and 1/10 Gbit/s
IDC for AWG 28-24 solid and stranded

09 45 545 1561

Cat. 6_A, 8 poles,
10/100 Mbit/s
and 1/10 Gbit/s
IDC for AWG 24-22
solid and stranded

09 45 545 1562

Cat. 6_A, 8 poles,
10/100 Mbit/s and 1/10 Gbit/s
preLink® IDC for AWG 23/22
solid and stranded

20 82 001 0001

Cat. 6_A, 8 poles,
10/100 Mbit/s and 1/10 Gbit/s
preLink® IDC for AWG 27/26
solid and stranded

20 82 001 0002

Cat. 6_A, 8 poles,
10/100 Mbit/s and 1/10 Gbit/s
preLink® IDC for AWG 23/22 or
AWG 27/26 depending on the separately
orderable preLink® terminal module
(20 82 000 0001/20 82 000 0003)

20 82 000 0002

preLink® terminal module gelb
für AWG 23/22 solid and stranded

20 82 000 0001

preLink® terminal module weiß
für AWG 27/26 solid and stranded

20 82 000 0003

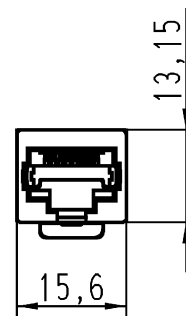
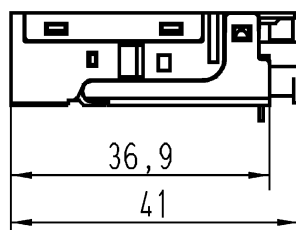

Accessories

Unlocking tool for opening of the jacks

20 82 000 9916

preLink® assembly tool

20 82 000 9901

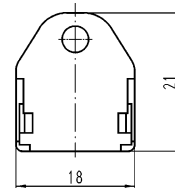



har-port USB coupler

Advantages

- Compact and well-shaped service interface in a timeless attractive design
- Easy mounting
- Compact and robust design
- Practical accessories

Technical characteristics

Mounting	Screwable in cover plates (thread M22 x 1)
Degree of protection	IP20
Mating cycles	min. 1500
Temperature range	-25 °C ... +70 °C
Housing material	Polyamide

Identification	Part number		Drawing	Dimensions in mm
	silver	black		
har-port USB 2.0 coupler Type A jack – Type A jack	09 45 452 1901	09 45 452 1903		
har-port USB 3.0 coupler Type A jack – Type A jack	09 45 452 1902	09 45 452 1904		
har-port USB 2.0 coupler with cable Type A jack – Type A connector Length: 0.15 m 0.4 m 0.5 m 1.0 m 1.5 m 2.0 m 3.0 m 4.0 m 5.0 m	09 45 452 1927 09 45 452 1928 09 45 452 1920 09 45 452 1921 09 45 452 1922 09 45 452 1923 09 45 452 1924 09 45 452 1926 09 45 452 1925	09 45 452 1960 09 45 452 1961 09 45 452 1962 09 45 452 1963 09 45 452 1964 09 45 452 1965		
Type B jack – Type B connector Length: 0.5 m 1.0 m 1.5 m 2.0 m 3.0 m 5.0 m	09 45 452 1910 09 45 452 1911 09 45 452 1912 09 45 452 1913 09 45 452 1914 09 45 452 1915			

har-port USB coupler

Identification	Part number		Drawing	Dimensions in mm
	silver	black		

har-port USB 2.0 coupler

2 x Type A jack –
Type A connector

Length:	Part number
0.5 m	09 45 452 1950
1.0 m	09 45 452 1951
1.5 m	09 45 452 1952
2.0 m	09 45 452 1953
3.0 m	09 45 452 1954
5.0 m	09 45 452 1955

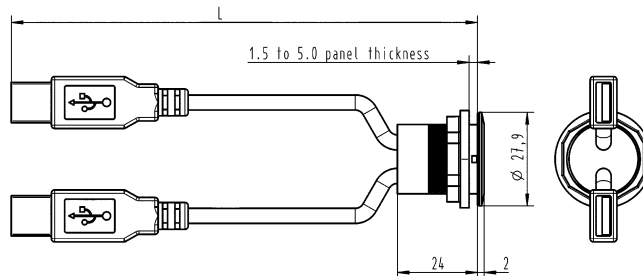

har-port USB 3.0 coupler

Type A jack –
Type A connector

Length:	Part number (silver)	Part number (black)
0.5 m	09 45 452 1930	09 45 452 1970
1.0 m	09 45 452 1931	09 45 452 1971
1.5 m	09 45 452 1932	09 45 452 1972
2.0 m	09 45 452 1933	09 45 452 1973
3.0 m	09 45 452 1934	09 45 452 1974

har-port USB 2.0 coupler

Type Mini-B jack –
Type A connector

Length:	Part number
0.5 m	09 45 452 1940

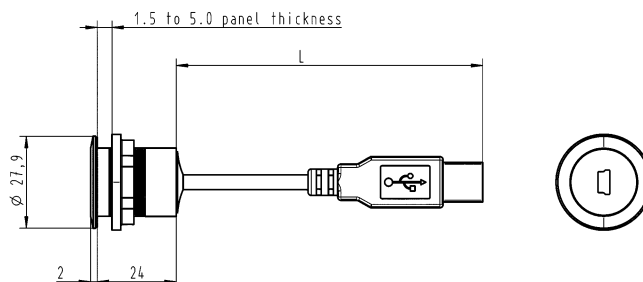

Connecting hardware

har-port RJ45 coupler

Identification	Part number silver	Drawing	Dimensions in mm
<p>har-port audio interface 3.5 mm</p> <p>stereo phone jack jack to connector</p> <p>Length: 1.0 m 2.0 m</p>	<p>09 45 452 1000 09 45 452 1001</p>		
<p>HDMI video interface</p>	<p>09 45 452 1010</p>		



har-port accessories

Advantages

- Compact and well-shaped service interface in a timeless attractive design
- Easy mounting
- Compact and robust design
- Practical accessories

Technical characteristics

Temperature range -25 °C ... +70 °C
 Housing material Polyamide

Identification	Part number	Drawing	Dimensions in mm
----------------	-------------	---------	------------------

Accessories

<i>har-port</i> protection cover IP65/IP67 black	09 45 502 0000		
<i>har-port</i> sealing cover IP40	09 45 502 0001		
<i>har-port</i> label holder	09 45 502 0002	 har-port label holder 09 45 502 0002	
<i>har-port</i> label for label holder 09 45 502 0002	09 45 502 0003	 position for har-port label 09 45 502 0003	
<i>har-port</i> blind cover IP65/IP67	09 45 502 0004		
<i>har-port</i> protection cover IP65/IP67 transparent	09 45 502 0005		
<i>har-port</i> protection cover IP65/IP67 metal	09 45 502 0006		



Directory Chapter 04

Page

General information

04.03

Han® F + B connector

04.04

The food industry relies on modern processing, portioning and packaging equipment. The controls (and therefore the associated Ethernet cable) hardly differ from those used in the machinery construction sector. However, all components that come into contact with food or are mounted at preparation sites are subject to special hygiene and cleaning regulations.

Thus, it is necessary to use compatible materials and also avoid any increased adhesion of dirt or bacteria.

HARTING uses only materials that comply with FDA 21 in our Han® F+B product series.

All facility and cabling components must also be rigorously and continuously cleaned. This results in additional, tougher demands on the cabling components compared to general industry requirements.

These include a higher degree of IPx protection and higher temperature requirements – so that long-term exposure to high-pressure steam cleaners causes

no malfunction or damage. Therefore, HARTING products in the Han® F+B series are designed with IP69K protection for a wide temperature range.

The Han® F+B series follows the “Easy to Clean” design in accordance with ISO 14 159 and DIN EN 1672-2. It is also certified according to the Ecolab Directive.

Currently, the Han® F+B portfolio for Ethernet cabling includes:

- RJ45 connectors for Fast Ethernet in Category 5
- RJ45 connectors for Gigabit Ethernet in Category 6A
- Matching protective housings with Han® 3 A design (according to IEC 61 076-3-106, variant 5)
- Connector housings based on M25 with the corresponding cable glands
- Accessories

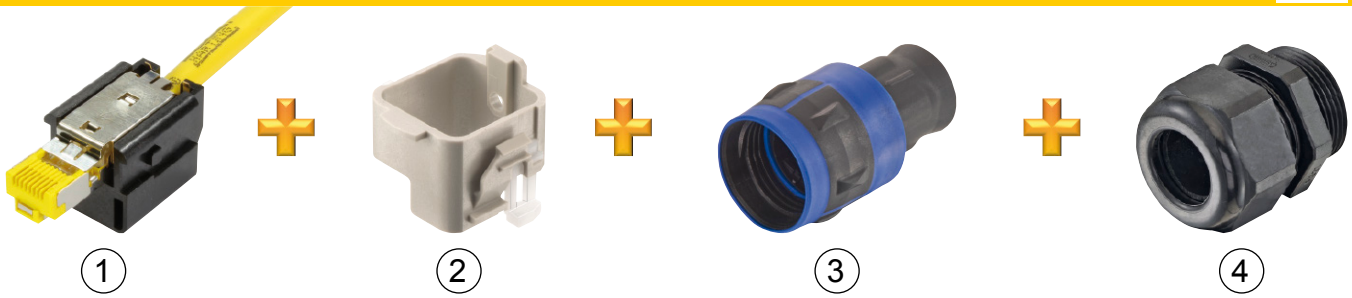

Han® F+B Ethernet connector for food industry

Features

- Connector type RJ45
- Category 5 / 6 / 6A
- Number of contacts 4 or 8

Application

- Machines for food industry
- Bottling plants
- Packaging machines
- Application areas
 - Interface inside the splash zone
 - Connections with chemical resistance and high cleaning cycles

Benefits

- Degree of protection IP69K
- Resistant against cold and heat
- Certified acc. to Ecolab
- „Easy to Clean” design acc. to ISO 14 159 and DIN EN 1672-2
- Materials acc. to FDA 21

Benefits

Strain relief

A suitable strain relief is required to enable the F+B connector to resist the stress caused e.g. by the daily cleaning of the machinery.

DIN VDE 0100-520: 2013-6 defines the stress relief for a connector depending on the outer diameter of the cable.

Technical characteristics

Connector type	RJ45 acc. to IEC 61076-3-106 variant 5
Number of contacts	4
Transmission performance	Category 5 / Class D up to 100 MHz acc. to ISO/IEC 11 801, EN 50 173-1
Transmission rate	10/100 Mbit/s
Number of contacts	8
Transmission performance	Category 6A / Class E _A up to 500 MHz acc. to ISO/IEC 11 801, EN 50 173-1
Transmission rate	10/100 Mbit/s and 1/10 Gbit/s
Shielding	fully shielded, 360° shielding contact
Housing	
Housing material	PP
Sealing material outside	EPDM/TPE
Limiting temperature	-40 °C ... +125 °C
Degree of protection acc. to DIN EN 60529 if mated	IP67 / IP69K
Housing locking	Screw locking
Materials and resistances	
Housing materials with FDA 21 approval	
Ecolab® tested	P3-topax 52 P3-topax 19 P3-topax 66 P3-topax 99 P3-topax 56 P3-topax 200
Acigel, Supergel, Tego 2000	



Han® F+B Ethernet connector for food industry

Identification	Part number	Drawing	Dimensions in mm
Han® 3 A RJ45 connector inserts ① Cat. 5, 4 poles, 10/100 Mbit/s IDC for AWG 24-22 solid and stranded Cat. 5, 4 poles, 10/100 Mbit/s IDC for AWG 26-24 solid and stranded Cat. 6, 8 poles, 10/100 Mbit/s and 1/10 Gbit/s IDC for AWG 27-22 solid and stranded Cat. 6 _A , 8 poles, 10/100 Mbit/s and 1/10 Gbit/s piercing termination for AWG 28-26 stranded Cat. 6 _A , 8 poles, 10/100 Mbit/s and 1/10 Gbit/s preLink® IDC for AWG 23/22 or AWG 27/26 depending on the separately orderable preLink® terminal module (20 82 000 0001/20 82 000 0003)	09 45 100 1100 09 45 100 1110 09 45 100 1560 09 45 100 1520 20 82 002 0001		
Han® F+B adapter for Han® 3 A inserts ②	09 15 503 9911		
Han® F+B connector housing M25 ③	19 15 503 1402		
Han® F+B cable glands M25 cable glands plastic ④ Sealing range 5 – 8 mm	19 15 503 5290		
Accessories Protection cap for Han® F+B connector housing	09 15 503 5411		

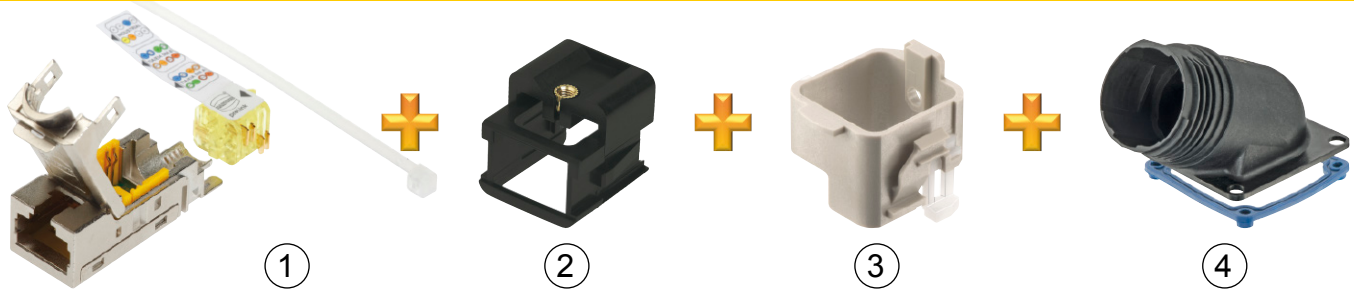

Han® F+B Ethernet panel feed-throughs for food industry

Identification	Part number	Drawing	Dimensions in mm
Han® 3 A RJ45 female inserts ① Cat. 5, 4 poles, 10/100 Mbit/s IDC for AWG 24-22 solid and stranded Cat. 6A, 8 poles, 10/100 Mbit/s and 1/10 Gbit/s IDC for AWG 28-24 solid and stranded Cat. 6A, 8 poles, 10/100 Mbit/s and 1/10 Gbit/s IDC for AWG 24-22 solid and stranded Cat. 6A, 8 poles, 10/100 Mbit/s and 1/10 Gbit/s preLink® IDC für AWG 23/22 solid and stranded Cat. 6A, 8 poles, 10/100 Mbit/s and 1/10 Gbit/s preLink® IDC für AWG 27/26 solid and stranded Cat. 6A, 8 poles, 10/100 Mbit/s and 1/10 Gbit/s preLink® IDC for AWG 23/22 or AWG 27/26 depending on the separately orderable preLink® terminal module (20 82 000 0001/20 82 000 0003) Cat. 6, 8 poles, 10/100 Mbit/s and 1/10 Gbit/s RJ45 system cable jack on connector 0.15 m ... 10.00 m Cat. 6, 8 poles, 10/100 Mbit/s and 1/10 Gbit/s RJ45 coupler with Han® 3 A adapter	09 45 545 1120 09 45 545 1561 09 45 545 1562 20 82 001 0001 20 82 001 0002 20 82 000 0002 09 45 545 1500 ... 09 45 545 1518 09 45 200 1560		

Connectors for food and beverage

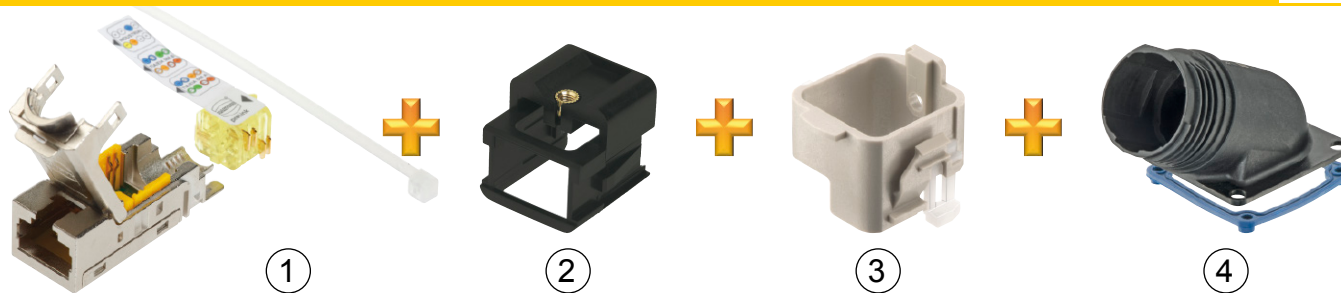

Han® F+B Ethernet panel feed-throughs for food industry

Identification	Part number	Drawing	Dimensions in mm
Han® 3 A adapter for HIFF inserts ②	09 45 515 0024		
Han® F+B adapter for Han® 3 A inserts ③	09 15 503 9911		
Han® F+B Housing bulkhead mounting ④ Straight type Angled type Housing cable-to-cable	09 15 503 0301 09 15 503 0901 09 15 503 1701		
Accessories Protection cap for Han® F+B Housing bulkhead mounting	09 15 503 5401		

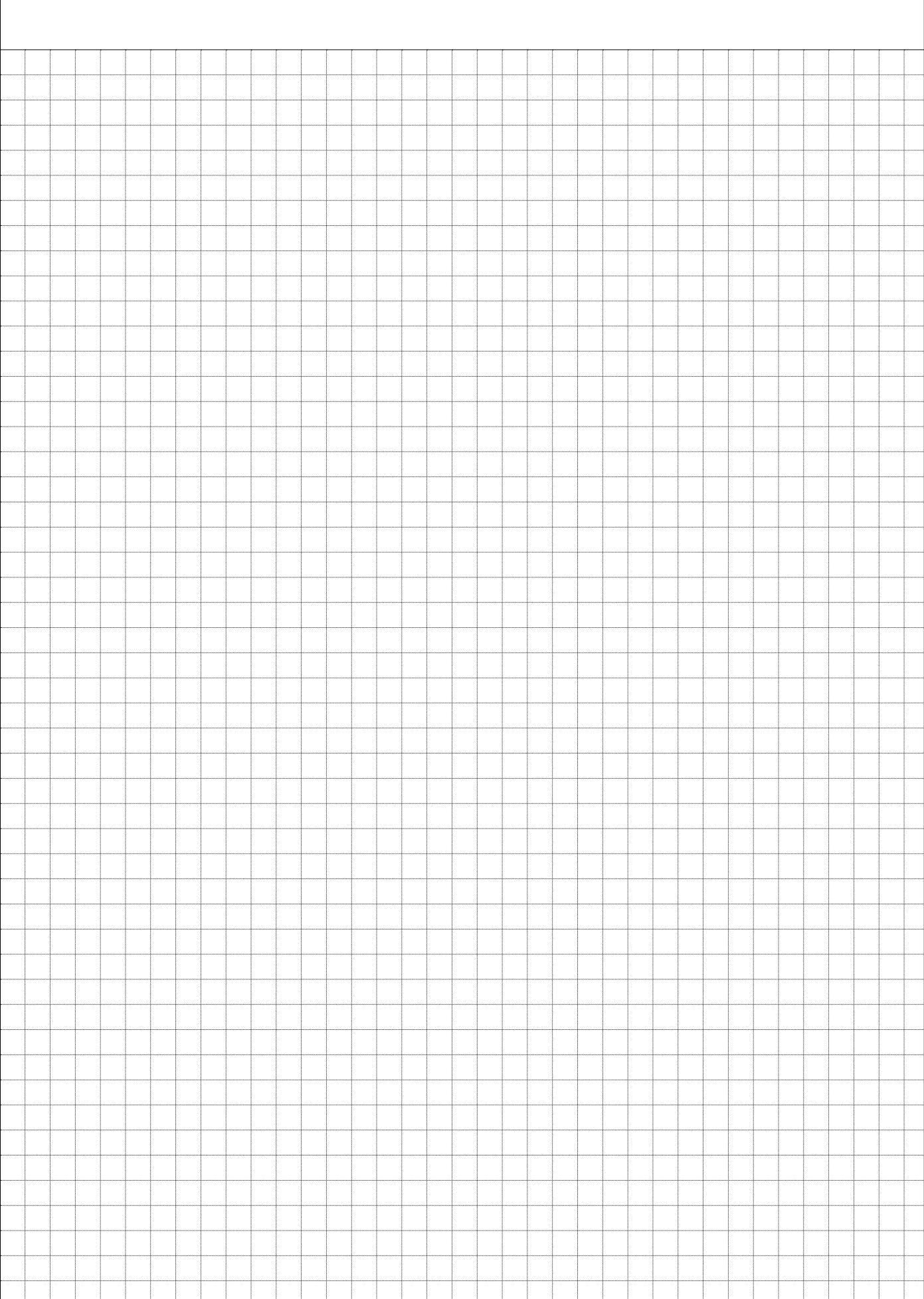

Directory Chapter 05

Page

General information	05.03
HARTING RJ Industrial® system cable, 4-wire	05.04
HARTING M12 system cable, 4-wire	05.06
Ha-VIS EtherRail® stranded railway cords, 4-wire	05.11
M12 connector, 4 poles	05.12
HARTING RJ45 connector set	05.14
Ha-VIS EtherRail® ultra flexible railway cords	05.15
M12 connectors, Slim Design	05.16
Han-Quintax® module	05.18
Han® MegaBit module	05.20
Ha-VIS EtherRail® stranded railway cords, 8-wire	05.23
M12 connector, 8 poles	05.24
HARTING RJ Industrial® system cable, 4-wire	05.25
HARTING M12 system cable, 8-wire	05.26
Han-Quintax® High Density module	05.30
Han® GigaBit module	05.32
Ha-VIS MVB data bus cable	05.34
Ha-VIS WTB data bus cable	05.36
D-Sub InduCom	05.40



A large grid of small squares, typical of graph paper, occupying most of the page.

Manufacturers and suppliers of railway vehicles as well as railway operators have relied on HARTING products for many years. This has resulted in very productive cooperation on several levels. The extremely robust and durable Han® connectors are now practically the standard used for almost all locomotives, railcars and long-haul and regional trains worldwide.

HARTING's range of solutions and products for these applications is very broad. This cabling catalogue, therefore, presents only the specific data networking components for Ethernet, WTB and MVB cabling (MVB = Multifunction Vehicle Bus, WTB = Wire Train Bus; both bus systems are still widely in use but are increasingly being replaced by Ethernet).

Specifically, these are:

- HARTING EtherRAIL® data cables (Category 5) for Fast Ethernet (100 Mbit/s), for installations in and on trains
- M12 D-coded connectors (IP65 / IP67) and RJ45 (IP20)
- HARTING EtherRAIL® data cables (Category 5) for Fast Ethernet (100 Mbit/s), for installations between railcars (very flexible)
- HARTING connectivity: Han Quintax® and Han® MegaBit modules specifically for railcar couplings
- HARTING EtherRAIL® data cables (Category 7) for Gigabit Ethernet and 10 GB, for installations in, on and between railcars
- har-speed M12 X-coded connectors (IP65 / IP67) for Gigabit Ethernet and 10 GB, installed in and on the train

- HARTING connectivity: Han Quintax® High Density and Han® GigaBit modules specifically for railcar couplings
- HARTING MVB and WTB bus cable
- HARTING D-Sub InduCom connection technology

All of these HARTING products are designed, manufactured and certified in accordance with the specific requirements of the railway sector.

These requirements are:

- Extremely high demands for vibration resistance (contact reliability, plug-in security, etc.)
- Above-average service life (e.g. 30 years or longer)
- High transmission reliability for all operating modes of the train (shielding, EMC safety)
- Extremely high temperature range (e.g. from -40 °C to +90 °C)
- Demanding safety requirements in case of fire (extensive fire tests in compliance with international, European, national and even company-specific regulations)

There are very few pre-assembled system cables listed in this catalogue. This is because the requirements mentioned above and the associated product tests lead to specific requirements for length, labelling and packaging that rule out standard products.

HARTING HCS (<http://www.harting-customised-solutions.com/en/home/>) provides customised solutions in the railway sector.



HARTING RJ Industrial®
system cable, overmoulded, 4-wire, straight

Features

- Connector types RJ45
- Category Cat. 5
- Number of wires 4
- Wiring 1:1
- Sheath material Elastomer, electron beam cross-linked

Application

- For harsh industrial environments
- For installation in railway applications

Benefits

- Robust design
- Fire protection acc. to EN 45545-1, -2 and -5

Technical characteristics

- Connector types 1 x resp. 2 x HARTING RJ Industrial® RJ45, overmoulded
- Railway cords type 4 x AWG 22/7, stranded
- Sheath material Elastomer, electron beam cross-linked
- Wiring 4 pole, 1:1
- Transmission performance Class D up to 100 MHz acc. to ISO/IEC 11801, EN 50173-1
- Transmission rate 10/100 Mbit/s
- Shielding Fully shielded, 360° shielding contact
- Operating temperature range -40 °C ... +70 °C
- Colour Black



HARTING RJ Industrial®
system cable, overmoulded, 4-wire, straight

Identification	Part number	Drawing	Dimensions in mm
----------------	-------------	---------	------------------

HARTING RJ Industrial®
system cable, 4-wire
one side assembled

Length	Part number
0.5 m	09 45 771 0211
1.0 m	09 45 771 0212
2.0 m	09 45 771 0214
3.0 m	09 45 771 0215
5.0 m	09 45 771 0216
10.0 m	09 45 771 0217

Black

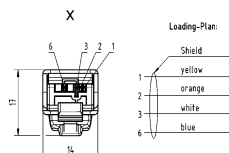
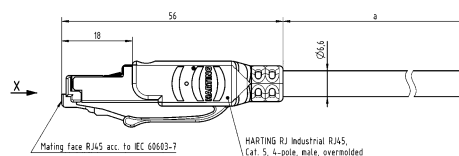

both sides assembled

Length	Part number
0.5 m	09 45 771 1212
1.0 m	09 45 771 1213
2.0 m	09 45 771 1219
3.0 m	09 45 771 1215
5.0 m	09 45 771 1216
10.0 m	09 45 771 1223

Black

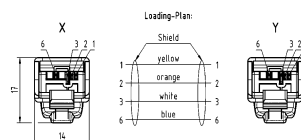
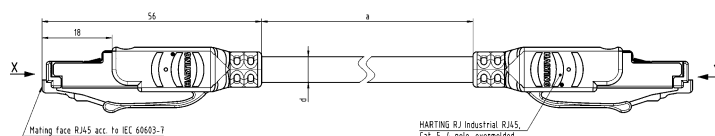



HARTING M12 system cable, 4-wire, straight resp. angled

Features

- Connector types M12 D-coding, connector straight resp. angled
- Category Cat. 5
- Number of wires 4
- Wiring 1:1
- Sheath material Elastomer, electron beam cross-linked

Application

- For harsh industrial environments
- For installation in railway applications

Benefits

- Robust design
- Protection degree IP65/IP67
- Fire protection acc. to EN 45545-1, -2 and -5

Technical characteristics

- Connector types HARTING M12 D-coding, overmoulded
- Railway cords type 4 x AWG 22/7, stranded
- Sheath material Elastomer, electron beam cross-linked
- Wiring 4 pole, 1:1
- Transmission performance Class D up to 100 MHz acc. to ISO/IEC 11801, EN 50173-1
- Transmission rate 10/100 Mbit/s
- Shielding Fully shielded, 360° shielding contact
- Operating temperature range fix operation -40 °C ... +85 °C
- Colour Black or blue



HARTING M12 system cable, 4-wire, straight resp. angled

Identification	Part number	Drawing	Dimensions in mm
----------------	-------------	---------	------------------

HARTING
M12 system cable,
4-wire, straight
one side assembled

Length	Part number
0.5 m	09 48 220 0011 005
1.0 m	09 48 220 0011 010
2.0 m	09 48 220 0011 020
2.5 m	09 48 220 0011 025
5.0 m	09 48 220 0011 050
7.5 m	09 48 220 0011 075
10.0 m	09 48 220 0011 100
15.0 m	09 48 220 0011 150
20.0 m	09 48 220 0011 200

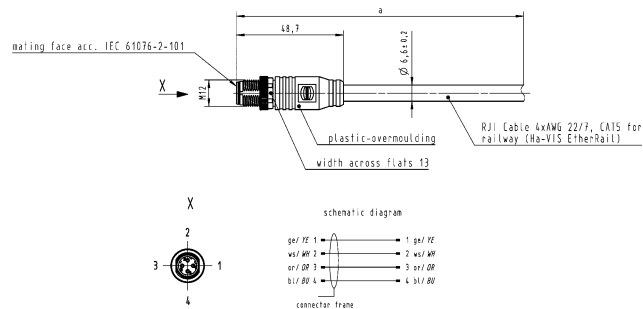

Length	Part number
0.5 m	21 33 390 0413 005
1.0 m	21 33 390 0413 010
2.0 m	21 33 390 0413 020
2.5 m	21 33 390 0413 025
5.0 m	21 33 390 0413 050
7.5 m	21 33 390 0413 075
10.0 m	21 33 390 0413 100
15.0 m	21 33 390 0413 150
20.0 m	21 33 390 0413 200

both sides assembled

Length	Part number
0.5 m	09 48 222 2011 005
1.0 m	09 48 222 2011 010
2.0 m	09 48 222 2011 020
2.5 m	09 48 222 2011 025
5.0 m	09 48 222 2011 050
7.5 m	09 48 222 2011 075
10.0 m	09 48 222 2011 100
15.0 m	09 48 222 2011 150
20.0 m	09 48 222 2011 200

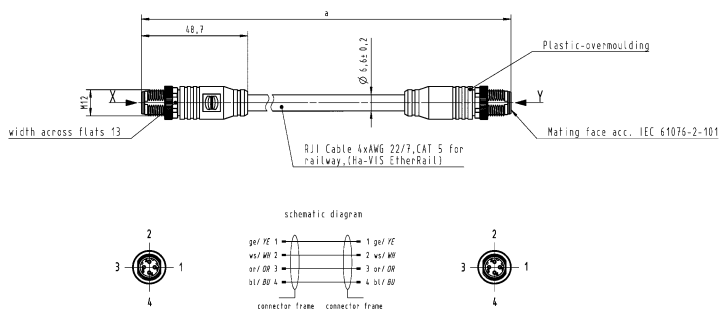



HARTING M12 system cable, 4-wire, straight resp. angled

Identification		Part number	Drawing	Dimensions in mm
HARTING M12 system cable, 4-wire, angled one side assembled		Black		Dimensions in mm
Length	0.5 m	09 48 800 0011 005		
	1.0 m	09 48 800 0011 010		
	2.0 m	09 48 800 0011 020		
	2.5 m	09 48 800 0011 025		
	5.0 m	09 48 800 0011 050		
	7.5 m	09 48 800 0011 075		
	10.0 m	09 48 800 0011 100		
	15.0 m	09 48 800 0011 150		
	20.0 m	09 48 800 0011 200		
both sides assembled		Black		
Length	0.5 m	09 48 808 0011 005		
	1.0 m	09 48 808 0011 010		
	2.0 m	09 48 808 0011 020		
	2.5 m	09 48 808 0011 025		
	5.0 m	09 48 808 0011 050		
	7.5 m	09 48 808 0011 075		
	10.0 m	09 48 808 0011 100		
	15.0 m	09 48 808 0011 150		
	20.0 m	09 48 808 0011 200		

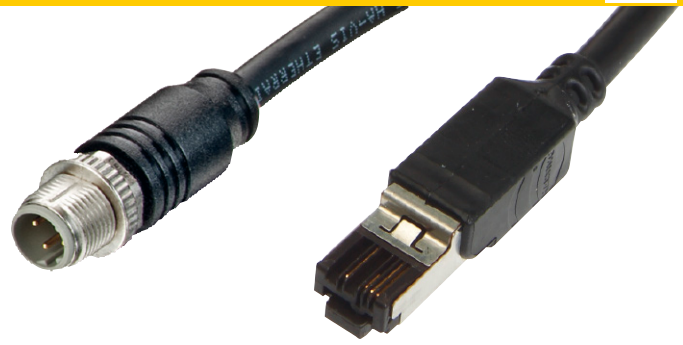

HARTING M12/RJ45 system cable, 4-wire, straight

Identification	Part number	Drawing	Dimensions in mm
<p>HARTING M12/RJ45 system cable, 4-wire</p> <p>both sides assembled</p>	<p>Black</p>	<p>The drawing shows a side view of the cable with dimensions: 18 mm for the M12 connector length, 56 mm for the cable length, 49 mm for the RJ45 connector length, and 16 mm for the RJ45 connector width. It also shows a top view of the RJ45 connector with pin numbers 1-4 and wire colors: yellow (1), orange (2), white (3), and blue (4). The drawing includes labels for the mating faces and the cable type: 'Mating face RJ45 acc. to IEC 61076-2-101', 'HARTING RJ Industrial RJ45, Cat. 5, 4-pole, overmolded, Protection level: IP20', and 'M12 D-Loaded straight overmolded male, Protection level: IP67'.</p>	<p>Length 1.0 m 09 48 022 2011 010</p> <p>1.5 m 09 48 022 2011 015</p> <p>2.0 m 09 48 022 2011 020</p> <p>3.0 m 09 48 022 2011 030</p> <p>5.0 m 09 48 022 2011 050</p> <p>7.5 m 09 48 022 2011 075</p> <p>10.0 m 09 48 022 2011 100</p> <p>15.0 m 09 48 022 2011 150</p> <p>20.0 m 09 48 022 2011 200</p>



HARTING M12
system cable, 4-wire, straight, PushPull Press & Go

Features

- Connector types M12 D-coding PushPull
- Category Cat. 5
- Number of wires 4
- Wiring 1:1
- Sheath material Elastomer, electron beam cross-linked

Application

- For harsh industrial environments
- For installation in railway applications

Benefits

- Robust design
- Protection degree IP65/IP67
- Fire protection acc. to EN 45545-1, -2 and -5
- M12 PushPull for a fast and vibration-free connection

Technical characteristics

- Connector types HARTING M12 D-coding PushPull
- Railway cords type 4 x AWG 22/7, stranded
- Sheath material Elastomer, electron beam cross-linked
- Wiring 4 pole, 1:1
- Transmission performance Class D up to 100 MHz acc. to ISO/IEC 11801, EN 50173-1
- Transmission rate 10/100 Mbit/s
- Shielding Fully shielded, 360° shielding contact
- Operating temperature range fix operation -40 °C ... +85 °C
- Colour Black

Identification	Part number	Drawing	Dimensions in mm
----------------	-------------	---------	------------------

HARTING
M12 system cable, 4-wire
both sides assembled

Black

Length	Part number
1.0 m	21 33 232 3401 010
1.5 m	21 33 232 3401 015
2.0 m	21 33 232 3401 020
3.0 m	21 33 232 3401 030
5.0 m	21 33 232 3401 050
10.0 m	21 33 232 3401 100

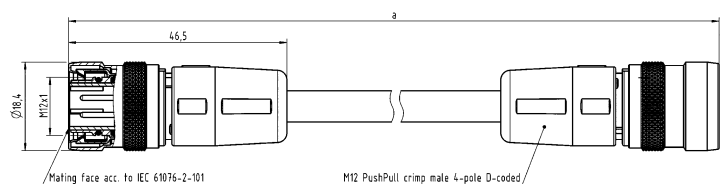

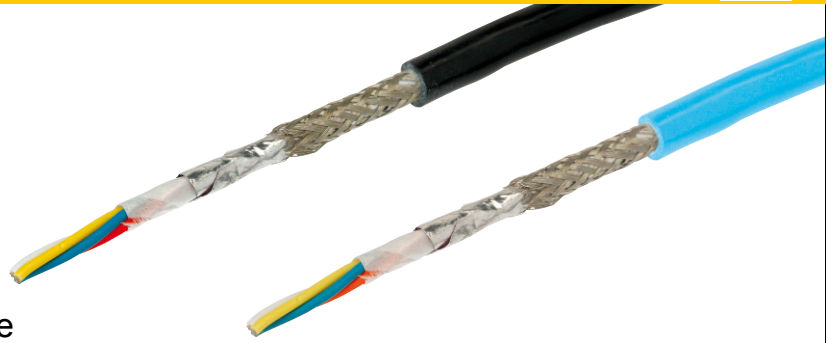

Ha-VIS EtherRail® stranded railway cords, Cat. 5e, 4-wire

Features

- Sheath material: Elastomer, electron beam cross-linked
- Category: 5
- Number of wires: 4
- Wire design: AWG 22/7
- Wire diameter: (6.6 ± 0.2) mm

Application

- For installation within and outside rail vehicles

Benefits

- Robust design
- Fire protection acc. to EN 45545-1, -2 and -5
- Flame-retardant and heat resistant acc. to DIN 5510 (1-4) and EN 50264-1
- UV protected
- RoHS compliant
- Halogen free
- Small Ø permits RJ45 assembly

Technical characteristics

- Cable structure: Star quad, double shielding
- Core structure: 4 x AWG 22/7, tinned copper wire, stranded
- Wire insulation: PE-Foam Skin, Ø 1.5 mm
- Sheath material: Elastomer, electron beam cross-linked
- Cable sheath diameter: 6.6 ± 0.2 mm
- Transmission performance: Category 5e, Class D up to 100 MHz acc. to ISO/IEC 11801, EN 50173-1
- Transmission rate: 10/100 Mbit/s
- Shielding: Shielding foil and shielding braid
- Operating temperature range:
 - fix operation: -40 °C ... +85 °C
 - flexible operation: -25 °C ... +70 °C
- Standard lengths: 100 m / 500 m / 1000 m
- Colour: Black or blue

Identification	Part number Elastomer		Drawing	Dimensions in mm
	Black	Blue		
Ha-VIS EtherRail® stranded railway cords, Cat. 5e 4-wire				
10 m ring	09 45 600 0168	09 45 600 1400		
50 m ring	09 45 600 0178	09 45 600 1410		
100 m ring	09 45 600 0108	09 45 600 1420		
500 m drum	09 45 600 0118	09 45 600 1430		
1000 m drum	09 45 600 0128	09 45 600 1440		



Mating face

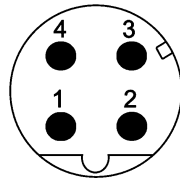

D-coding
Mating face
acc. to IEC 61076-2-101



Identification	Part number	Drawing	Dimensions in mm
----------------	-------------	---------	------------------

M12 Crimp Slim design, shielded



Male
4 poles, D-coding
Railway cords: 5.7 - 8.8 mm
outer diameter

21 03 881 1405*

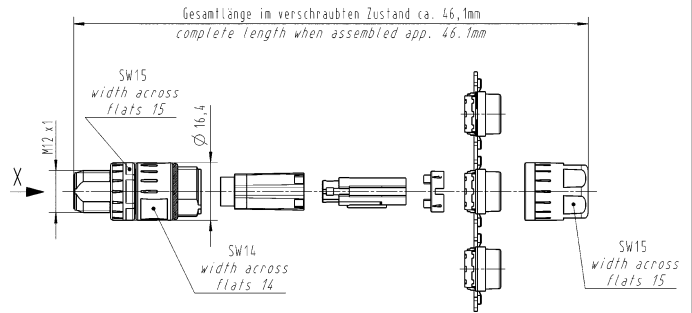

M12 Crimp, shielded



Male
4 poles, D-coding
angled

21 03 882 3405*

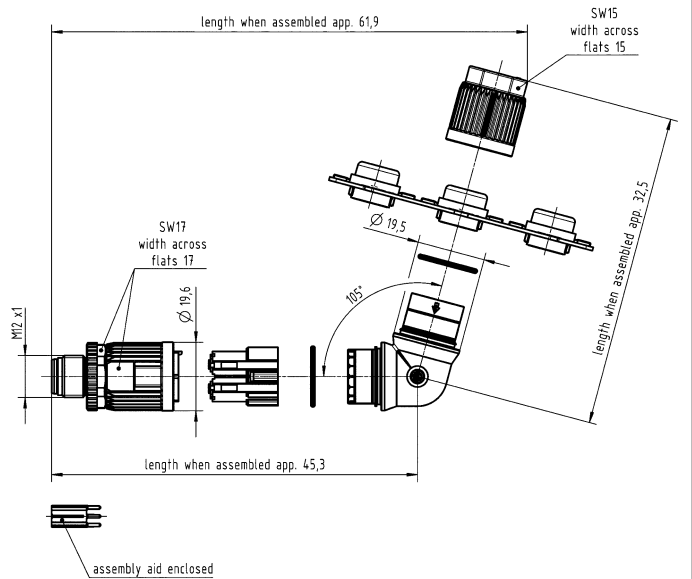



Mating face

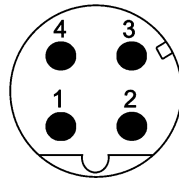

D-coding
Mating face
acc. to IEC 61076-2-101



Applications / Advantages

- M12 PushPull for a fast and vibration-free connection
- Simple assembly without tools
- You can hear it click into place
- Suitable for signal and data transmission

Identification	Part number	Drawing	Dimensions in mm
----------------	-------------	---------	------------------

M12 PushPull Slim design



Male
straight version
4 poles, D-coding, IP54
Cable diameter: 5.7 - 8.8 mm

21 03 881 1430

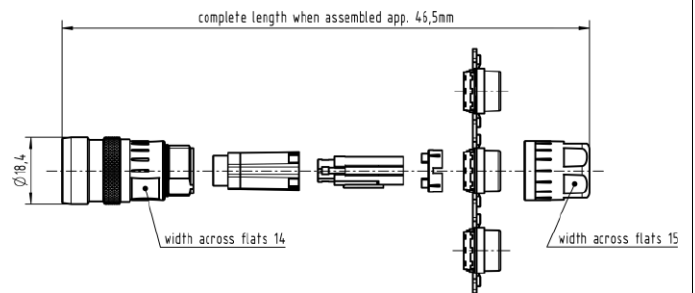

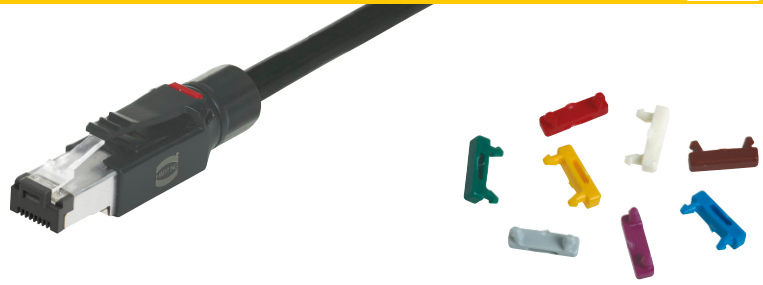

HARTING RJ Industrial® EtherRail® RJ45 connector set, 4 poles

Advantages

- RJ45 Ethernet-Data connector suitable for industry
- Field-assembly with *HARAX*® quick termination in IDC technology
- Compact design
- Ergonomically unlocking clip
- Less weight assures shock- and vibration resisting connection
- Category of transmission Cat. 5e
- Suitable for solid and stranded wires
- Suitable for PoE (IEEE 802.3af) and PoE+ (IEEE 802.3at)
- Optimized version for Ha-VIS EtherRail® Ethernet cable, Shielded Star Quad Cable, AWG 22/19 ultra-flexible, acc. Cat. 5e cabling standard (ISO/IEC 11801), part numbers 09 45 600 0188, 09 45 600 0138, 09 45 600 0148 and 09 45 600 0158

Technical characteristics

Connector type	RJ45 connector acc. to IEC 60603-7
Number of contacts	4
Transmission category	Category 5e, Class D
Transmission performance	Category 5e, Class D up to 100 MHz acc. to ISO/IEC 11801, EN 50173-1
Transmission rate	10/100 Mbit/s
Shielding	fully shielded, 360° shielding contact
Mounting	Field-assembly
Cable termination	with IDC-contacts, without tools
Connectable railway cords	
- Conductor cross section	AWG 27 ... AWG 22 (solid/stranded)
- Conductor diameter	max. 2 mm (incl. insulation)
- Cable diameter	4.5 ... 9 mm
Mating cycles	min. 750
Degree of protection	IP20
Temperature range	-40 °C ... +70 °C
Housing material	Polyamide, UL 94-V0
Colour	black

Identification	Part No.	Drawing	Dimensions in mm
----------------	----------	---------	------------------

HARTING RJ Industrial® EtherRail® RJ45 connector set, 4 poles

straight version

09 45 151 1122

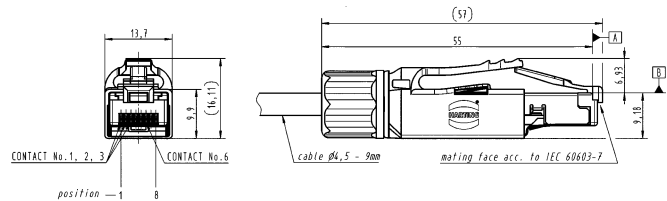

Identification	Colour	Part No.
----------------	--------	----------

Colour clips for colour coding the HARTING RJ Industrial® EtherRail® RJ45 connector

If required the colour clips can be equipped with an RFID-chip for automatic patch cable-ID recognition and storage.

White	09 45 850 0001
Grey	09 45 850 0002
Yellow	09 45 850 0003
Magenta	09 45 850 0005
Red	09 45 850 0007
Blue	09 45 850 0008
Green	09 45 850 0009
Brown	09 45 850 0010



Ha-VIS EtherRail® ultra flexible railway cords, Cat. 5e, 4-wire

Features

- Sheath material: Elastomer, electron beam cross-linked
- Category: 5
- Number of wires: 4
- Wire design: AWG 22/19
- Wire diameter: (7.4 ± 0.1) mm

Application

- For installation within and outside rail vehicles and especially between coaches

Benefits

- Robust design, especially suitable between coaches
- Fire protection acc. to EN 45545-1, -2 and -5
- Flame-retardant and heat resistant acc. to DIN 5510 (1-4) and EN 50264-1
- UV protected
- RoHS compliant
- Halogen free

Technical characteristics

- Cable structure: Star quad, double shielding
- Core structure: 4 x AWG 22/19, tinned copper wire, ultra flexible
- Wire insulation: PE, Ø 1.98 mm
- Sheath material: Elastomer, electron beam cross-linked
- Cable sheath diameter: 7.4 ± 1 mm
- Transmission performance: Category 5e, Class D up to 100 MHz acc. to ISO/IEC 11801, EN 50173-1
- Transmission rate: 10/100 Mbit/s
- Shielding: Shielding foil and shielding braid
- Operating temperature range: -40 °C ... +90 °C
- Standard lengths: 100 m/500 m/1000 m
- Colour: Black

Identification	Part number Elastomer	Drawing	Dimensions in mm
Ha-VIS EtherRail® ultra flexible railway cords, Cat. 5e 4-wire 10 m ring 50 m ring 100 m ring 500 m drum 1000 m drum	Black 09 45 600 0188 09 45 600 0189 09 45 600 0138 09 45 600 0148 09 45 600 0158		

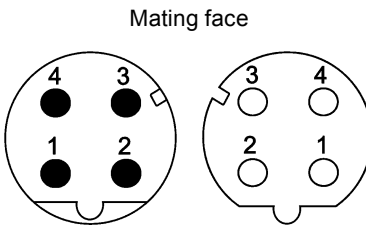

D-coding
Mating face
acc. to IEC 61076-2-101



Applications/Advantages

- M12 connector with the option to connect a plastic tube to protect the cable assembly in rough applications
- Robust design for IP65/IP67 environments
- A- and D-coding available with crimp termination
- 360° shielding

Identification	Part number	Drawing	Dimensions in mm
<p>M12 connector with PMA connection for PVC tube NW10</p> <p>Male 4 poles, D-coding</p>	21 03 882 1411		
<p>M12 connector with PMA connection for PVC tube NW10</p> <p>Female 4 poles, D-coding</p>	21 03 882 2411		

M12 connectors D-coding



Mating face

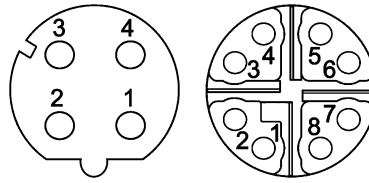

D-coding
Mating face
acc. to IEC 61076-2-101



Identification	Part number	Drawing	Dimensions in mm
----------------	-------------	---------	------------------

M12 PFT Slim Design



Female
4 poles, D-coding

21 03 881 2425

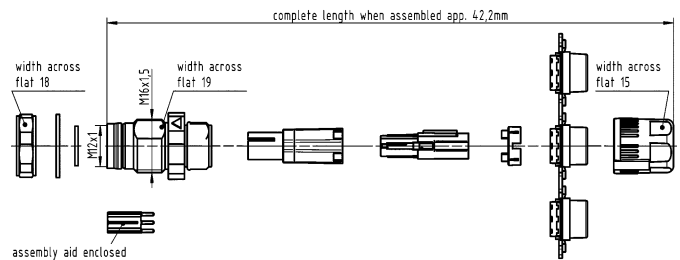

M12 PFT Slim Design



Female
8 poles, X-coding
0.08 - 0.25 mm²
AWG 28 - 23

21 03 881 2825

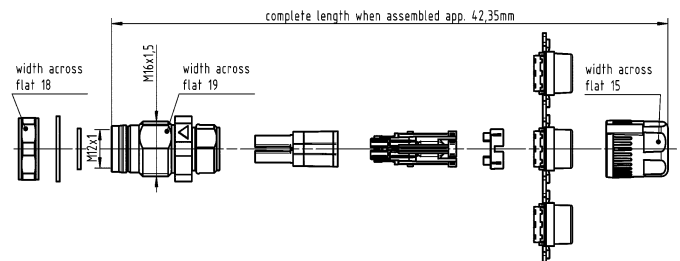

Features

- Shielding bus separate from housing potential
- Suitable for the transmission of sensitive signals (e.g. bus signals)
- The four pole Han® Quintax contact is suitable for Ethernet Cat. 5e and PROFIBUS when diagonally wiring of the data pairs

Specifications / Approvals

IEC 60664-1
IEC 61984



Technical characteristics

Contacts	2
Electrical data acc. to IEC 61984	10 A 50 V 0.8 kV 3
Rated current	10 A
Rated voltage	50 V
Rated impulse voltage	0.8 kV
Pollution degree	3
Insulation resistance	≥ 10 ¹⁰ Ohm
Limiting temperatures	-40 °C ... 85 °C
Flammability (insert) acc. to UL 94	V 0
Mating cycles	≥ 500
Material (insert)	polycarbonate, zinc alloy
Colour (insert)	RAL 7032 (light grey)
Material (contact)	copper alloy
Material (accessories)	metal

Details





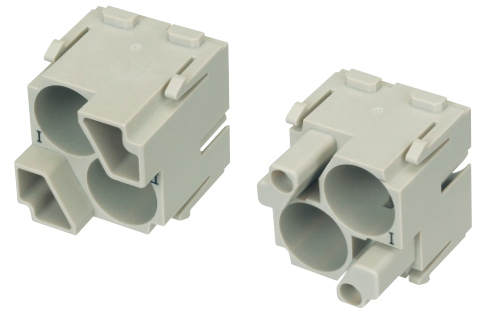

Remarks on the crimp technique

The wire gauges mentioned in the catalogue refer to geometric wire gauges of railway cords.

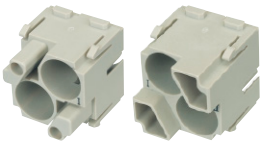
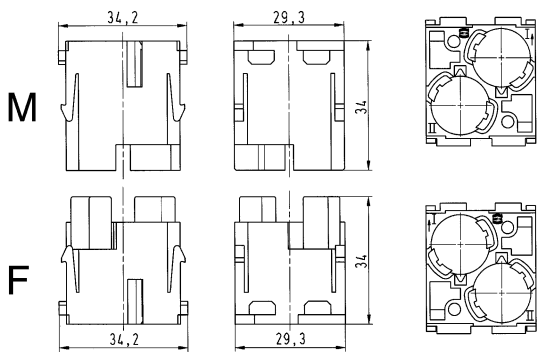
Number of contacts

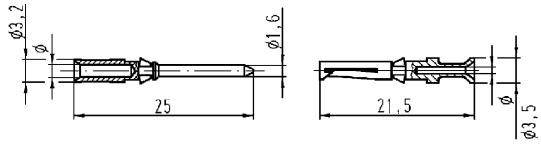
2

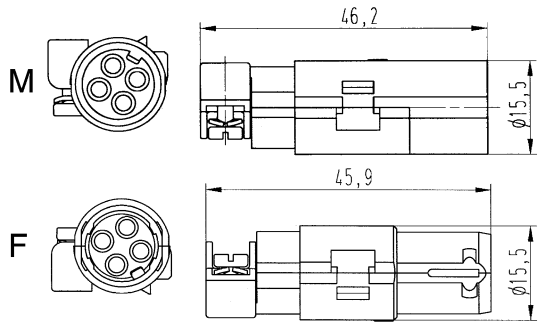

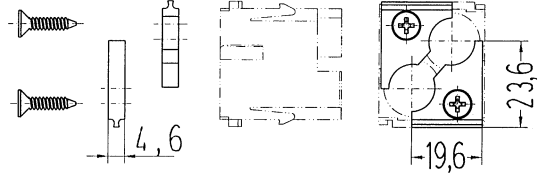
Identification	Wire gauge (mm ²)	Part number		Drawing	Dimensions in mm																					
		male	female																							
Han-Modular® Han-Quintax® module Crimp terminal 		09 14 002 3001	09 14 002 3101	 <p>M</p> <p>F</p> <p>Contact arrangement (view from termination side)</p>																						
Han D® Crimp contact, gold plated contacts, contact resistance ≤ 3 mOhm 	0.14-0.37 0.5 0.75 1 1.5 2.5	09 15 000 6124 09 15 000 6123 09 15 000 6125 09 15 000 6122 09 15 000 6121 09 15 000 6126	09 15 000 6224 09 15 000 6223 09 15 000 6225 09 15 000 6222 09 15 000 6221 09 15 000 6226	 <table border="1" data-bbox="957 1198 1500 1422"> <thead> <tr> <th>Wire gauge</th> <th>Ø</th> <th>Stripping length</th> </tr> </thead> <tbody> <tr> <td>0.14 - 0.37 mm² AWG 26-22</td> <td>0.9 mm</td> <td>8 mm</td> </tr> <tr> <td>0.5 mm² AWG 20</td> <td>1.1 mm</td> <td>8 mm</td> </tr> <tr> <td>0.75 mm² AWG 18</td> <td>1.3 mm</td> <td>8 mm</td> </tr> <tr> <td>1 mm² AWG 18</td> <td>1.45 mm</td> <td>8 mm</td> </tr> <tr> <td>1.5 mm² AWG 16</td> <td>1.75 mm</td> <td>8 mm</td> </tr> <tr> <td>2.5 mm² AWG 14</td> <td>2.25 mm</td> <td>6 mm</td> </tr> </tbody> </table>	Wire gauge	Ø	Stripping length	0.14 - 0.37 mm ² AWG 26-22	0.9 mm	8 mm	0.5 mm ² AWG 20	1.1 mm	8 mm	0.75 mm ² AWG 18	1.3 mm	8 mm	1 mm ² AWG 18	1.45 mm	8 mm	1.5 mm ² AWG 16	1.75 mm	8 mm	2.5 mm ² AWG 14	2.25 mm	6 mm	
Wire gauge	Ø	Stripping length																								
0.14 - 0.37 mm ² AWG 26-22	0.9 mm	8 mm																								
0.5 mm ² AWG 20	1.1 mm	8 mm																								
0.75 mm ² AWG 18	1.3 mm	8 mm																								
1 mm ² AWG 18	1.45 mm	8 mm																								
1.5 mm ² AWG 16	1.75 mm	8 mm																								
2.5 mm ² AWG 14	2.25 mm	6 mm																								
Han-Quintax® contact 4 + shielding, for Han D® crimp contacts  <p>Please order crimp contacts separately</p>		09 15 004 3013	09 15 004 3113	 <p>M</p> <p>F</p>																						
Han-Quintax® Adapter  <p>optional</p>		09 14 000 9915	09 14 000 9915																							

Features

- Shielding bus separate from housing potential
- Suitable for Fast Ethernet 100 Mbit/s (1 x 4) or Gigabit Ethernet 1000 Mbit/s (2 x 4) Cat. 5e. By the connection of two 4-wire EtherRail® railway cords (4 x AWG 22/19 resp. 4 x AWG 22/7) the transmission of Gigabit Ethernet is possible.
- Suitable for Han® B, Han® M, Han® EMC and Han® HPR hoods/housings, high construction

Specifications / Approvals

DIN EN 60664-1
DIN EN 61984



Technical characteristics

Contacts	2
Electrical data acc. to IEC 61984	10 A 50 V 0.8 kV 3
Rated current	10 A
Rated voltage	50 V
Rated impulse voltage	0.8 kV
Pollution degree	3
Insulation resistance	≥ 10 ¹⁰ Ohm
Limiting temperatures	-40 °C ... 125 °C -40 °C ... 85 °C
Flammability (insert) acc. to UL 94	V 0
Mating cycles	≥ 500
Material (insert)	polycarbonate
Colour (insert)	RAL 7032 (light grey)
Material (contact)	copper alloy
Material (shielding element)	zinc die-cast alloy
Material (outer conductor)	zinc alloy
Surface (outer conductor)	nickel plated contacts

Details

Remarks on the crimp technique

The wire gauges mentioned in the catalogue refer to geometric wire gauges of railway cords.

Number of contacts

2 x 4

50 V
10 A

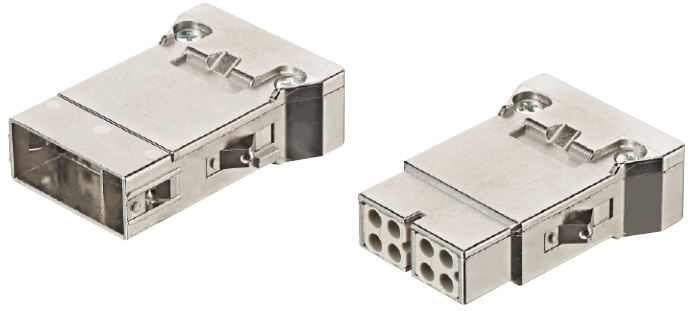

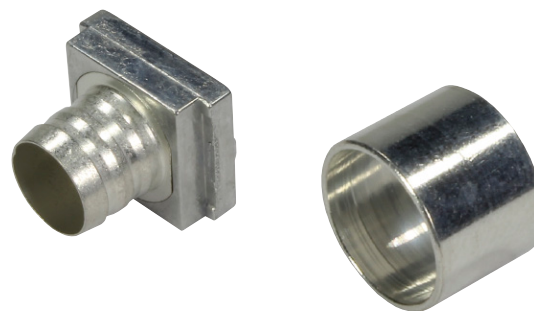

Identification	Wire gauge (mm ²)	Part number		Drawing	Dimensions in mm																												
		male	female																														
<p>Han-Modular®, Han® Megabit Insert</p> <p>Crimp terminal Please order crimp contacts separately Please order the adapter module separately</p>		09 14 008 3016	09 14 008 3116																														
<p>Han-Modular®, Han® Megabit Insert</p> <p>Crimp terminal, with additional shield connection to the hinged frame Please order crimp contacts separately Please order the adapter module separately</p>		09 14 008 3017	09 14 008 3117																														
<p>Han-Modular®, Adapter module</p>		09 14 001 3011	09 14 001 3111																														
<p>Han D®</p> <p>Crimp contact, gold plated contacts, contact resistance ≤ 3 mOhm</p>	0.14-0.37 0.5 0.75 1 1.5 2.5	09 15 000 6124 09 15 000 6123 09 15 000 6125 09 15 000 6122 09 15 000 6121 09 15 000 6126	09 15 000 6224 09 15 000 6223 09 15 000 6225 09 15 000 6222 09 15 000 6221 09 15 000 6226																														
				<table border="1"> <thead> <tr> <th colspan="2">Wire gauge</th> <th>Ø</th> <th>Stripping length</th> </tr> </thead> <tbody> <tr> <td>0.14 - 0.37 mm²</td> <td>AWG 26-22</td> <td>0.9 mm</td> <td>8 mm</td> </tr> <tr> <td>0.5 mm²</td> <td>AWG 20</td> <td>1.1 mm</td> <td>8 mm</td> </tr> <tr> <td>0.75 mm²</td> <td>AWG 18</td> <td>1.3 mm</td> <td>8 mm</td> </tr> <tr> <td>1 mm²</td> <td>AWG 18</td> <td>1.45 mm</td> <td>8 mm</td> </tr> <tr> <td>1.5 mm²</td> <td>AWG 16</td> <td>1.75 mm</td> <td>8 mm</td> </tr> <tr> <td>2.5 mm²</td> <td>AWG 14</td> <td>2.25 mm</td> <td>6 mm</td> </tr> </tbody> </table>	Wire gauge		Ø	Stripping length	0.14 - 0.37 mm ²	AWG 26-22	0.9 mm	8 mm	0.5 mm ²	AWG 20	1.1 mm	8 mm	0.75 mm ²	AWG 18	1.3 mm	8 mm	1 mm ²	AWG 18	1.45 mm	8 mm	1.5 mm ²	AWG 16	1.75 mm	8 mm	2.5 mm ²	AWG 14	2.25 mm	6 mm	
Wire gauge		Ø	Stripping length																														
0.14 - 0.37 mm ²	AWG 26-22	0.9 mm	8 mm																														
0.5 mm ²	AWG 20	1.1 mm	8 mm																														
0.75 mm ²	AWG 18	1.3 mm	8 mm																														
1 mm ²	AWG 18	1.45 mm	8 mm																														
1.5 mm ²	AWG 16	1.75 mm	8 mm																														
2.5 mm ²	AWG 14	2.25 mm	6 mm																														

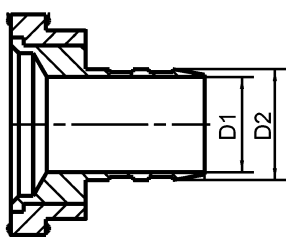

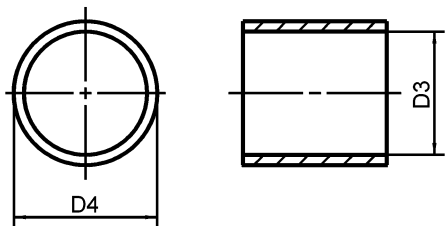
Identification	D1	D2	Part number	Drawing	Dimensions in mm
Crimp flange  HARTING offers to test and define the best crimp flange and ferrule combination for customer-specific railway cords.	3 mm	4 mm	61 03 000 0062		
	4 mm	5 mm	61 03 000 0064		
	5 mm	6 mm	61 03 000 0066		
	6 mm	7 mm	61 03 000 0067		
	7 mm	8 mm	61 03 000 0069		
	8 mm	9 mm	61 03 000 0071		
	9 mm	10 mm	61 03 000 0072		
	3.5 mm	4 mm	61 03 000 0063		
	4.5 mm	5.5 mm	61 03 000 0065		
	5.5 mm	6.5 mm	61 03 000 0166		
	6.5 mm	7.5 mm	61 03 000 0068		
	7.5 mm	8.5 mm	61 03 000 0070		
	18.5 mm	19.5 mm	61 03 000 0165		

Identification	D3	D4	Part number	Drawing	Dimensions in mm
Crimp ferrule  HARTING offers to test and define the best crimp flange and ferrule combination for customer-specific railway cords.	5 mm	6 mm	61 03 000 0045		
	6 mm	7 mm	61 03 000 0047		
	7 mm	8 mm	61 03 000 0049		
	8 mm	9 mm	61 03 000 0051		
	9 mm	10 mm	61 03 000 0053		
	10 mm	11 mm	61 03 000 0055		
	11 mm	12 mm	61 03 000 0057		
	12 mm	13 mm	61 03 000 0142		
	13 mm	14 mm	61 03 000 0127		
	5.5 mm	6.5 mm	61 03 000 0046		
	6.5 mm	7.5 mm	61 03 000 0048		
	7.5 mm	8.5 mm	61 03 000 0050		
	8.5 mm	9.5 mm	61 03 000 0052		
	9.5 mm	10.5 mm	61 03 000 0054		
	10.5 mm	11.5 mm	61 03 000 0056		
	11.5 mm	12.5 mm	61 03 000 0058		
	12.5 mm	13.5 mm	61 03 000 0059		

Cable clamp 5 ... 7 mm 	61 03 000 0141
Cable clamp 7 ... 10 mm 	61 03 000 0044
Cable clamp 10 ... 12 mm 	61 03 000 0143

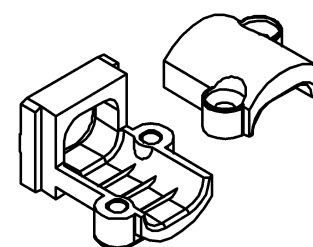

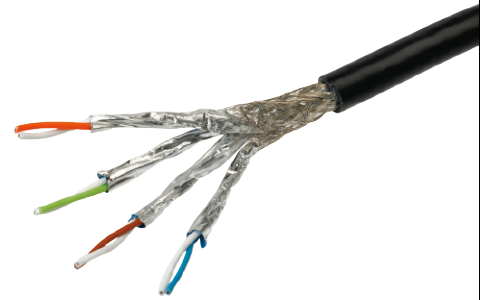

Ha-VIS EtherRail® stranded railway cords, Cat. 7, 8-wire

Features

- Sheath material Elastomer, electron beam cross-linked
- Category 7
- Number of wires 8
- Wire design AWG 24/7
- Wire diameter (8.1 ± 0.4) mm

Application

- For installation within and outside rail vehicles and buses

Benefits

- Transmission of Gigabit and 10 Gigabit Ethernet acc. IEEE 802.3 and multimedia services
- For installation within and outside rail vehicles and buses
- Fire protection acc. EN 45545-1, -2 and -5, flame retardant and heat resistant acc. DIN 5510 (1-4) and EN 50264-1
- UV resistant, RoHS conform, halogen free LSZH
- Designed to be compatible with products from HARTING like *har-speed* M12 Crimp, Han® GigaBit module and RJ45 10G.

Technical characteristics

- Cable structure 4 x 2, Twisted Pair, shielded, PIMF
- Core structure 4 x 2 x AWG 24/7, tinned copper wire
- Wire insulation PE, Ø 1.45 mm
- Sheath material Elastomer, electron beam, cross-linked
- Cable sheath diameter (8.8 ± 0.2) mm
- Transmission performance Category 7, Class D, E, E_A, F up to 600 MHz acc. to ISO/IEC 11801 and EN 50173-1
- Transmission rate 1/10 Gbit/s
- Shielding Paired shielded with additional cable shield
- Operating temperature range -40 °C ... +80 °C
- Colour Black

Identification

Ha-VIS EtherRail®
flexible data cable, PIMF
4x2xAWG 24/7, Cat. 7

- 10 m ring
- 50 m ring
- 100 m ring
- 500 m reel
- 1000 m reel

Part number

- 09 45 600 0694
- 09 45 600 0693
- 09 45 600 0692
- 09 45 600 0691
- 09 45 600 0690

Drawing

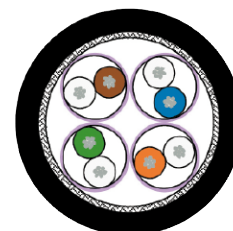

Dimensions in mm



Mating face

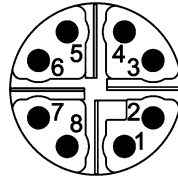

X-coding
Mating face
acc. to IEC 61076-2-109



Applications/Advantages

- High-Speed Ethernet applications for process automatization, e.g. camera system for process control in the production
- Maximum data rates through the configuration of the contacts in conformance with Ethernet technology. Transfer class E_A for 1 and 10 Gigabit
- Wire termination by using crimp contacts
- Perfect shielding through paired shielding of the contacts
- Overmoulded system cables in various lengths

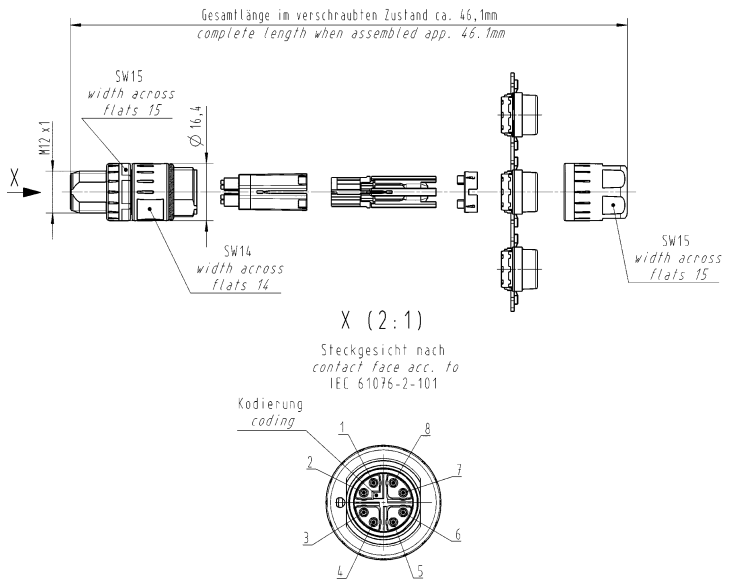
Identification	Part number	Drawing	Dimensions in mm
<p><i>har-speed M12 Slim design</i></p>  <p>Male straight version 8 poles, Cat. 6_A Cable diameter: 5.7 - 8.8 mm</p>	<p>21 03 881 1805</p>	 <p>Gesamtlänge im verschraubten Zustand ca. 46,1mm complete length when assembled app. 46.1mm</p> <p>SW15 width across flats 15</p> <p>SW14 width across flats 14</p> <p>SW15 width across flats 15</p> <p>X (2:1) Steckgesicht nach contact face acc. to IEC 61076-2-101</p> <p>Kodierung coding</p>	



HARTING RJ Industrial® 10G system cable, 8-wire, straight

Features

• Connector type	HARTING RJ Industrial® 10 G
• Category	6 _A
• Number of wires	8
• Wire design	AWG 24/7
• Wire diameter	(8.1 ± 0.4) mm
• Sheath material	Elastomer, electron beam cross-linked

Application

- For harsh industrial environments
- For installation in railway applications

Benefits

- Transmission of Gigabit and 10 Gigabit Ethernet acc. IEEE 802.3 and multimedia services
- Fire protection acc. EN 45545-1, -2 and -5, flame retardant and heat resistant acc. DIN 5510 (1-4) and EN 50264-1
- UV resistant, RoHS conform, halogen free LSZH

Technical characteristics

Connector types	HARTING RJ Industrial® 10 G
Cable structure	4 x 2, Twisted Pair, shielded, PIMF
Railway cords type	4 x 2 x AWG 24/7 Category 7, Class F up to 600 MHz acc. to ISO/IEC 11801 and EN 50173-1
Sheath material	Elastomer, electron beam, cross-linked
Cable sheath diameter	(8.1 ± 0.4) mm
Transmission performance	Category 6 _A , Class E _A up to 500 MHz acc. to ISO/IEC 11801 and EN 50173-1
Transmission rate	1/10 Gbit/s
Shielding	Paired shielded with additional cable shield
Operating temperature range	-40 °C ... +80 °C
Colour	Black

Identification

HARTING RJ Industrial® 10G system cable, 8-wire
both sides assembled

Part number

Black

Drawing

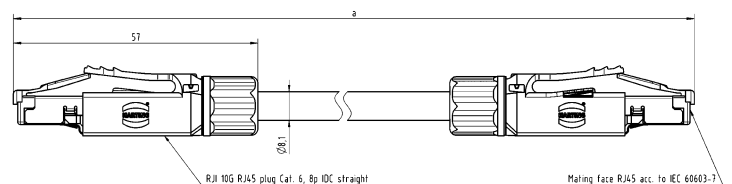

Dimensions in mm

Length	0.5 m	09 48 636 3751 005
	1.0 m	09 48 636 3751 010
	2.0 m	09 48 636 3751 020
	5.0 m	09 48 636 3751 050
	7.5 m	09 48 636 3751 075
	10.0 m	09 48 636 3751 100



HARTING M12
system cable, 8-wire, straight

Features

- Connector type M12 X-coding
- Category 6_A
- Number of wires 8
- Wire design AWG 24/7
- Wire diameter (8.1 ± 0.4) mm
- Sheath material Elastomer, electron beam cross-linked

Application

- For harsh industrial environments
- For installation in railway applications

Benefits

- Transmission of Gigabit and 10 Gigabit Ethernet acc. IEEE 802.3 and multimedia services
- Fire protection acc. EN 45545-1, -2 and -5, flame retardant and heat resistant acc. DIN 5510 (1-4) and EN 50 264-1
- UV resistant, RoHS conform, halogen free LSZH

Technical characteristics

- Connector types HARTING M12 X-coding
- Cable structure 4 x 2, Twisted Pair, shielded, PIMF
- Railway cords type 4 x 2 x AWG 24/7
Category 7, Class F
up to 600 MHz
acc. to ISO/IEC 11801
and EN 50 173-1
- Sheath material Elastomer, electron beam, cross-linked
- Cable sheath diameter (8.1 ± 0.4) mm
- Transmission performance Category 6_A, Class E_A
up to 500 MHz
acc. to ISO/IEC 11801
and EN 50 173-1
- Transmission rate 1/10 Gbit/s
- Shielding Paired shielded with additional cable shield
- Operating temperature range -40 °C ... +80 °C
- Colour Black



HARTING M12 system cable, 8-wire, straight

Identification

Part number

Drawing

Dimensions in mm

HARTING M12 system cable, 8-wire, Slim Design
both sides assembled

Length	Part number
0.5 m	21 33 010 1853 005
1.0 m	21 33 010 1853 010
2.0 m	21 33 010 1853 020
2.5 m	21 33 010 1853 025
5.0 m	21 33 010 1853 050
7.5 m	21 33 010 1853 075
10.0 m	21 33 010 1853 100
15.0 m	21 33 010 1853 150
20.0 m	21 33 010 1853 200

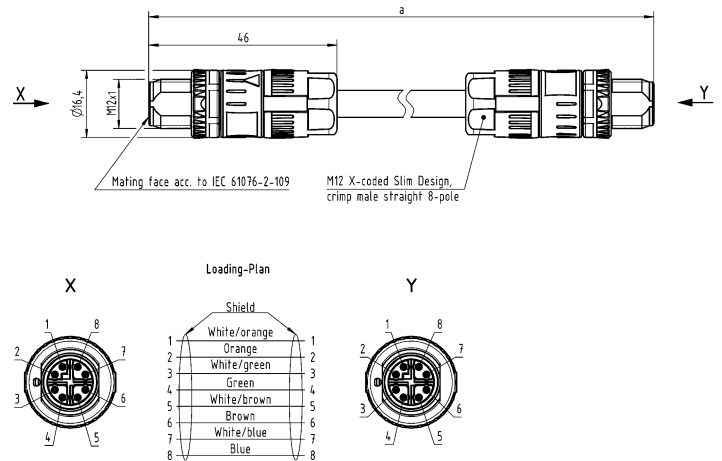

HARTING M12 system cable, 8-wire, Press & Go
one side assembled

Length	Part number
0.5 m	21 33 050 0853 005
1.0 m	21 33 050 0853 010
2.0 m	21 33 050 0853 020
2.5 m	21 33 050 0853 025
5.0 m	21 33 050 0853 050
7.5 m	21 33 050 0853 075
10.0 m	21 33 050 0853 100
15.0 m	21 33 050 0853 150
20.0 m	21 33 050 0853 200

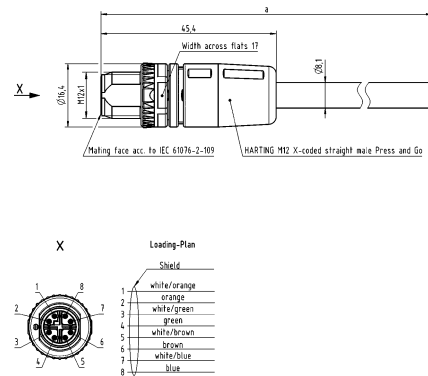

both sides assembled

Length	Part number
0.5 m	21 33 050 5853 005
1.0 m	21 33 050 5853 010
2.0 m	21 33 050 5853 020
2.5 m	21 33 050 5853 025
5.0 m	21 33 050 5853 050
7.5 m	21 33 050 5853 075
10.0 m	21 33 050 5853 100
15.0 m	21 33 050 5853 150
20.0 m	21 33 050 5853 200

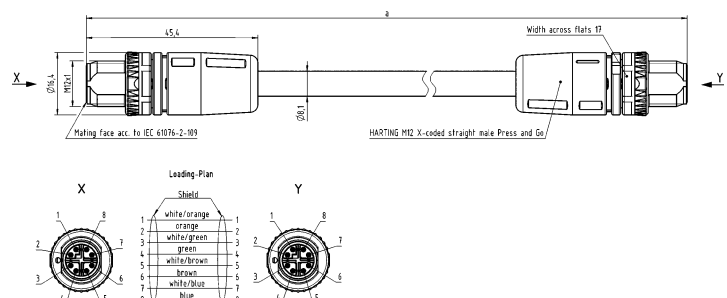



HARTING M12
system cable, 8-wire, straight, PushPull Press & Go

Features

- Connector type M12 X-coding PushPull
- Category 6_A
- Number of wires 8
- Wire design AWG 24/7
- Wire diameter (8.1 ± 0.4) mm
- Sheath material Elastomer, electron beam cross-linked

Application

- For harsh industrial environments
- For installation in railway applications

Benefits

- Transmission of Gigabit and 10 Gigabit Ethernet acc. IEEE 802.3 and multimedia services
- Fire protection acc. EN 45545-1, -2 and -5, flame retardant and heat resistant acc. DIN 5510 (1-4) and EN 50264-1
- UV resistant, RoHS conform, halogen free LSZH
- M12 PushPull for a fast and vibration-free connection

Technical characteristics

- Connector types HARTING M12 X-coding PushPull
- Cable structure 4 x 2, Twisted Pair, shielded, PIMF
- Railway cords type 4 x 2 x AWG 24/7
Category 7, Class F
up to 600 MHz
acc. to ISO/IEC 11801
and EN 50173-1
- Sheath material Elastomer, electron beam, cross-linked
- Cable sheath diameter (8.1 ± 0.4) mm
- Transmission performance Category 6_A, Class E_A
up to 500 MHz
acc. to ISO/IEC 11801
and EN 50173-1
- Transmission rate 1/10 Gbit/s
- Shielding Paired shielded with additional cable shield
- Operating temperature range -40 °C ... +80 °C
- Colour Black



HARTING M12 system cable, 8-wire, straight, PushPull Press & Go

Identification	Part number PVC	Drawing	Dimensions in mm
HARTING M12 system cable, 8-wire, PushPull Press & Go one side assembled	Black		
Length			
0.5 m	21 33 290 0853 005		
1.0 m	21 33 290 0853 010		
2.0 m	21 33 290 0853 020		
2.5 m	21 33 290 0853 025		
5.0 m	21 33 290 0853 050		
7.5 m	21 33 290 0853 075		
10.0 m	21 33 290 0853 100		
15.0 m	21 33 290 0853 150		
20.0 m	21 33 290 0853 200		
both sides assembled	Black		
Length			
0.5 m	21 33 292 9853 005		
1.0 m	21 33 292 9853 010		
2.0 m	21 33 292 9853 020		
2.5 m	21 33 292 9853 025		
5.0 m	21 33 292 9853 050		
7.5 m	21 33 292 9853 075		
10.0 m	21 33 292 9853 100		
15.0 m	21 33 292 9853 150		
20.0 m	21 33 292 9853 200		

Other cable lengths on request

Technical characteristics

Specifications / Approvals

Contacts	2
Electrical data acc. to IEC 61984	5 A 50 V 0.8 kV 3
Rated current	5 A
Rated voltage	50 V
Rated impulse voltage	0.8 kV
Pollution degree	3
Insulation resistance	≥ 10 ¹⁰ Ohm
Limiting temperatures	-40 °C ... 85 °C
Flammability (insert) acc. to UL 94	V 0
Mating cycles	≥ 500
Material (insert)	polycarbonate
Colour (insert)	RAL 7032 (light grey)
Material (accessories)	metal

IEC 60664-1
IEC 61984



Number of contacts

2

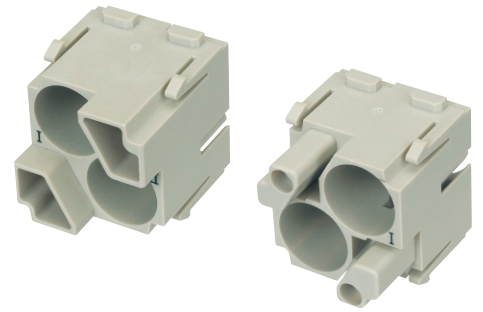

Identification	Wire gauge (mm ²)	Part number		Drawing	Dimensions in mm												
		male	female														
<p>Han-Modular®, Han-Quintax® module</p> <p>Crimp terminal</p>		09 14 002 3001	09 14 002 3101	<p>M</p> <p>F</p> <p>Contact arrangement (view from termination side)</p>													
<p>Han-Modular®, Han-Quintax® High Density contact</p> <p>8 + shielding, for Han® D-Sub contacts</p> <p>Please order contacts separately</p>		09 15 008 3013	09 15 008 3113	<p>M</p> <p>F</p>													
<p>Han-Quintax® Adapter</p> <p>optional</p>		09 14 000 9915	09 14 000 9915														
<p>Han® D-Sub crimp contact, turned contacts</p>	<p>0.09-0.25</p> <p>0.13-0.33</p> <p>0.25-0.52</p>	<p>09 67 000 7576</p> <p>09 67 000 5576</p> <p>09 67 000 8576</p>	<p>09 67 000 7476</p> <p>09 67 000 5476</p> <p>09 67 000 8476</p>	<table border="1"> <thead> <tr> <th>Wire gauge</th> <th>max. Insulation Ø</th> <th>Stripping length</th> </tr> </thead> <tbody> <tr> <td>0.09-0.25 mm²</td> <td>1.7 mm</td> <td>4 mm</td> </tr> <tr> <td>0.13-0.33 mm²</td> <td>1.7 mm</td> <td>4 mm</td> </tr> <tr> <td>0.25-0.52 mm²</td> <td>1.7 mm</td> <td>4 mm</td> </tr> </tbody> </table>	Wire gauge	max. Insulation Ø	Stripping length	0.09-0.25 mm ²	1.7 mm	4 mm	0.13-0.33 mm ²	1.7 mm	4 mm	0.25-0.52 mm ²	1.7 mm	4 mm	
Wire gauge	max. Insulation Ø	Stripping length															
0.09-0.25 mm ²	1.7 mm	4 mm															
0.13-0.33 mm ²	1.7 mm	4 mm															
0.25-0.52 mm ²	1.7 mm	4 mm															

Features

- Shielding bus separate from housing potential
- Suitable for the transmission of sensitive signals (e.g. bus signals)
- Usable for Gigabit Ethernet Cat. 6_A

Specifications / Approvals

IEC 60664-1
IEC 61984



Technical characteristics

Contacts	8
Electrical data acc. to IEC 61984	5 A 50 V 0.8 kV 3
Rated current	5 A
Rated voltage	50 V
Rated impulse voltage	0.8 kV
Pollution degree	3
Insulation resistance	≥ 10 ¹⁰ Ohm
Limiting temperatures	-40 °C ... 85 °C
Flammability (insert) acc. to UL 94	V 0
Mating cycles	≥ 500
Material (insert)	polycarbonate
Colour (insert)	RAL 7032 (light grey)
Material (shielding element)	zinc die-cast alloy
Material (outer conductor)	zinc alloy
Surface (outer conductor)	nickel plated contacts

Number of contacts

8

50 V
5 A
+ shielding



Identification	Wire gauge (mm ²)	Part number		Drawing	Dimensions in mm												
		male	female														
<p>Han-Modular®, Han® Gigabit Insert</p> <p>Crimp terminal Please order crimp contacts separately Please order the adapter module separately</p>		09 14 008 3011	09 14 008 3111	<p>M</p> <p>F</p> <p>Contact arrangement (view from termination side)</p>													
<p>Han-Modular®, Adapter module</p>		09 14 001 3011	09 14 001 3111	<p>M</p> <p>F</p>													
<p>Han® D-Sub crimp contact, turned contacts</p>	<p>0.09-0.25</p> <p>0.13-0.33</p> <p>0.25-0.52</p>	<p>09 67 000 7576</p> <p>09 67 000 5576</p> <p>09 67 000 8576</p>	<p>09 67 000 7476</p> <p>09 67 000 5476</p> <p>09 67 000 8476</p>	<table border="1"> <thead> <tr> <th>Wire gauge</th> <th>max. Insulation Ø</th> <th>Stripping length</th> </tr> </thead> <tbody> <tr> <td>0.09-0.25 mm²</td> <td>1.7 mm</td> <td>4 mm</td> </tr> <tr> <td>0.13-0.33 mm²</td> <td>1.7 mm</td> <td>4 mm</td> </tr> <tr> <td>0.25-0.52 mm²</td> <td>1.7 mm</td> <td>4 mm</td> </tr> </tbody> </table>	Wire gauge	max. Insulation Ø	Stripping length	0.09-0.25 mm ²	1.7 mm	4 mm	0.13-0.33 mm ²	1.7 mm	4 mm	0.25-0.52 mm ²	1.7 mm	4 mm	
Wire gauge	max. Insulation Ø	Stripping length															
0.09-0.25 mm ²	1.7 mm	4 mm															
0.13-0.33 mm ²	1.7 mm	4 mm															
0.25-0.52 mm ²	1.7 mm	4 mm															



Ha-VIS data bus cable
2-wire, elastic

Advantages

- Halogen free
- Electron-beam cross-linked cable
- Improved fire performance
- High resistance to temperature
- Conform to MVB standard according IEC 61375-3-1

Applications

For fixed and moveable installation inside of rail vehicles and buses. For symmetrical signal and data transmission with impedance of 120 Ohm. Suitable for use in MVB (Multifunction Vehicle Bus) as part of the TCN (Train Communication Network). Especially designed for termination with HARTING D-Sub InduCom and Han-Quintax® and other railway-specific Han® connectors and housings.

Features

- | | |
|-------------------------|---|
| • Sheath material | Elastomer,
electron beam cross-linked |
| • Category | MVB bus 120 Ω |
| • Number of wires | 2 and more pairs |
| • Wire design | 2 x 0.5 mm ² or higher number of pairs
on request |
| • Cable sheath diameter | 7.9 mm |



Ha-VIS data bus cable 2-wire, elastic

Identification

Part No.

Ha-VIS data bus cable 2-wire, elastic

Sheath material:
Elastomer, electron-beam cross-linked,
COMP 603
Colour: black

Nominal voltage: 300 V

Testing voltage:
Conductor/conductor 2 kV AC
Conductor/shielding 2 kV AC

Maximum conductor
resistance @ 20 °C: < 40.1 mΩ/m

Impedance @
0.75 – 3 MHz: 120 Ω ± 12 Ω

Transfer impedance
@ 20 MHz: ≤ 20 mΩ/m

Attenuation:
1 MHz: ≤ 12 dB/km
3 MHz: ≤ 17 dB/km
4 MHz: ≤ 22 dB/km

Maximum conductor temperature:
Fixed installed -40 °C ... +90 °C
Short circuit +160 °C

Minimum bending radius:
Fixed installed > 6 x diameter

Cable sheath diameter: (Ø 7.9 ± 0.2) mm

Cable weight: 85 kg/km

500 m drum

09 45 600 0270

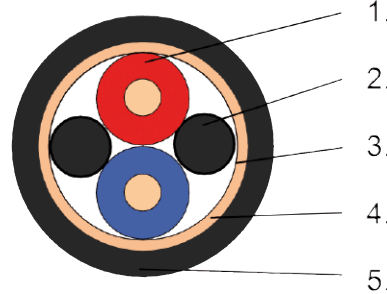

1. Pair

Conductor: tinned copper strands 0.5 mm² according to VDE 0295/IEC 60228 Class 5 construction 16 x 0.20 mm, Ø 0.85 mm

Insulation: Polyethylene (PE), cross-linked, Comp 655 Ø 2.85 mm

Colours: red, blue

2. Filler

3. Wrapping

Plastic tape

4. Shielding

Aluminium-bonded polyester tape with tinned fine copper braid, Ø 6.5 mm

5. Jacket

Elastomer electron-beam cross-linked Comp 603, Ø 7.9 mm
Colour: black



Ha-VIS data bus cable
2-wire, elastic

Advantages

- Halogen free
- Electron-beam cross-linked cable
- Improved fire performance
- High resistance to temperature
- Conform to UIC 558 standard
- Conform to WTB standard according IEC 61 375-2-1

Applications

For fixed and moveable installation inside of rail vehicles and buses. For symmetrical signal and data transmission with impedance of 120 Ohm. Suitable for use in WTB (Wire Train Bus) as part of the TCN (Train Communication Network) according UIC 558. Especially designed for termination with HARTING D-Sub InduCom and Han-Quintax® and other railway- specific Han® connectors and housings.

Features

- | | |
|-------------------------|--|
| • Sheath material | Elastomer,
electron beam cross-linked |
| • Category | WTB bus 120 Ω |
| • Number of wires | 2 and more pairs |
| • Wire design | 2 x 0.75 mm ² or higher number
of pairs on request |
| • Cable sheath diameter | 9.6 mm |



Ha-VIS data bus cable 2-wire, elastic

Identification

Part No.

Ha-VIS data bus cable 2-wire, elastic

Sheath material:
Elastomer, electron-beam cross-linked,
COMP 603
Colour: black

Nominal voltage: 300 V
Testing voltage:
Conductor/conductor 2 kV AC
Conductor/shielding 2 kV AC
Maximum conductor
resistance @ 20 °C: < 26.7 mΩ/m
Capacitance @ 1 MHz:
Railway cord/railway cord: < 65 pF/m
Railway cord/screen: < 120 pF/m
Impedance @
0.75 – 3 MHz: 120 Ω ± 12 Ω
Transfer impedance
@ 30 MHz: ≤ 30 mΩ/m
Attenuation:
1 MHz: ≤ 10 dB/km
4 MHz: ≤ 14 dB/km
5 MHz: ≤ 18 dB/km

Maximum conductor temperature:
Fixed installed -40 °C ... +90 °C
Short circuit +160 °C

Minimum bending radius:
Fixed installed > 6 x diameter

Cable sheath diameter: (Ø 9.6 ± 0.2) mm

Cable weight: 114 kg/km

500 m drum

09 45 600 0280

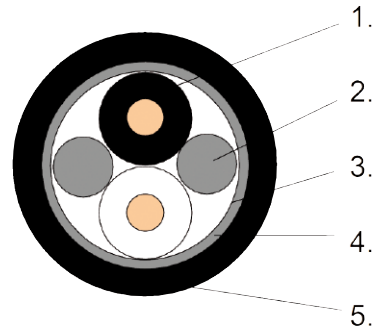

1. Pair

Conductor: tinned copper strands 0.75 mm² according to VDE 0295/IEC 60228 Class 5 construction 24 x 0.20 mm, Ø 1.1 mm
Insulation: Polyethylene (PE), cross-linked, Comp 655 Ø 3.7 mm
Colours: black, white

2. Filler

Polyolefine copolymer

3. Wrapping

Plastic tape

4. Shielding

Aluminium-bonded polyester tape with tinned fine copper braid, Ø 8.2 mm

5. Jacket

Elastomer electron-beam cross-linked Comp 603, Ø 9.6 mm
Colour: black



Ha-VIS data bus cable
2-wire, elastic, FOAM

Advantages

- Halogen free
- Electron-beam cross-linked cable
- Improved fire performance
- High resistance to temperature
- Conform to UIC 558 standard
- Conform to WTB standard according IEC 61 375-2-1

Applications

For fixed and moveable installation inside of rail vehicles and buses. For symmetrical signal and data transmission with impedance of 120 Ohm. Suitable for use in WTB (Wire Train Bus) as part of the TCN (Train Communication Network) according UIC 558.

Especially designed for termination with HARTING D-Sub InduCom and Han-Quintax® and other railway- specific Han® connectors and housings.

Features

- | | |
|-------------------------|--|
| • Sheath material | Elastomer,
electron beam cross-linked |
| • Category | WTB bus 120 ? |
| • Number of wires | 2 and more pairs |
| • Wire design | 2 x 0.75 mm ² or higher number of
pairs after request, FOAM insulation |
| • Cable sheath diameter | 8 mm |



Ha-VIS data bus cable 2-wire, elastic, FOAM

Identification

Part No.

Ha-VIS data bus cable 2-wire, elastic, FOAM

Sheath material:
Elastomer, electron-beam cross-linked,
COMP 603
Colour: black

Nominal voltage: 300 V
Testing voltage:
Conductor/conductor 1.5 kV AC
Conductor/shielding 1.5 kV AC
Maximum conductor
resistance @ 20 °C: < 26.7 mΩ/m
Capacitance @ 1 MHz:
Railway cord/railway cord: < 65 pF/m
Railway cord/screen: < 120 pF/m
Impedance @
0.75 – 3 MHz: 120 Ω ± 12 Ω
Transfer impedance
@ 30 MHz: ≤ 30 mΩ/m
Attenuation:
1 MHz: ≤ 10 dB/km
2 MHz: ≤ 14 dB/km

Maximum conductor temperature:
Fixed installed -25 °C ... +90 °C
Short circuit +100 °C

Minimum bending radius:
Fixed installed > 6 x diameter

Cable sheath diameter: (Ø 8.0 ± 0.2) mm

Cable weight: 79 kg/km

500 m drum 09 45 600 0181
1000 m drum 09 45 600 0191

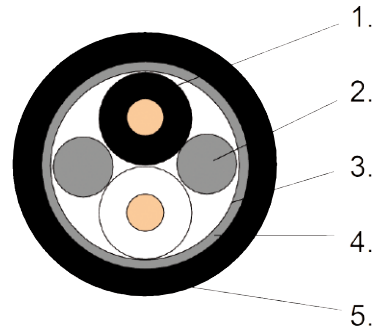

1. Pair

Conductor: tinned copper strands according to VDE 0295/IEC 60228 Class 5 construction 19 x 0.20 mm, Ø 1.1 mm
Insulation: FOAM-skin polyolefin, Ø 2.7 mm
Colours: black, white

2. Filler

Polyolefine copolymer

3. Wrapping

Plastic tape

4. Shielding

Tinned fine copper braid, Ø 6.4 mm

5. Jacket

Elastomer electron-beam cross-linked Comp 603, Ø 8.0 mm
Colour: black

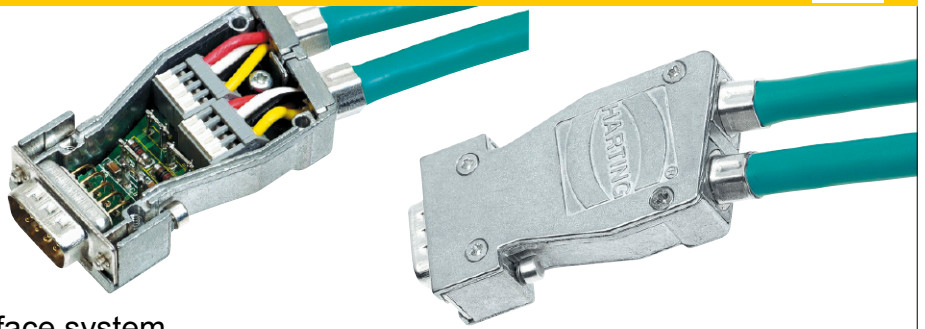

InduCom 9 – Industrial bus interface system

Identification

Part number

General information

MVB Interface

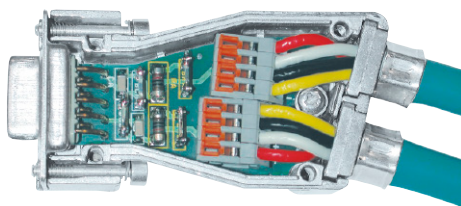

66 63 009 5013

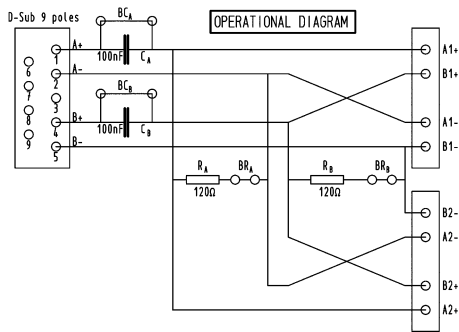

MVB backbone interface set

The Multifunctional Vehicle Bus (MVB) backbone interface is specially designed for communication cables in Train Control Networks (TCN). With this interface it is possible to realise a T-bus structure with MVB-cable with which you can disconnect the bus interface from the control unit without any interruption of the complete bus communication. On the PCB you will have load resistors and test capacitors which can be activated with solder bridges. The wires are terminated with the proven vibration resistant cage clamp technology.*

Components of the MVB interface set:

- 1 metal housing with 2 cable entries
- 2 hexagonal screws with UNC 4-40 threads
- 1 PCB with 9 way D-Sub male connector and cage clamps
- 2 crimp flanges for the MVB cable
- 2 crimp ferrules for the MVB cable
- 1 blanking piece

WTB Interface

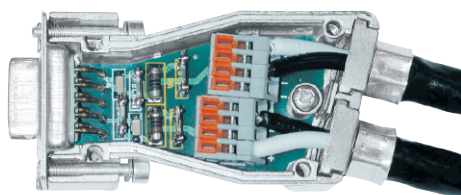

66 63 009 5014

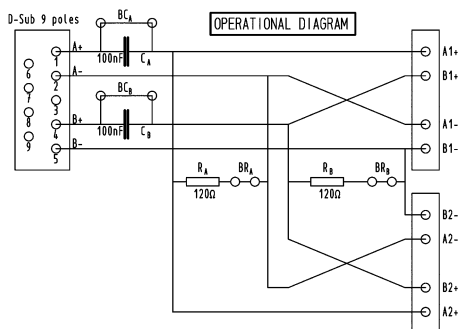

WTB backbone interface set

The Wired Train Bus (WTB) backbone interface is specially designed for backbone cables in Train Control Networks (TCN). With this interface it is possible to realise a T-bus structure with WTB-cable with which you can disconnect the bus interface from the control unit without any interruption of the complete bus communication. On the PCB you will have load resistors and test capacitors which can be activated with solder bridges. The wires are terminated with the proven vibration resistant cage clamp technology.*

Components of the MVB interface set:

- 1 metal housing with 2 cable entries
- 2 hexagonal screws with UNC 4-40 threads
- 1 PCB with 9 way D-Sub male connector and cage clamps
- 2 crimp flanges for the WTB cable
- 2 crimp ferrules for the WTB cable
- 1 blanking piece



Full metal top and side entry hoods with different screw options

Identification	No. of contacts	Part number	Drawing	Dimensions in mm																																				
40° side entry hood	9 15 25	61 03 001 . 013 61 03 001 . 014 61 03 001 . 015		<table border="1"> <thead> <tr> <th>No. of contacts</th> <th>A</th> <th>B</th> <th>C</th> <th>D</th> </tr> </thead> <tbody> <tr> <td>9</td> <td>31.0</td> <td>25.0</td> <td>35.0</td> <td>15.0</td> </tr> <tr> <td>15</td> <td>39.3</td> <td>33.3</td> <td>35.0</td> <td>15.0</td> </tr> <tr> <td>25</td> <td>53.0</td> <td>47.0</td> <td>35.0</td> <td>15.0</td> </tr> </tbody> </table>	No. of contacts	A	B	C	D	9	31.0	25.0	35.0	15.0	15	39.3	33.3	35.0	15.0	25	53.0	47.0	35.0	15.0																
					No. of contacts	A	B	C	D																															
9	31.0	25.0	35.0	15.0																																				
15	39.3	33.3	35.0	15.0																																				
25	53.0	47.0	35.0	15.0																																				
without internal grounding block	9	61 03 001 . 013 010																																						
Top/side entry hood	9 15 25 37 50	61 03 001 . 010 61 03 001 . 016 61 03 001 . 017 ¹⁾ 61 03 001 . 018 ¹⁾ 61 03 001 . 019 ¹⁾		<table border="1"> <thead> <tr> <th>No. of contacts</th> <th>No. of cable entries</th> <th>A</th> <th>B</th> <th>C</th> <th>D</th> </tr> </thead> <tbody> <tr> <td>9</td> <td>1 (top)</td> <td>31.0</td> <td>25.0</td> <td>38.0</td> <td>15.0</td> </tr> <tr> <td>15</td> <td>1 (top)</td> <td>39.5</td> <td>33.3</td> <td>35.0</td> <td>15.0</td> </tr> <tr> <td>25</td> <td>3</td> <td>53.0</td> <td>47.0</td> <td>43.0</td> <td>15.0</td> </tr> <tr> <td>37</td> <td>3</td> <td>69.5</td> <td>63.5</td> <td>43.0</td> <td>15.0</td> </tr> <tr> <td>50</td> <td>3</td> <td>67.2</td> <td>61.6</td> <td>43.0</td> <td>17.8</td> </tr> </tbody> </table>	No. of contacts	No. of cable entries	A	B	C	D	9	1 (top)	31.0	25.0	38.0	15.0	15	1 (top)	39.5	33.3	35.0	15.0	25	3	53.0	47.0	43.0	15.0	37	3	69.5	63.5	43.0	15.0	50	3	67.2	61.6	43.0	17.8
					No. of contacts	No. of cable entries	A	B	C	D																														
9	1 (top)	31.0	25.0	38.0	15.0																																			
15	1 (top)	39.5	33.3	35.0	15.0																																			
25	3	53.0	47.0	43.0	15.0																																			
37	3	69.5	63.5	43.0	15.0																																			
50	3	67.2	61.6	43.0	17.8																																			
without internal grounding block	9	61 03 001 . 010 010																																						
Please insert digit for screw option																																								
				<ul style="list-style-type: none"> Knurled screw, thread 4-40 UNC ▶ 0 Hexagonal screw, thread M3 with captive washer ▶ 1 Hexagonal screw, thread 4-40 UNC with captive washer ▶ 2 Knurled screw, thread M3 ▶ 3 																																				

¹⁾ Part number contains two blanking pieces
Operating temperature for all hoods on this page: -20 °C ... +90 °C



Full metal top and side entry hoods with different screw options

Identification	No. of contacts	Part number	Drawing	Dimensions in mm	
5° top entry hood with 3 cable entries with internal grounding block	37	61 03 001 . 118			
	50	61 03 001 . 119			
	without internal grounding block	37			61 03 001 . 118 010
		50			61 03 001 . 119 010
Please insert digit for screw option					
Knurled screw, thread 4-40 UNC ▶ 0					
Hexagonal screw, thread M3 with captive washer ▶ 1					
Hexagonal screw, thread 4-40 UNC with captive washer ▶ 2					
Knurled screw, thread M3 ▶ 3					
Top entry hood for InduCom 9				2 cable entries	
Hexagonal screw, thread 4-40 UNC	9	66 67 009 0346			
Hexagonal screw, thread M3	9	66 67 009 0347			

No. of contacts	A	B	C	D	E
37	69.5	52.0	58.2	14.8	63.5
50	67.1	58.0	63.6	17.6	61.1

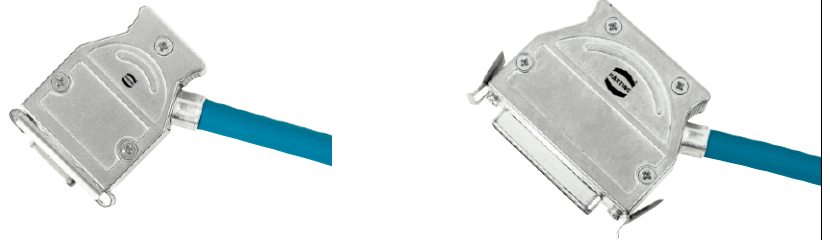

Full metal top and side entry hoods for spring or slide locking

Identification	No. of contacts	Part number	Drawing	Dimensions in mm
----------------	-----------------	-------------	---------	------------------

Top/side entry hood with spring/slide locking

9	61 03 001 0022 ¹⁾
15	61 03 001 0011 ²⁾
25	61 03 001 0012 ²⁾
37	61 03 001 0021 ²⁾
50	61 03 001 0020 ²⁾

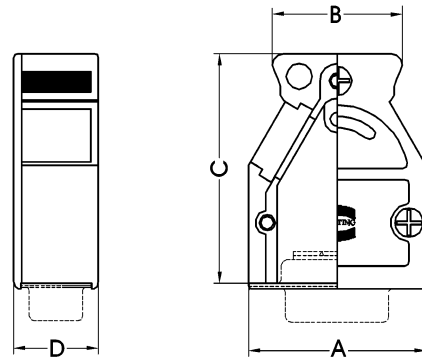

No. of contacts	No. of cable entries	A	B	C	D
9	2	31.0	22.6	40.0	14.8
15	3	39.0	30.6	40.0	14.8
25	3	53.0	42.6	40.0	14.8
37	3	69.5	59.2	40.0	14.8
50	3	67.0	55.0	40.0	17.6

¹⁾ Part number contains one blanking piece
²⁾ Part number contains two blanking pieces

Directory Chapter 06

Page

General information	06.03
System cable fibre optics	06.06
System cable PushPull V4 Industrial	06.12
System cable Han® 3 A LC duplex	06.22
System cable Han® 3 A LC duplex Hybrid	06.26
System cable SCRJ	06.30
System cable and connectors PushPull SCRJ	06.32
PushPull XS SFP	06.43
Expanded beam cable assemblies	06.47

In addition to classic copper cabling, HARTING offers a wide range of fibre optic (FO) cabling components and systems.

FO encompasses three types of cables:

- Multi-mode fibre optic cables and components
- Single-mode fibre optic cables and components
- Polymer optical fibres and components (POF)

While fibre optics can bridge very long distances (up to several kilometres), POF is often used for facilities and machinery construction applications which have an action radius of 50 metres.

POF components are also very quick and easy to assemble in the field, whereas glass fibre optic products often require expertise, care and special tools (splicers, special adhesive and grinding equipment, etc.).

The portfolio shown here includes:

- Fibre optic assemblies with LC, SC and ST connectors (IP20)
- Fibre optic assemblies with LC duplex connectors in HARTING PushPull V4 (IP65 / IP67)
- Fibre optic assemblies with LC duplex connectors in Han® 3 A (IP65 / IP67 / IP68)

- Hybrid cables and connectors in Han® 3 A (IP65 / IP67) with 2 x GF and 3 x 2.5 mm² copper each
- POF SCRJ system cables in IP20 and in Han® PushPull V14 in IP65 / IP67; PROFINET compliant
- PushPull XS SFP components

Fibre optic cables are much more sensitive overall than copper wires during their assembly, testing, routing (bending, torsion, tensile stress) and in operation (pressure sensitivity and temperature fluctuations).

They do, however, offer advantages in regards to their bandwidth/transfer rate, bridging distances (not limited to 100 m), and EMC behaviour (no shielding or grounding necessary).

This catalogue should not be used to find the optimal solution for a particular application. Recommendations can only be made.

HARTING HCS (<http://www.harting-customised-solutions.com/en/home/>) provides more help in developing customised solutions in the railway sector.

General

Apart from applications in the field of telecommunications, fibre optic technology is of great importance in the industrial market sector. In telecommunications there are requirements for:

- High transmission capacity
- Low cable attenuation
- No crosstalk

These features are also required in the industrial sector along with the following major considerations:

- Zero susceptibility to electromagnetic interference
- Electrical insulation between transmitter and receiver
- Small cable diameter

Fibre optic communication works by pulses of light. When feeding them in at one end of the fibre optic cable, the pulses are passed to the other end by total internal reflection.

Total internal reflection occurs at the boundary layer between core and cladding by virtue of the different values of optical refractive index (n) between the two materials (n cladding less than n core).

There are three different types of optical fibres:

		Typical Dimensions Core/ Cladding Ø	Attenuation
Step index (SI) fibre HCS ^{® 1)} /POF ²⁾		200/230 µm	5 dB/km ... 8 dB/km 0.2 dB/km
Gradient index(GI) fibre		50 /125 µm	2.6 dB/km 3.2 dB/km
Single modem fibre		9/125 µm	< 0.3 dB/km

optical refractive index profile

The single modem fibre is mainly used in telecommunications because of its low attenuation and wide band-width.

The gradient index fibre and the step fibre with their large core diameters are chiefly used as communication cables in industrial applications due to their easy handling and relatively low costs. The link length ranges from several meters to several kilometers.

Mounting of connectors for gradient fibres is achieved by the use of adhesive.

For POF²⁾ or HCS^{® 1)} fibres, the crimping technique eases the connector attachment.

With the advanced HARTING quick assembly components, POF-cables can be mounted without the need of special tools. HARTING F.O. systems are designed for gradient index fibres with a core diameter of 50 and 62.5 µm as well as for 200 µm (HCS^{® 1)}) and 1 mm (POF²⁾) step index fibres.

The typical operating wavelengths are 660 nm (POF²⁾, HCS^{® 1)}), 850 nm (GI, HCS^{® 1)}) and 1300 nm (GI).

¹⁾ HCS[®] (=Hard Clad Silica) is registered trade mark of SpecTran Corporation
²⁾ POF = Polymer Optical Fibre

Dimensioning of F.O. Transmission Systems

For reliable operation of a F.O. data transmission system it is essential that the transmitted optical signals arrive at the receiver with sufficient amplitude. The incident power should at least exceed twice (+ 3 dB) the value of the minimum sensitivity of the receiver. Otherwise, the inherent noise of the system may result in increasing randomly distributed transmission errors in the data transfer. Therefore, in system design the power budget of the optical path has to be checked. The following aspects have to be considered:

- Optical power output of the transmitter
The optical power generated by the LED does mainly depend on the applied forward current. Typical power levels coupled into the core are:

for glass-fibre ($\lambda = 850 \text{ nm}$):	
50/ 125 μm GI fibre:	80 μW
200/ 230 μm SI fibre:	250 μW
for Polymer fibre ($\lambda = 660 \text{ nm}$):	
980/1000 μm :	600 μW

- Specific attenuation-coefficient of the fibre
The specific attenuation of optical fibres depends on the wavelength applied and is specified in dB/km. Typical values are:

for glass-fibres ($\lambda = 850 \text{ nm}$):	
50/ 125 μm GI fibre:	---3 dB/km
200/ 230 μm HCS:	---5 dB/km
for polymer fibre ($\lambda = 660 \text{ nm}$):	
980/1000 μm (PMMA):	---0.2 dB/m

The fibre loss usually contributes to the highest amount to the overall transmission index of the optical link.

- Additional interconnections in the cable system
Interconnections in the optical link create some further attenuation for the travelling optical signals. Typical insertion loss is
 - for a spliced connection $\leq 0.3 \text{ dB}$
 - for a connector-set $0.8 \text{ dB} \dots 0.5 \text{ dB}$ depending on the type of fibre and the connectors applied.
- Sensitivity of the optical receiver DC-coupled optical receivers, commonly used, with SI-diodes as receiving elements show typical minimum sensitivities of
 - $\leq 3 \mu\text{W}$ @ 850 nm (glass fibre systems)
 - $\leq 5 \mu\text{W}$ @ 660 nm (polymer fibre systems)
- Temperature dependence and ageing of LED, thermal influence on cable loss
These items should be taken into account with an amount of 2 dB. Thus, in total a system reserve of 5 dB has to be considered in the link power budget.

Examples

a) Glass fibre system ($\lambda = 850 \text{ nm}$)

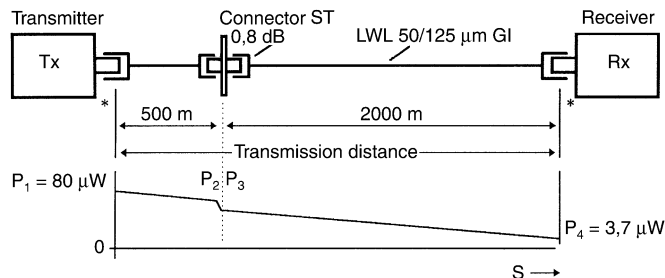

Link budget analysis:

Transmitter:
 $P_1 = 80 \mu\text{W} = -11 \text{ dBm}$
 power coupled into fibre core
 Cable Loss: $2.5 \text{ km} \times 3 \text{ dB/km} = 7.5 \text{ dB}$
 Loss per connector set ST = 0.8 dB
 System reserves (3 dB + 2 dB) = 5.0 dB
 Total system losses: **13.3 dB**

Incident power at receiver: $P_4 = -24.3 \text{ dBm} = 3.7 \mu\text{W}$

This satisfies the required minimum-conditions $\geq 3 \mu\text{W}$

* The injection- and decoupling-loss at the transmitter- and receiver-ends of the fibre has not additionally to be taken into account as they are already included in the given power ratings of these elements.

b) Polymer fibre system ($\lambda = 660 \text{ nm}$)

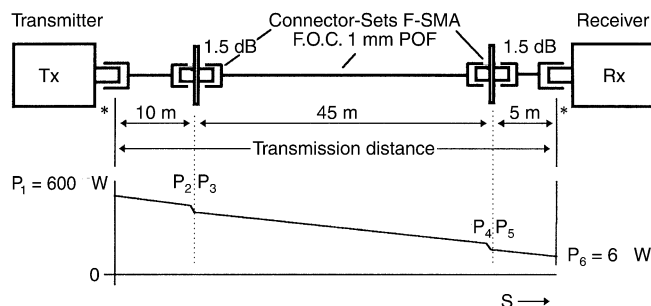

Link budget analysis:

Transmitter:
 $P_1 = 600 \mu\text{W} = -2.2 \text{ dBm}$
 power coupled into fibre core
 Cable loss: $60 \text{ m} \times 0.2 \text{ dB/m} = 12 \text{ dB}$
 2 connector-sets F-SMA (2 x 1.5 dB) = 3.0 dB
 System reserves (3 dB + 2 dB) = 5.0 dB
 Total system losses: **20.0 dB**

Incident power at receiver:

$P_6 = -22.2 \text{ dBm} = 6.0 \mu\text{W}$

This satisfies the required minimum-conditions $\geq 5 \mu\text{W}$

Omitting the additional interconnections in the cable (here e.g. the 2 F-SMA connector sets) results in larger maximum transmission distances.

Conversion Diagram

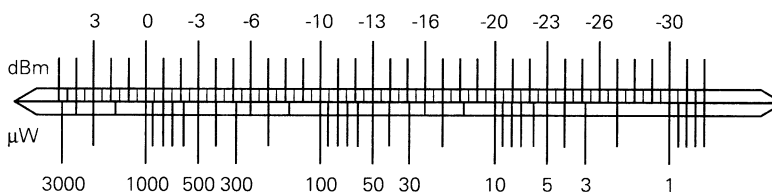

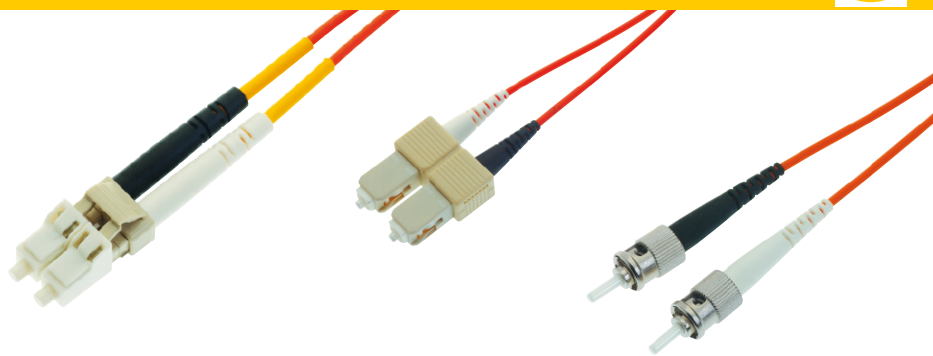

System cable fibre optics

Features

- Connector types LC/SC/ST
- Type of core Single and multi mode
- Number of cores 2
- Wiring Crossed (boot marking)
- Sheath material LSZH

Advantages

- Transmission of up to 10 Gbit/s
- Flexible, space saving
- Verified after assembling
- Halogen free and RoHS compliant
- Compliant acc. ISO/IEC 11801

Applications

- Industrial cabling
- Within switch cabinets
- In IT Networks

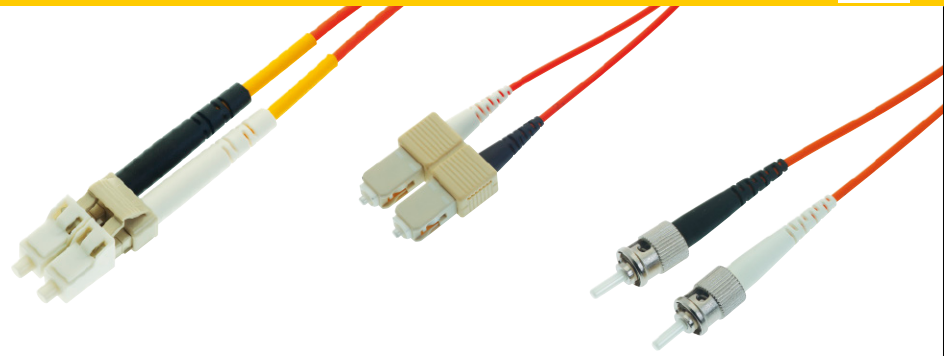

System cable fibre optics

Identification	Part number	Drawing	Dimensions in mm
<p>Jumper cable 2 x LC duplex multi mode 50/125 µm</p> <p>Length: a = 1 m a = 2 m a = 3 m a = 4 m a = 5 m a = 6 m a = 7 m a = 8 m a = 9 m a = 10 m</p>	<p>33 01 241 0010 005 33 01 241 0020 005 33 01 241 0030 005 33 01 241 0040 005 33 01 241 0050 005 33 01 241 0060 005 33 01 241 0070 005 33 01 241 0080 005 33 01 241 0090 005 33 01 241 0100 005</p>		
<p>Jumper cable 2 x SC duplex multi mode 50/125 µm</p> <p>Length: a = 1 m a = 2 m a = 3 m a = 4 m a = 5 m a = 6 m a = 7 m a = 8 m a = 9 m a = 10 m</p>	<p>33 01 241 0010 006 33 01 241 0020 006 33 01 241 0030 006 33 01 241 0040 006 33 01 241 0050 006 33 01 241 0060 006 33 01 241 0070 006 33 01 241 0080 006 33 01 241 0090 006 33 01 241 0100 006</p>		
<p>Jumper cable 2 x ST duplex multi mode 50/125 µm</p> <p>Length: a = 1 m a = 2 m a = 3 m a = 4 m a = 5 m a = 6 m a = 7 m a = 8 m a = 9 m a = 10 m</p>	<p>33 01 241 0010 007 33 01 241 0020 007 33 01 241 0030 007 33 01 241 0040 007 33 01 241 0050 007 33 01 241 0060 007 33 01 241 0070 007 33 01 241 0080 007 33 01 241 0090 007 33 01 241 0100 007</p>		

Other cable lengths on request

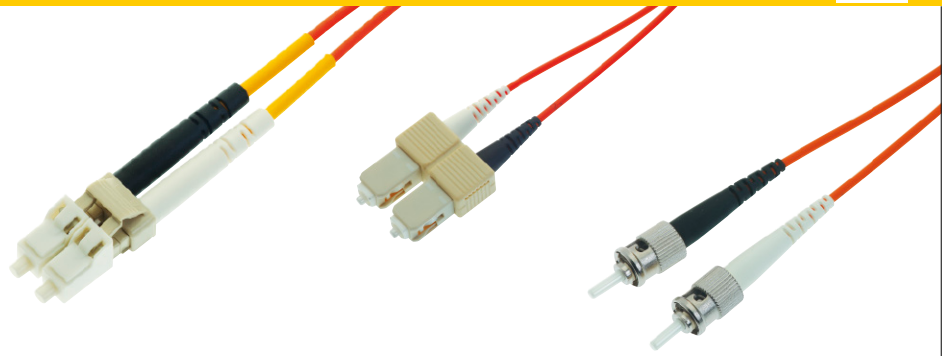

System cable fibre optics

Identification	Part number	Drawing	Dimensions in mm
----------------	-------------	---------	------------------

Adapter cable

SC duplex – LC duplex
multi mode 50/125 µm

- Length: a = 1 m
 a = 2 m
 a = 3 m
 a = 4 m
 a = 5 m
 a = 6 m
 a = 7 m
 a = 8 m
 a = 9 m
 a = 10 m

- 33 01 241 0010 034
 33 01 241 0020 034
 33 01 241 0030 034
 33 01 241 0040 034
 33 01 241 0050 034
 33 01 241 0060 034
 33 01 241 0070 034
 33 01 241 0080 034
 33 01 241 0090 034
 33 01 241 0100 034

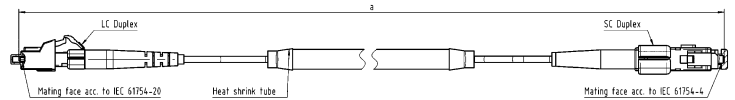

Adapter cable

SC duplex – LC duplex
multi mode 50/125 µm OM3

- Length: a = 1 m
 a = 2 m
 a = 3 m
 a = 4 m
 a = 5 m
 a = 6 m
 a = 7 m
 a = 8 m
 a = 9 m
 a = 10 m

- 33 01 241 0010 027
 33 01 241 0020 027
 33 01 241 0030 027
 33 01 241 0040 027
 33 01 241 0050 027
 33 01 241 0060 027
 33 01 241 0070 027
 33 01 241 0080 027
 33 01 241 0090 027
 33 01 241 0100 027

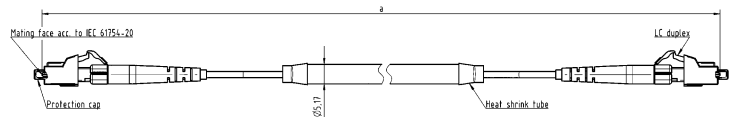

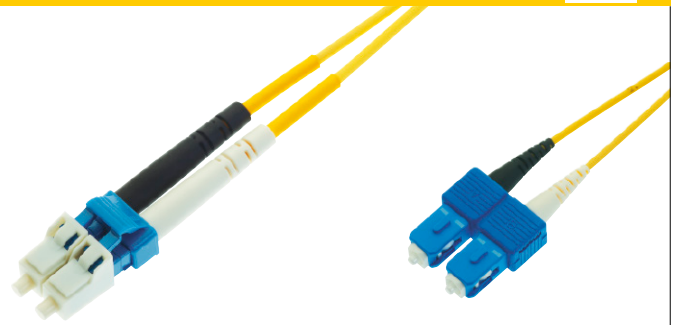

System cable fibre optics

Features

- Connector types LC/SC/ST
- Type of core Single and multi mode
- Number of cores 2
- Wiring Crossed (boot marking)
- Sheath material LSZH

Advantages

- Transmission of up to 10 Gbit/s
- Flexible, space saving
- Verified after assembling
- Halogen free and RoHS compliant
- Compliant acc. ISO/IEC 11801

Applications

- Industrial cabling
- Within switch cabinets
- In IT Networks

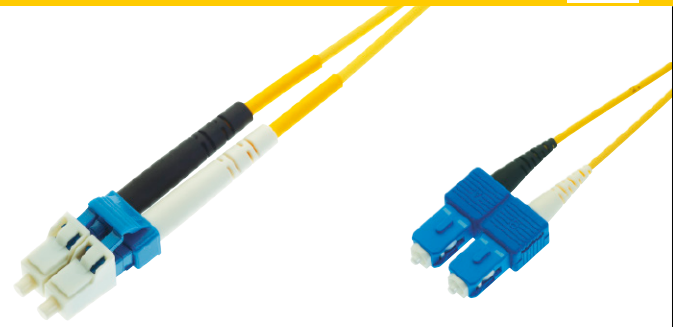

System cable fibre optics

Identification	Part number	Drawing	Dimensions in mm
Jumper cable 2 x LC duplex single mode 9/125 μm Length: a = 1 m a = 2 m a = 3 m a = 4 m a = 5 m a = 6 m a = 7 m a = 8 m a = 9 m a = 10 m	33 01 241 0010 008 33 01 241 0020 008 33 01 241 0030 008 33 01 241 0040 008 33 01 241 0050 008 33 01 241 0060 008 33 01 241 0070 008 33 01 241 0080 008 33 01 241 0090 008 33 01 241 0100 008		
Jumper cable 2 x SC duplex single mode 9/125 μm Length: a = 1 m a = 2 m a = 3 m a = 4 m a = 5 m a = 6 m a = 7 m a = 8 m a = 9 m a = 10 m	33 01 241 0010 009 33 01 241 0020 009 33 01 241 0030 009 33 01 241 0040 009 33 01 241 0050 009 33 01 241 0060 009 33 01 241 0070 009 33 01 241 0080 009 33 01 241 0090 009 33 01 241 0100 009		
Adapter cable SC duplex – LC duplex single mode 9/125 μm Length: a = 1 m a = 2 m a = 3 m a = 4 m a = 5 m a = 6 m a = 7 m a = 8 m a = 9 m a = 10 m	33 01 241 0010 033 33 01 241 0020 033 33 01 241 0030 033 33 01 241 0040 033 33 01 241 0050 033 33 01 241 0060 033 33 01 241 0070 033 33 01 241 0080 033 33 01 241 0090 033 33 01 241 0100 033		

Other cable lengths on request



Features

• Connector types	PushPull V4
• Type of core	Single and multi mode
• Number of cores	2
• Wiring	Crossed
• Sheath material	PUR
• Degree of protection	IP68
• Temperature range	-40 °C ... +85 °C

Advantages

- Transmission of up to 10 Gbit/s
- Flexible, space saving
- Simple handling by HARTING PushPull
- Suitable for outdoor application

Applications

- Industrial cabling
- Outdoor installation
- Antenna cabling



Identification	Part number	Drawing	Dimensions in mm
<p>Fibre optic cable, double ended, PushPull V4, single mode overmoulded</p> <p>Length: a = 1 m</p> <p>a = 2 m</p> <p>a = 3 m</p> <p>a = 4 m</p> <p>a = 5 m</p> <p>a = 6 m</p> <p>a = 7 m</p> <p>a = 8 m</p> <p>a = 9 m</p> <p>a = 10 m</p> <p>a = 11 m</p> <p>a = 12 m</p> <p>a = 13 m</p> <p>a = 14 m</p> <p>a = 15 m</p> <p>a = 20 m</p> <p>a = 25 m</p> <p>a = 30 m</p> <p>a = 35 m</p> <p>a = 40 m</p> <p>a = 45 m</p> <p>a = 50 m</p> <p>a = 60 m</p> <p>a = 70 m</p> <p>a = 80 m</p> <p>a = 90 m</p> <p>a = 100 m</p>	<p>33 61 221 0010 001</p> <p>33 61 221 0020 001</p> <p>33 61 221 0030 001</p> <p>33 61 221 0040 001</p> <p>33 61 221 0050 001</p> <p>33 61 221 0060 001</p> <p>33 61 221 0070 001</p> <p>33 61 221 0080 001</p> <p>33 61 221 0090 001</p> <p>33 61 221 0100 001</p> <p>33 61 221 0110 001</p> <p>33 61 221 0120 001</p> <p>33 61 221 0130 001</p> <p>33 61 221 0140 001</p> <p>33 61 221 0150 001</p> <p>33 61 221 0200 001</p> <p>33 61 221 0250 001</p> <p>33 61 221 0300 001</p> <p>33 61 221 0350 001</p> <p>33 61 221 0400 001</p> <p>33 61 221 0450 001</p> <p>33 61 221 0500 001</p> <p>33 61 221 0600 001</p> <p>33 61 221 0700 001</p> <p>33 61 221 0800 001</p> <p>33 61 221 0900 001</p> <p>33 61 221 1000 001</p>	<p>a = length</p> <p> X (without dust cap) Y (without dust cap) </p> <p> Loading-Plan A — fiber 1 — B B — fiber 2 — A </p>	
<p>Fibre optic breakout cable, single mode</p> <p>Length: 10 m</p> <p>Length: 20 m</p> <p>Length: 100 m</p>	<p>33 58 751 0100 002</p> <p>33 58 751 0200 002</p> <p>33 58 751 1000 002</p>	<p> PUR jacket 2-fibre single mode Outer diameter: 6.5 mm Min. bending radius: 10.4 cm Installation: 10.4 cm Operating: 5.2 cm </p>	



Identification

Part number

Drawing

Dimensions in mm

Fibre optic cable, double ended, PushPull V4, multi mode, 50 / 125 µm, OM3 overmoulded

Length:	a =	Part number
	1 m	33 61 221 0010 002
	2 m	33 61 221 0020 002
	3 m	33 61 221 0030 002
	4 m	33 61 221 0040 002
	5 m	33 61 221 0050 002
	6 m	33 61 221 0060 002
	7 m	33 61 221 0070 002
	8 m	33 61 221 0080 002
	9 m	33 61 221 0090 002
	10 m	33 61 221 0100 002
	11 m	33 61 221 0110 002
	12 m	33 61 221 0120 002
	13 m	33 61 221 0130 002
	14 m	33 61 221 0140 002
	15 m	33 61 221 0150 002
	20 m	33 61 221 0200 002
	25 m	33 61 221 0250 002
	30 m	33 61 221 0300 002
	35 m	33 61 221 0350 002
	40 m	33 61 221 0400 002
	45 m	33 61 221 0450 002
	50 m	33 61 221 0500 002
	60 m	33 61 221 0600 002
	70 m	33 61 221 0700 002
	80 m	33 61 221 0800 002
	90 m	33 61 221 0900 002
	100 m	33 61 221 1000 002

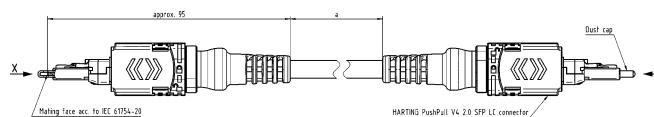

a = length

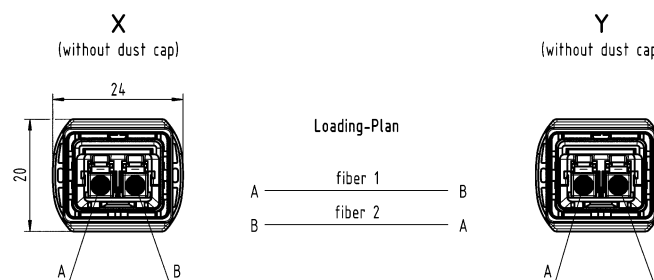

Fibre optic breakout cable, multi mode, 50 / 125 µm, OM3

Length:	Part number
10 m	33 58 751 0100 003
20 m	33 58 751 0200 003
100 m	33 58 751 1000 003

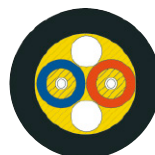

PUR jacket
 2-fibre multi mode 50 µm
 Outer diameter: 6.5 mm
 Min. bending radius:
 Installation: 10.4 cm
 Operating: 5.2 cm



Identification	Part number	Drawing	Dimensions in mm
<p>Fibre optic cable, double ended, PushPull V4, multi mode, 62.5 µm overmoulded</p> <p>Length: a = 1 m</p> <p>a = 2 m</p> <p>a = 3 m</p> <p>a = 4 m</p> <p>a = 5 m</p> <p>a = 6 m</p> <p>a = 7 m</p> <p>a = 8 m</p> <p>a = 9 m</p> <p>a = 10 m</p> <p>a = 11 m</p> <p>a = 12 m</p> <p>a = 13 m</p> <p>a = 14 m</p> <p>a = 15 m</p> <p>a = 20 m</p> <p>a = 25 m</p> <p>a = 30 m</p> <p>a = 35 m</p> <p>a = 40 m</p> <p>a = 45 m</p> <p>a = 50 m</p> <p>a = 60 m</p> <p>a = 70 m</p> <p>a = 80 m</p> <p>a = 90 m</p> <p>a = 100 m</p>	<p>33 61 221 0010 003</p> <p>33 61 221 0020 003</p> <p>33 61 221 0030 003</p> <p>33 61 221 0040 003</p> <p>33 61 221 0050 003</p> <p>33 61 221 0060 003</p> <p>33 61 221 0070 003</p> <p>33 61 221 0080 003</p> <p>33 61 221 0090 003</p> <p>33 61 221 0100 003</p> <p>33 61 221 0110 003</p> <p>33 61 221 0120 003</p> <p>33 61 221 0130 003</p> <p>33 61 221 0140 003</p> <p>33 61 221 0150 003</p> <p>33 61 221 0200 003</p> <p>33 61 221 0250 003</p> <p>33 61 221 0300 003</p> <p>33 61 221 0350 003</p> <p>33 61 221 0400 003</p> <p>33 61 221 0450 003</p> <p>33 61 221 0500 003</p> <p>33 61 221 0600 003</p> <p>33 61 221 0700 003</p> <p>33 61 221 0800 003</p> <p>33 61 221 0900 003</p> <p>33 61 221 1000 003</p>	<p>a = length</p> <p> X (without dust cap) Y (without dust cap) </p> <p> Loading-Plan A — fiber 1 — B B — fiber 2 — A </p>	
<p>Fibre optic breakout cable, multi mode, 62.5 µm</p> <p>Length: 10 m</p> <p>Length: 20 m</p> <p>Length: 100 m</p>	<p>33 58 751 0100 001</p> <p>33 58 751 0200 001</p> <p>33 58 751 1000 001</p>	<p> PUR jacket 2-fibre multi mode 62.5 µm Outer diameter: 7 mm Min. bending radius: Installation: 10.5 cm Operating: 7.0 cm </p>	



Identification

Part number

Drawing

Dimensions in mm

Fibre optic cable,
PushPull V4 – LC duplex,
single mode
overmoulded

Length: a = 1 m	33 61 431 0010 001
a = 2 m	33 61 431 0020 001
a = 3 m	33 61 431 0030 001
a = 4 m	33 61 431 0040 001
a = 5 m	33 61 431 0050 001
a = 6 m	33 61 431 0060 001
a = 7 m	33 61 431 0070 001
a = 8 m	33 61 431 0080 001
a = 9 m	33 61 431 0090 001
a = 10 m	33 61 431 0100 001
a = 11 m	33 61 431 0110 001
a = 12 m	33 61 431 0120 001
a = 13 m	33 61 431 0130 001
a = 14 m	33 61 431 0140 001
a = 15 m	33 61 431 0150 001
a = 20 m	33 61 431 0200 001
a = 25 m	33 61 431 0250 001
a = 30 m	33 61 431 0300 001
a = 35 m	33 61 431 0350 001
a = 40 m	33 61 431 0400 001
a = 45 m	33 61 431 0450 001
a = 50 m	33 61 431 0500 001
a = 60 m	33 61 431 0600 001
a = 70 m	33 61 431 0700 001
a = 80 m	33 61 431 0800 001
a = 90 m	33 61 431 0900 001
a = 100 m	33 61 431 1000 001

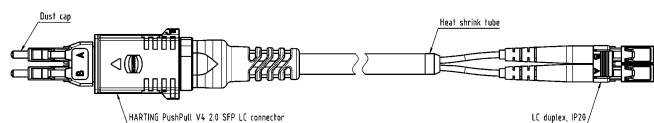

a = length

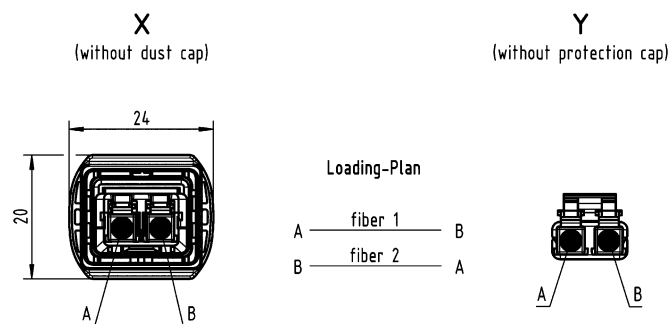

Fibre optic breakout cable,
single mode

Length: 10 m	33 58 751 0100 002
Length: 20 m	33 58 751 0200 002
Length: 100 m	33 58 751 1000 002

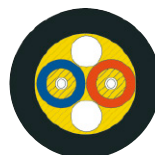

PUR jacket
2-fibre single mode
Outer diameter: 6.5 mm
Min. bending radius:
Installation: 10.4 cm
Operating: 5.2 cm



Identification	Part number	Drawing	Dimensions in mm
<p>Fibre optic cable, double ended, PushPull V4 – LC duplex, multi mode, 50 / 125 µm, OM3 overmoulded</p> <p>Length: a = 1 m</p> <p>a = 2 m</p> <p>a = 3 m</p> <p>a = 4 m</p> <p>a = 5 m</p> <p>a = 6 m</p> <p>a = 7 m</p> <p>a = 8 m</p> <p>a = 9 m</p> <p>a = 10 m</p> <p>a = 11 m</p> <p>a = 12 m</p> <p>a = 13 m</p> <p>a = 14 m</p> <p>a = 15 m</p> <p>a = 20 m</p> <p>a = 25 m</p> <p>a = 30 m</p> <p>a = 35 m</p> <p>a = 40 m</p> <p>a = 45 m</p> <p>a = 50 m</p> <p>a = 60 m</p> <p>a = 70 m</p> <p>a = 80 m</p> <p>a = 90 m</p> <p>a = 100 m</p>	<p>33 61 431 0010 002</p> <p>33 61 431 0020 002</p> <p>33 61 431 0030 002</p> <p>33 61 431 0040 002</p> <p>33 61 431 0050 002</p> <p>33 61 431 0060 002</p> <p>33 61 431 0070 002</p> <p>33 61 431 0080 002</p> <p>33 61 431 0090 002</p> <p>33 61 431 0100 002</p> <p>33 61 431 0110 002</p> <p>33 61 431 0120 002</p> <p>33 61 431 0130 002</p> <p>33 61 431 0140 002</p> <p>33 61 431 0150 002</p> <p>33 61 431 0200 002</p> <p>33 61 431 0250 002</p> <p>33 61 431 0300 002</p> <p>33 61 431 0350 002</p> <p>33 61 431 0400 002</p> <p>33 61 431 0450 002</p> <p>33 61 431 0500 002</p> <p>33 61 431 0600 002</p> <p>33 61 431 0700 002</p> <p>33 61 431 0800 002</p> <p>33 61 431 0900 002</p> <p>33 61 431 1000 002</p>	<p>a = length</p> <p>X (without dust cap)</p> <p>Y (without protection cap)</p> <p>Loading-Plan</p> <p>A — fiber 1 — B</p> <p>B — fiber 2 — A</p>	
<p>Fibre optic breakout cable, multi mode, 50 / 125 µm, OM3</p> <p>Length: 10 m</p> <p>Length: 20 m</p> <p>Length: 100 m</p>	<p>33 58 751 0100 003</p> <p>33 58 751 0200 003</p> <p>33 58 751 1000 003</p>	<p>PUR jacket</p> <p>2-fibre multi mode 50 µm</p> <p>Outer diameter: 6.5 mm</p> <p>Min. bending radius:</p> <p>Installation: 10.4 cm</p> <p>Operating: 5.2 cm</p>	



Identification	Part number	Drawing	Dimensions in mm
----------------	-------------	---------	------------------

Fibre optic cable,
PushPull V4 – LC duplex,
multi mode, 62.5 / 125 µm
overmoulded

Length: a = 1 m	33 61 431 0010 003
a = 2 m	33 61 431 0020 003
a = 3 m	33 61 431 0030 003
a = 4 m	33 61 431 0040 003
a = 5 m	33 61 431 0050 003
a = 6 m	33 61 431 0060 003
a = 7 m	33 61 431 0070 003
a = 8 m	33 61 431 0080 003
a = 9 m	33 61 431 0090 003
a = 10 m	33 61 431 0100 003
a = 11 m	33 61 431 0110 003
a = 12 m	33 61 431 0120 003
a = 13 m	33 61 431 0130 003
a = 14 m	33 61 431 0140 003
a = 15 m	33 61 431 0150 003
a = 20 m	33 61 431 0200 003
a = 25 m	33 61 431 0250 003
a = 30 m	33 61 431 0300 003
a = 35 m	33 61 431 0350 003
a = 40 m	33 61 431 0400 003
a = 45 m	33 61 431 0450 003
a = 50 m	33 61 431 0500 003
a = 60 m	33 61 431 0600 003
a = 70 m	33 61 431 0700 003
a = 80 m	33 61 431 0800 003
a = 90 m	33 61 431 0900 003
a = 100 m	33 61 431 1000 003

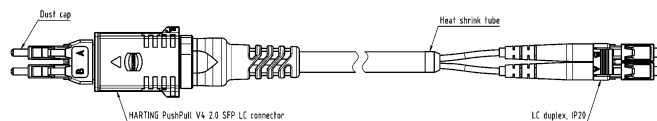

a = length

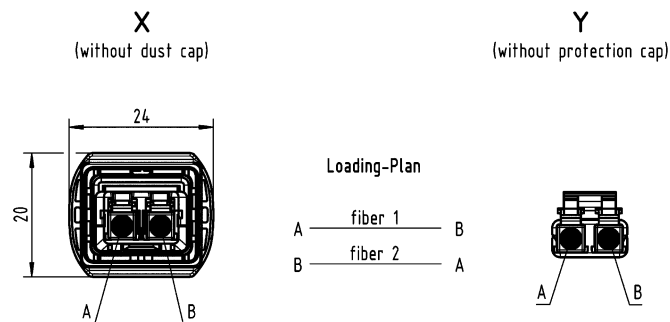

Fibre optic breakout cable,
multi mode, 62.5 / 125 µm

Length: 10 m	33 58 751 0100 001
Length: 20 m	33 58 751 0200 001
Length: 100 m	33 58 751 1000 001

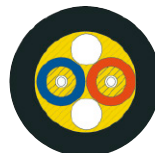

PUR jacket
2-fibre multi mode 62.5 µm
Outer diameter: 7 mm
Min. bending radius:
Installation: 10.5 cm
Operating: 7.0 cm



Identification	Part number	Drawing	Dimensions in mm				
Fibre optic cable, PushPull V4 – SC duplex, single mode overmoulded Length: a = 1 m a = 2 m a = 3 m a = 4 m a = 5 m a = 6 m a = 7 m a = 8 m a = 9 m a = 10 m a = 11 m a = 12 m a = 13 m a = 14 m a = 15 m a = 20 m a = 25 m a = 30 m a = 35 m a = 40 m a = 45 m a = 50 m a = 60 m a = 70 m a = 80 m a = 90 m a = 100 m	33 61 431 0010 004 33 61 431 0020 004 33 61 431 0030 004 33 61 431 0040 004 33 61 431 0050 004 33 61 431 0060 004 33 61 431 0070 004 33 61 431 0080 004 33 61 431 0090 004 33 61 431 0100 004 33 61 431 0110 004 33 61 431 0120 004 33 61 431 0130 004 33 61 431 0140 004 33 61 431 0150 004 33 61 431 0200 004 33 61 431 0250 004 33 61 431 0300 004 33 61 431 0350 004 33 61 431 0400 004 33 61 431 0450 004 33 61 431 0500 004 33 61 431 0600 004 33 61 431 0700 004 33 61 431 0800 004 33 61 431 0900 004 33 61 431 1000 004	<p>a = length</p> <p>X (without dust cap)</p> <p>Y (without dust cap)</p> <p>24</p> <p>20</p> <p>A B</p> <p>A B</p> <p>Loading-Plan</p> <p>A — fiber 1 — B</p> <p>B — fiber 2 — A</p>					
				Fibre optic breakout cable, single mode Length: 10 m Length: 20 m Length: 100 m	33 58 751 0100 002 33 58 751 0200 002 33 58 751 1000 002	<p>PUR jacket 2-fibre single mode Outer diameter: 6.5 mm Min. bending radius: 10.4 cm Installation: 10.4 cm Operating: 5.2 cm</p>	Fibre optic cords

Other cable lengths on request



Identification

Part number

Drawing

Dimensions in mm

Fibre optic cable, double ended,
PushPull V4 – SC duplex,
multi mode, 50 / 125 µm, OM3
overmoulded

Length: a = 1 m	33 61 431 0010 005
a = 2 m	33 61 431 0020 005
a = 3 m	33 61 431 0030 005
a = 4 m	33 61 431 0040 005
a = 5 m	33 61 431 0050 005
a = 6 m	33 61 431 0060 005
a = 7 m	33 61 431 0070 005
a = 8 m	33 61 431 0080 005
a = 9 m	33 61 431 0090 005
a = 10 m	33 61 431 0100 005
a = 11 m	33 61 431 0110 005
a = 12 m	33 61 431 0120 005
a = 13 m	33 61 431 0130 005
a = 14 m	33 61 431 0140 005
a = 15 m	33 61 431 0150 005
a = 20 m	33 61 431 0200 005
a = 25 m	33 61 431 0250 005
a = 30 m	33 61 431 0300 005
a = 35 m	33 61 431 0350 005
a = 40 m	33 61 431 0400 005
a = 45 m	33 61 431 0450 005
a = 50 m	33 61 431 0500 005
a = 60 m	33 61 431 0600 005
a = 70 m	33 61 431 0700 005
a = 80 m	33 61 431 0800 005
a = 90 m	33 61 431 0900 005
a = 100 m	33 61 431 1000 005

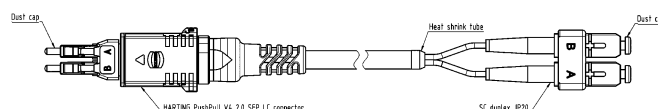

a = length

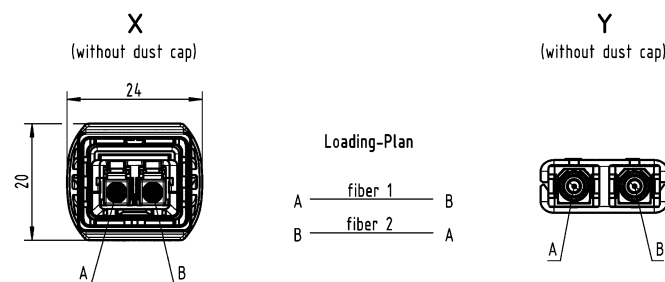

Fibre optic
cords

Fibre optic breakout cable,
multi mode, 50 / 125 µm, OM3

Length: 10 m	33 58 751 0100 003
Length: 20 m	33 58 751 0200 003
Length: 100 m	33 58 751 1000 003

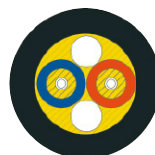

PUR jacket
2-fibre multi mode 50 µm
Outer diameter: 6.5 mm
Min. bending radius:
Installation: 10.4 cm
Operating: 5.2 cm



Identification	Part number	Drawing	Dimensions in mm
----------------	-------------	---------	------------------

Fibre optic cable,
PushPull V4 – SC duplex,
multi mode, 62.5 / 125 µm
overmoulded

Length: a = 1 m	33 61 431 0010 006
a = 2 m	33 61 431 0020 006
a = 3 m	33 61 431 0030 006
a = 4 m	33 61 431 0040 006
a = 5 m	33 61 431 0050 006
a = 6 m	33 61 431 0060 006
a = 7 m	33 61 431 0070 006
a = 8 m	33 61 431 0080 006
a = 9 m	33 61 431 0090 006
a = 10 m	33 61 431 0100 006
a = 11 m	33 61 431 0110 006
a = 12 m	33 61 431 0120 006
a = 13 m	33 61 431 0130 006
a = 14 m	33 61 431 0140 006
a = 15 m	33 61 431 0150 006
a = 20 m	33 61 431 0200 006
a = 25 m	33 61 431 0250 006
a = 30 m	33 61 431 0300 006
a = 35 m	33 61 431 0350 006
a = 40 m	33 61 431 0400 006
a = 45 m	33 61 431 0450 006
a = 50 m	33 61 431 0500 006
a = 60 m	33 61 431 0600 006
a = 70 m	33 61 431 0700 006
a = 80 m	33 61 431 0800 006
a = 90 m	33 61 431 0900 006
a = 100 m	33 61 431 1000 006

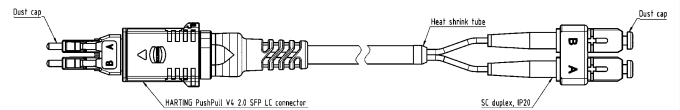

a = length

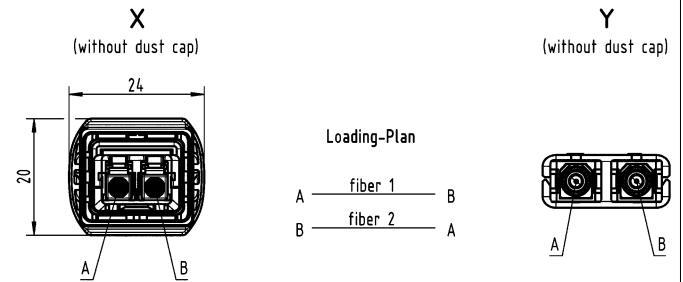

Fibre optic breakout cable,
multi mode, 62.5 / 125 µm

Length: 10 m	33 58 751 0100 001
Length: 20 m	33 58 751 0200 001
Length: 100 m	33 58 751 1000 001

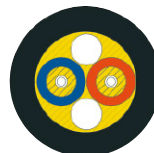

PUR jacket
2-fibre multi mode 62.5 µm
Outer diameter: 7 mm
Min. bending radius:
Installation: 10.5 cm
Operating: 7.0 cm



Features

- Connector types 2 x Han® 3 A,
 2 x LC duplex
- Type of core Single and multi mode
- Sheath material PVC, FRNC

Advantages

- Transmission of up to 10 Gbit/s
- Extremely robust
- Secured locking by Han® 3 A housing
- Suitable for outdoor application

Applications

- Industrial cabling
- Outdoor installation
- Antenna cabling
- Mining industry



Identification	Part number	Drawing	Dimensions in mm
<p>Fibre optic cable, double ended, single mode, metal 2 x Han® 3 A, 2 x LC duplex</p> <p>Length: a = 1 m</p> <p>a = 5 m</p> <p>a = 10 m</p> <p>a = 20 m</p> <p>a = 40 m</p> <p>a = 50 m</p> <p>a = 100 m</p>	<p>33 54 211 0010 001</p> <p>33 54 211 0050 001</p> <p>33 54 211 0100 001</p> <p>33 54 211 0200 001</p> <p>33 54 211 0400 001</p> <p>33 54 211 0500 001</p> <p>33 54 211 1000 001</p>	<p>double ended</p> <p>Protection level: IP65/IP67</p>	
<p>Fibre optic breakout cable, single mode</p> <p>Length: 10 m</p> <p>Length: 20 m</p> <p>Length: 100 m</p>	<p>33 54 751 0100 001</p> <p>33 54 751 0200 001</p> <p>33 54 751 1000 001</p>	<p>PVC jacket</p> <p>4-fibre single mode</p> <p>Outer diameter: 9.5 mm</p> <p>Min. bending radius:</p> <p>Installation: 15 x OD</p> <p>Operating: 10 x OD</p>	

Other cable lengths on request



Identification

Part number

Drawing

Dimensions in mm

Fibre optic cable, double ended, multi mode, metal, 50 µm
2 x Han® 3 A, 2 x LC duplex

- Length: a = 1 m
- a = 5 m
- a = 10 m
- a = 20 m
- a = 40 m
- a = 50 m
- a = 100 m

- 33 54 211 0010 002
- 33 54 211 0050 002
- 33 54 211 0100 002
- 33 54 211 0200 002
- 33 54 211 0400 002
- 33 54 211 0500 002
- 33 54 211 1000 002

double ended

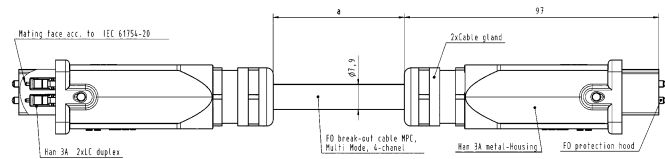

a = length

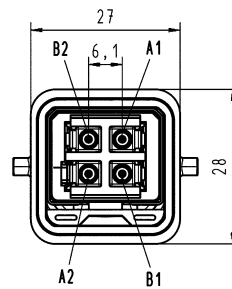

Protection level: IP65/IP67

Fibre optic breakout cable, multi mode, 50 µm

- Length: 10 m
- Length: 20 m
- Length: 100 m

- 33 54 751 0100 002
- 33 54 751 0200 002
- 33 54 751 1000 002

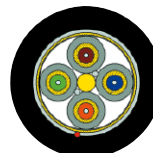

FRNC jacket
4-fibre multi mode 50 µm
Outer diameter: 7.9 mm
Min. bending radius:
Installation: 9.8 cm
Operating: 7.9 cm



Features

- | | |
|-------------------|-----------------------------|
| • Connector types | Han® 3 A, LC duplex, Hybrid |
| • Type of core | Single and multi mode |
| • Number of cores | 2 + 3 x power |
| • Wiring | Crossed (power 1:1) |
| • Sheath material | PVC |

Advantages

- Transmission of up to 10 Gbit/s
- Extremely robust
- Secured locking by Han® 3 A housing
- Suitable for outdoor application

Applications

- Industrial cabling
- Outdoor installation
- Antenna cabling
- Mining industry



Identification	Part number	Drawing	Dimensions in mm
<p>Hybrid fibre optic cable, single mode, double ended 2 x FO + 3 x 2.5 mm², 2 x Han® 3 A</p> <p>Length: a = 1 m AC version DC version</p> <p>a = 5 m AC version DC version</p> <p>a = 10 m AC version DC version</p> <p>a = 20 m AC version DC version</p> <p>a = 40 m AC version DC version</p> <p>a = 50 m AC version DC version</p> <p>a = 100 m AC version DC version</p>	<p>33 57 211 0015 003</p> <p>33 57 211 0015 004</p> <p>33 57 211 0055 003</p> <p>33 57 211 0055 004</p> <p>33 57 211 0105 003</p> <p>33 57 211 0105 004</p> <p>33 57 211 0205 003</p> <p>33 57 211 0205 004</p> <p>33 57 211 0405 003</p> <p>33 57 211 0405 004</p> <p>33 57 211 0505 003</p> <p>33 57 211 0505 004</p> <p>33 57 211 1005 003</p> <p>33 57 211 1005 004</p>	<p>double ended</p> <p>a = length</p> <p>Protection level: IP65/IP67</p>	
<p>Hybrid fibre optic cable, single mode, single ended 2 x FO + 3 x 2.5 mm², 1 x Han® 3 A</p> <p>Length: a = 1 m AC version DC version</p> <p>a = 5 m AC version DC version</p> <p>a = 10 m AC version DC version</p> <p>a = 20 m AC version DC version</p> <p>a = 40 m AC version DC version</p> <p>a = 50 m AC version DC version</p> <p>a = 100 m AC version DC version</p>	<p>33 57 111 0015 003</p> <p>33 57 111 0015 004</p> <p>33 57 111 0055 003</p> <p>33 57 111 0055 004</p> <p>33 57 111 0105 003</p> <p>33 57 111 0105 004</p> <p>33 57 111 0205 003</p> <p>33 57 111 0205 004</p> <p>33 57 111 0405 003</p> <p>33 57 111 0405 004</p> <p>33 57 111 0505 003</p> <p>33 57 111 0505 004</p> <p>33 57 111 1005 003</p> <p>33 57 111 1005 004</p>	<p>single ended</p> <p>a = length</p>	
<p>Hybrid fibre optic cable, single mode</p> <p>Length: 10 m</p> <p>Length: 20 m</p> <p>Length: 500 m</p>	<p>33 57 851 0100 004</p> <p>33 57 851 0200 004</p> <p>33 57 851 5000 004</p>	<p>PVC jacket</p> <p>2 x 9/125 + 3 x 2.5 mm²</p> <p>Outer diameter: 12.6 mm</p> <p>Min. bending radius:</p> <p>single: 5 x OD</p> <p>repeated: 10 x OD</p>	

Other cable lengths on request



Identification	Part number	Drawing	Dimensions in mm
----------------	-------------	---------	------------------

Hybrid fibre optic cable, multi mode, double ended
 2 x G50/125 + 3 x 2.5 mm²

Length: a = 1 m AC version
 DC version

a = 5 m AC version
 DC version

a = 10 m AC version
 DC version

a = 20 m AC version
 DC version

a = 40 m AC version
 DC version

a = 50 m AC version
 DC version

a = 100 m AC version
 DC version

33 57 211 0015 001
 33 57 211 0015 002

33 57 211 0055 001
 33 57 211 0055 002

33 57 211 0105 001
 33 57 211 0105 002

33 57 211 0205 001
 33 57 211 0205 002

33 57 211 0405 001
 33 57 211 0405 002

33 57 211 0505 001
 33 57 211 0505 002

33 57 211 1005 001
 33 57 211 1005 002

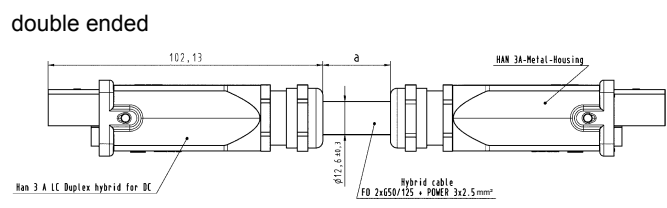

a = length

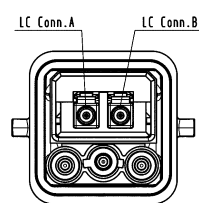

Protection level: IP65/IP67

Hybrid fibre optic cable, multi mode, single ended
 2 x G50/125 + 3 x 2.5 mm²

Length: a = 1 m AC version
 DC version

a = 5 m AC version
 DC version

a = 10 m AC version
 DC version

a = 20 m AC version
 DC version

a = 40 m AC version
 DC version

a = 50 m AC version
 DC version

a = 100 m AC version
 DC version

33 57 111 0015 001
 33 57 111 0015 002

33 57 111 0055 001
 33 57 111 0055 002

33 57 111 0105 001
 33 57 111 0105 002

33 57 111 0205 001
 33 57 111 0205 002

33 57 111 0405 001
 33 57 111 0405 002

33 57 111 0505 001
 33 57 111 0505 002

33 57 111 1005 001
 33 57 111 1005 002

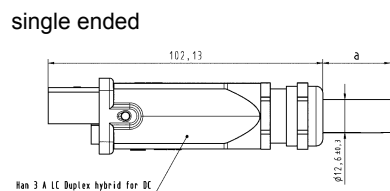

a = length

Hybrid fibre optic cable, multi mode, 50 µm

Length: 10 m

Length: 20 m

Length: 500 m

33 57 851 0100 002

33 57 851 0200 002

33 57 851 5000 002

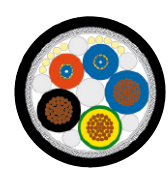

PVC jacket

2 x G50/125 + 3 x 2.5 mm²

Outer diameter: 12.6 mm

Min. bending radius:

single: 5 x OD

repeated: 10 x OD



System cable fibre optics

Features

- Connector types SCRJ
- Type of core POF, 980/1000 µm
- Number of cores 2
- Wiring Crossed
- Sheath material PUR

Advantages

- Transmission of up to 100 Mbit/s
- Flexible, space saving
- Simple connection to switches and SPS/controller
- PROFINET compliant

Applications

- Industrial cabling
- Industrial automation
- Switchboard cabling



System cable fibre optics

Identification	Part number	Drawing	Dimensions in mm
<p>SCRJ double ended Hood: plastic hood with top entry Cable: POF, multi mode, 980/1000 μm, PROFINET type C</p>			
<p>Length: a = 1 m</p>	33 02 211 0010 001		
<p>a = 2 m</p>	33 02 211 0020 001		
<p>a = 5 m</p>	33 02 211 0050 001		
<p>a = 10 m</p>	33 02 211 0100 001		
<p>a = 20 m</p>	33 02 211 0200 001		

Other cable lengths on request

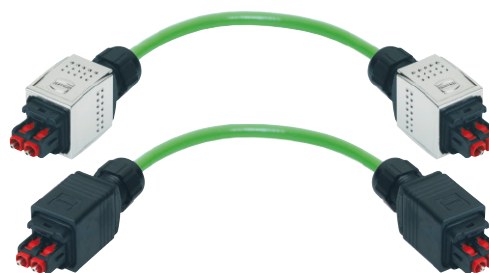

Features

- Connector types PushPull V14, SCRJ
- Type of core POF, 980/1000 μm
- Number of cores 2
- Wiring Crossed
- Sheath material PUR

Advantages

- Transmission of up to 100 Mbit/s
- Flexible, space saving
- Simple handling by HAN® PushPull
- PROFINET compliant

Applications

- Industrial cabling
- Industrial automation
- Outdoor installation



Identification	Part number	Drawing	Dimensions in mm
----------------	-------------	---------	------------------

Han® PushPull SCRJ
 double ended
 Hood: plastic with top entry
 Cable: POF, multi mode,
 980/1000 μm,
 PROFINET type C

Length: a = 1 m
 a = 2 m
 a = 5 m
 a = 10 m
 a = 20 m

33 53 211 0010 001
 33 53 211 0020 001
 33 53 211 0050 001
 33 53 211 0100 001
 33 53 211 0200 001

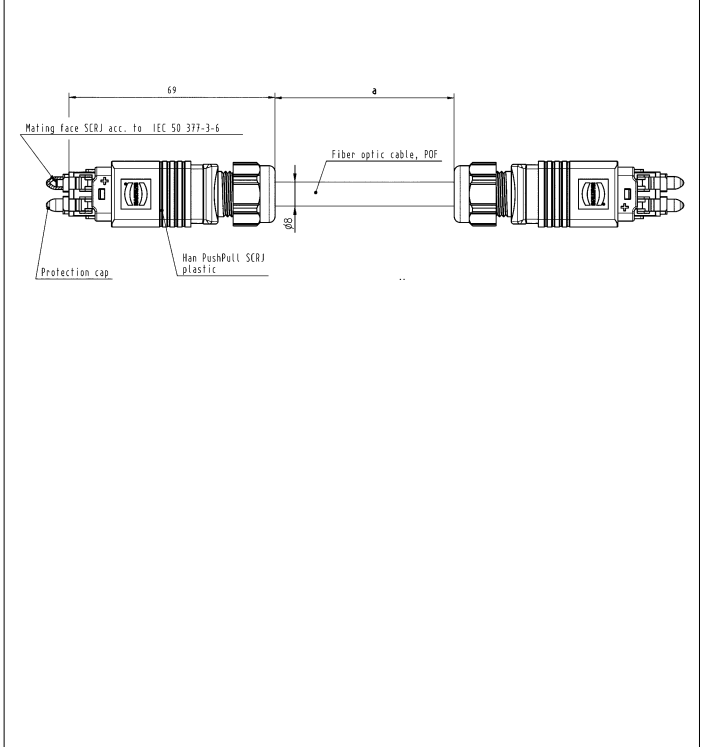

Han® PushPull SCRJ
 double ended
 Hood: metal with top entry
 Cable: POF, multi mode,
 980/1000 μm,
 PROFINET type C

Length: a = 1 m
 a = 2 m
 a = 5 m
 a = 10 m
 a = 20 m

33 53 211 0010 002
 33 53 211 0020 002
 33 53 211 0050 002
 33 53 211 0100 002
 33 53 211 0200 002

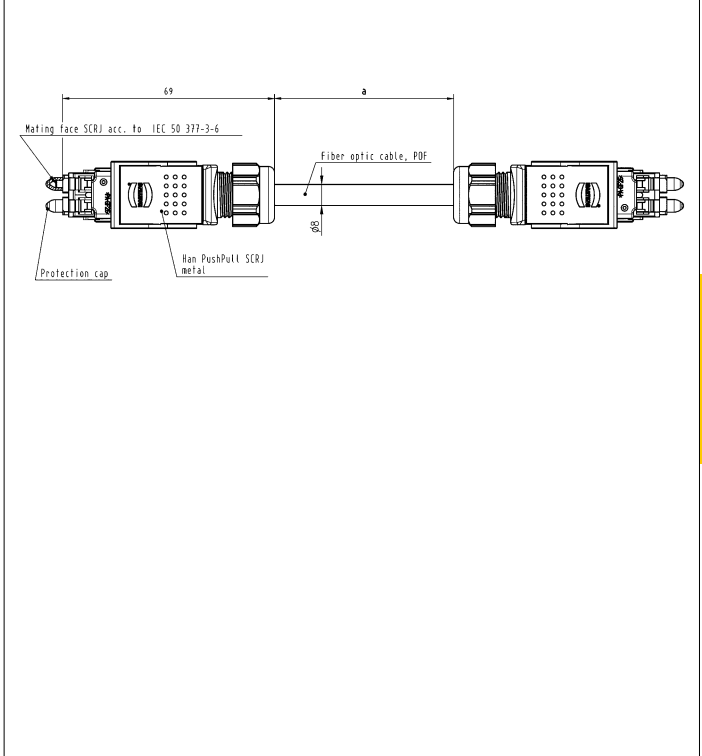



Han® PushPull, type acc. to IEC 61 076-3-117 variant 14
 RJ45 panel feed through
 for optical connector based on SCRJ

Features

- HARTING PushPull technology
- Compact design
- High packing density
- Han® PushPull SCRJ for POF is according the requirements of AIDA (German Domestic Automobile Manufacturers)

Technical characteristics

Locking	PushPull technology
Degree of protection	IP65 / IP67
Mating face	SCRJ acc. to IEC 61 754-24
Fiber Typen	POF ¹⁾ 1 mm HCS ²⁾ 200 µm / 230 µm MM 62.5 µm / 125 µm MM 50 µm / 125 µm SM 10 µm / 125 µm
Mating cycles	min. 750
Temperature range	-40 °C ... +70 °C
Housing material	Plastic, black
Flammability acc. to UL 94	V0

Identification

Part number

Drawing

Dimensions in mm

Han® PushPull SCRJ

Panel feed through

09 35 242 0333

SC contacts order separately

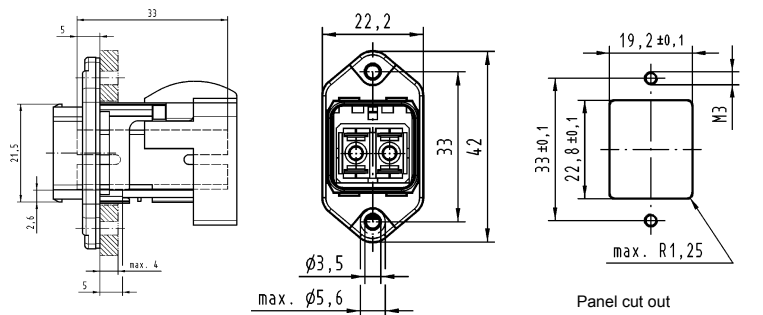

SCRJ IP20

POF connector

with fast termination

09 35 002 4002

with crimp termination

09 35 002 4003

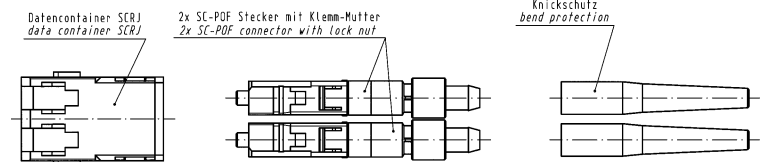

Contacts

SC POF contact, 1 mm

20 10 001 5217

SC 125 GI contact

20 10 125 5211

SC 230 HCS contact

20 10 230 5211

¹⁾ POF = Polymer-Optical Fibre

²⁾ HCS® = Hard Clad Silica (registered trademark of SpecTran Corporation)



Han® PushPull, type acc. to IEC 61 076-3-117 variant 14
SCRJ connector

Features

- HARTING PushPull technology
- Compact design
- High packing density
- Han® PushPull SCRJ for POF is according the requirements of AIDA (German Domestic Automobile Manufacturers)
- Field installable

Technical characteristics

Locking	PushPull technology
Degree of protection	IP65 / IP67
Mating face	SCRJ acc. to IEC 61 754-24
Fiber Typen	POF ¹⁾ 1 mm HCS ^{®2)} 200 µm / 230 µm MM 62.5 µm / 125 µm MM 50 µm / 125 µm SM 10 µm / 125 µm
Mating cycles	min. 750
Temperature range	-40 °C ... +70 °C
Housing material	Plastic, black
Flammability acc. to UL 94	V0
Cable diameter	6.5 - 9.5 mm

Identification	Part number	Drawing	Dimensions in mm
----------------	-------------	---------	------------------

Connector set, plastic

incl. housing and SCRJ insert,
POF contacts

PROFINET-Identification:
PROFINET O-Plug SCRJ

incl. housing and SCRJ insert
SC contacts order separately

09 35 241 0421

09 35 241 0422

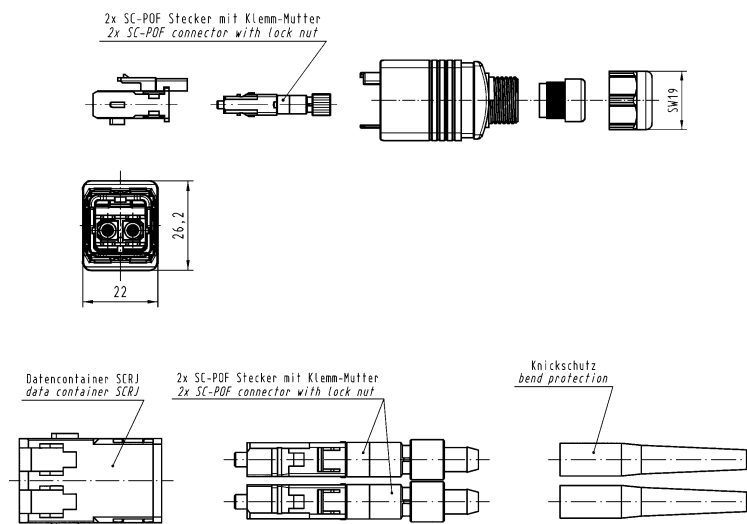

SCRJ IP20 POF connector

09 35 002 4002

Protection cover IP65 / IP67

09 35 002 5411

Contacts

SC POF contact, 1 mm
SC 125 GI contact
SC 230 HCS contact

20 10 001 5217
20 10 125 5211
20 10 230 5211



Han® PushPull, type acc. to IEC 61 076-3-117 variant 14
 RJ45 panel feed through
 for optical connector based on SCRJ

Features

- HARTING PushPull technology
- Compact design
- High packing density
- Han® PushPull SCRJ for POF is according the requirements of AIDA (German Domestic Automobile Manufacturers)

Technical characteristics

Locking	PushPull technology
Degree of protection	IP65 / IP67
Mating face	SCRJ acc. to IEC 61 754-24
Fiber Typen	POF ¹⁾ 1 mm HCS ²⁾ 200 µm / 230 µm MM 62.5 µm / 125 µm MM 50 µm / 125 µm SM 10 µm / 125 µm
Mating cycles	min. 750
Temperature range	-40 °C ... +70 °C
Housing material	Zinc die-cast, nickel plated

Identification	Part number	Drawing	Dimensions in mm
----------------	-------------	---------	------------------

Han® PushPull SCRJ

Panel feed through

09 35 242 0313

SC contacts order separately

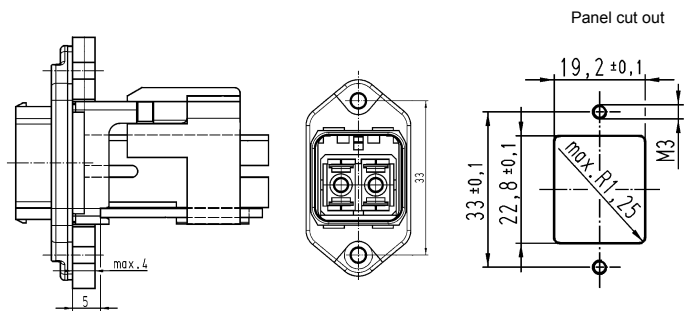

SCRJ IP20

POF connector

with fast termination

09 35 002 4002

with crimp termination

09 35 002 4003

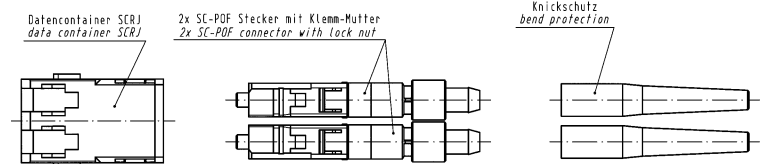

Contacts

SC POF contact, 1 mm

20 10 001 5217

SC 125 GI contact

20 10 125 5211

SC 230 HCS contact

20 10 230 5211

¹⁾ POF = Polymer-Optical Fibre

²⁾ HCS® = Hard Clad Silica (registered trademark of SpecTran Corporation)



Han® PushPull, type acc. to IEC 61 076-3-117 variant 14
SCRJ connector with fast termination

Features

- HARTING PushPull technology
- Compact design
- High packing density
- Han® PushPull SCRJ for POF is according the requirements of AIDA (German Domestic Automobile Manufacturers)
- Field installable

Technical characteristics

Locking	PushPull technology
Degree of protection	IP65 / IP67
Mating face	SCRJ acc. to IEC 61 754-24
Fiber Typen	POF ¹⁾ 1 mm HCS ²⁾ 200 µm / 230 µm MM 62.5 µm / 125 µm MM 50 µm / 125 µm SM 10 µm / 125 µm
Mating cycles	min. 750
Temperature range	-40 °C ... +70 °C
Housing material	Zinc die-cast, nickel plated
Flammability acc. to UL 94	V0
Cable diameter	6.5 - 9.5 mm

Identification	Part number	Drawing	Dimensions in mm
----------------	-------------	---------	------------------

Connector set, metal
incl. housing and SCRJ insert,
POF contacts

09 35 241 0401

PROFINET-Identification:
PROFINET O-Plug SCRJ

incl. housing and SCRJ insert
SC contacts order separately

09 35 241 0402

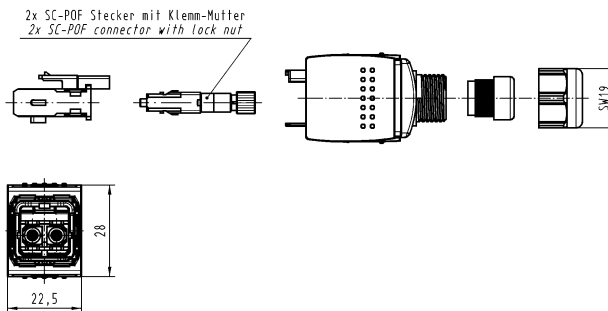

SCRJ IP20
POF connector

09 35 002 4002

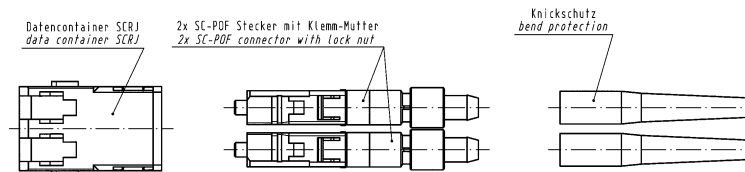

Protection cover IP65 / IP67

09 35 002 5411

Contacts

- SC POF contact, 1 mm
- SC 125 GI contact
- SC 230 HCS contact

20 10 001 5217
20 10 125 5211
20 10 230 5211

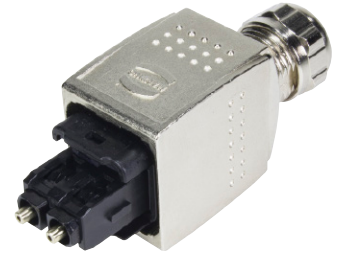

Han® PushPull, type acc. to IEC 61 076-3-117 variant 14
SCRJ crimp connector

Features

- HARTING PushPull technology
- Compact design
- High packing density
- Han® PushPull SCRJ for POF is according the requirements of AIDA (German Domestic Automobile Manufacturers)

Technical characteristics

Locking	PushPull technology
Degree of protection	IP65 / IP67
Mating face	SCRJ acc. to IEC 61 754-24
Fiber Typen	POF ¹⁾ 980 µm / 1000 µm
Mating cycles	min. 750
Temperature range	-40 °C ... +70 °C
Housing material	Zinc die-cast, nickel plated
Flammability acc. to UL 94	V0
Cable diameter	6.5 - 9.5 mm

Identification

Part number

Drawing

Dimensions in mm

Connector set, metal

incl. housing and SCRJ insert,
POF crimp contacts

09 35 242 0401

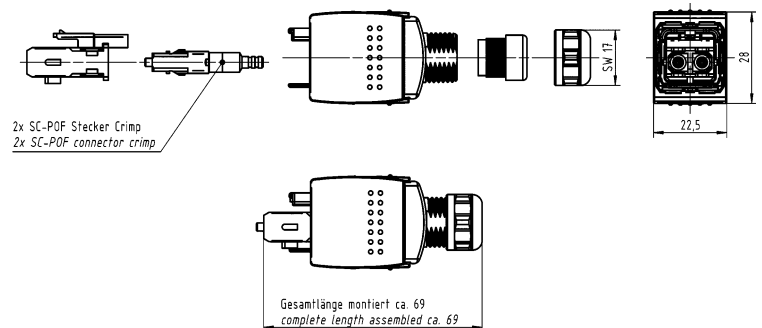

SCRJ IP20

POF crimp connector

09 35 002 4003

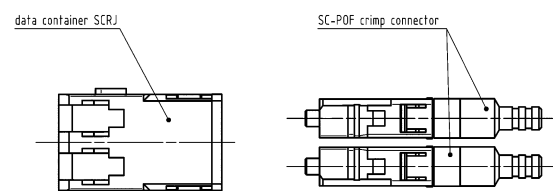

Protection cover

IP65 / IP67

09 35 002 5411

Contacts

SC POF crimp contact

20 10 001 5211

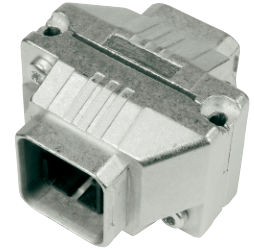

Han® PushPull SCRJ Genderchanger Metal

Features

- High degree of protection IP65 / IP67
- Robust metal housing
- Standard PROFINET component of the German automotive production
- Allows usage of different cable types (Type B, C) e.g. in robots application
- Extension of cords according to PROFINET guideline

Technical characteristics

Locking	PushPull technology
Degree of protection	IP65 / IP67 (mated)
Mating face	SCRJ acc. to IEC 61 754-24
Fibre types	POF, GOF, HCS
Number of contacts	2
Mating cycles	min. 750
Temperature range	-40 °C ... +70 °C
Housing material	Zinc die-cast, nickel-plated
Dimensions	43.3 x 42 x 29 mm (unmated)
Mounting	Wall mountable with 2 screws (type M3)

Identification

Part number

Drawing

Dimensions in mm

Han® PushPull SCRJ
Genderchanger metal

09 35 241 0501

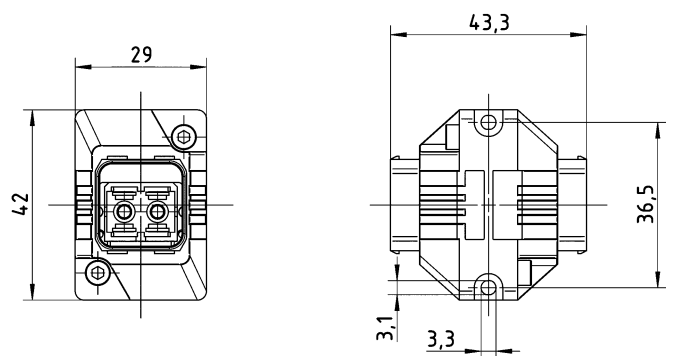



Han® PushPull SCRJ POF crimp Assembly tools for polymer-optical fibres

Features

- Cable insulation (PUR / PVC) is stripped without damage
- The 'crimping' and 'precision cutting' operations are completed within the one tool
- Specialized cutting method with an automatically advancing round blade for an accurate cutting result requiring no final polishing
- Optical display indicating remaining operations
- Simultaneous crimping of two contacts (duplex handling)

Technical characteristics

Connector type	SCRJ crimp connector acc. to IEC 61 754-24
Locking	PushPull technology acc. to IEC 61 076-3-117 variant 14 (AIDA compliant)
Insertion loss	typically 1.5 to 2.0 dB
Termination SC contacts	Crimp termination technique
Fibre dimensions	POF 980 / 1000 µm
Fibre outer diameter	2.2 mm
Cable outer diameter	7 to 8.5 mm
No. of cutting operations	Maximum 2500

Identification	Part number	Drawing	Dimensions in mm
----------------	-------------	---------	------------------

Assembly tool set
for POF crimp cutting,
without final polishing

09 35 000 9915

- The set contains
- one crimping and cutting tool for 2500 operations
 - one sheath stripping tool
 - one Kevlar shear
 - one loading device for SC contacts
- Supplied in a robust plastic case

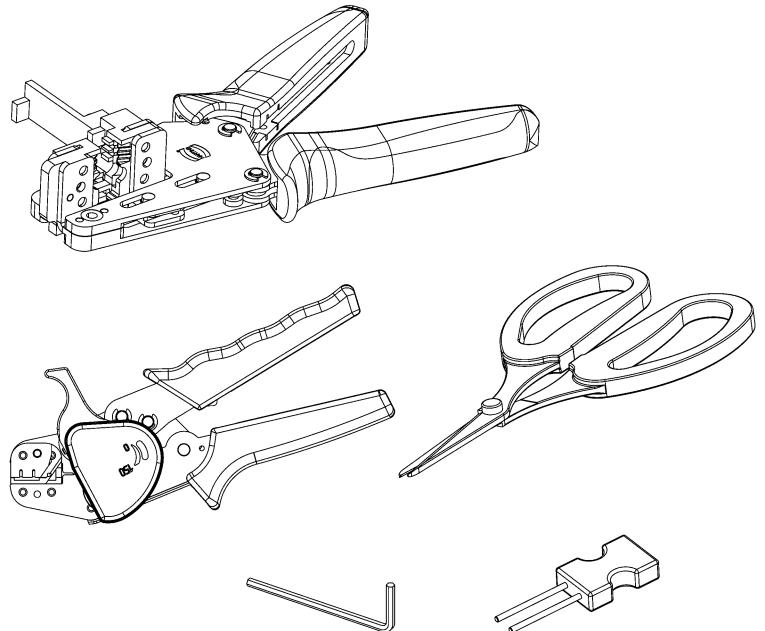

Replacement cutting tool

09 35 000 9914



Han® PushPull SCRJ POF Assembly tools for polymer-optical fibres

Features

- Cable insulation (PUR / PVC) is stripped without damage
- The 'stripping' and 'precision cutting' operations are completed within the one tool
- Specialized cutting method with an automatically advancing round blade for an accurate cutting result requiring no final polishing
- Optical display indicating remaining operations
- Simultaneous handling of twin fibers (duplex mode)

Technical characteristics

Connector type	SCRJ connector acc. to IEC 61754-24
Locking	PushPull technology acc. to IEC 61076-3-117 variant 14 (AIDA compliant)
Insertion loss	typically 1.5 to 2.0 dB
Termination SC contacts	Fast termination technique, reusable
Fibre dimensions	POF 980 / 1000 µm
Fibre outer diameter	2.2 mm
Cable outer diameter	7 to 8.5 mm
No. of cutting operations	Maximum 2500

Identification	Part number	Drawing	Dimensions in mm
Assembly tool set for POF cutting, without final polishing The set contains - one stripping and cutting tool for 2500 operations - one sheath stripping tool - one Kevlar shear - one positioner for SCRJ contacts Supplied in a robust plastic case	09 35 000 9913		
Replacement cutting tool for 2500 operations	09 35 000 9914		
Assembly tool set for POF cutting, with final polishing Without an optical meter With an optical meter	20 99 000 3016 20 99 000 3013		
Polishing wheel (grinding wheel) for POF cables 2.2	20 99 000 1099		
Sand paper for POF, grain size 1000	20 80 001 9911		

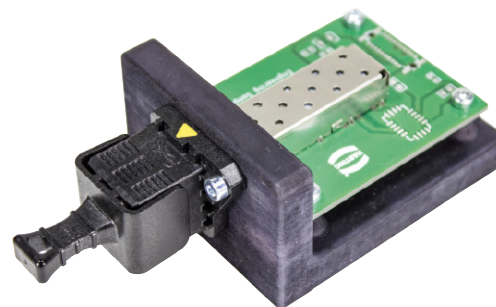

PushPull XS SFP
Device integration and system cable

Advantages

- Optical PushPull connector based on LC with small form factor (requires 50 % compared to SC and ST)
- Shortest, most compact cable solution equipped with SFP transceiver directly pluggable into the device (length of mated pair appr. 60 mm)
- Small installation pitch: 30 mm
- Multiple transceivers for LC and RJ45 can be used in the same port
- Blind mating capability

Technical characteristics

Locking	PushPull Technology
Degree of protection	IP65/IP67
Mating face	LC acc. to IEC 61754-20
Mating cycles	Min. 50
Temperature range	-40 °C ... +85 °C
Housing material	Plastic, black
Flammability acc. to UL 94	V0
XXX = length	001 = 1 m, 002 = 2 m ... 010 = 10 m, 100 = 100 m
Available length	1 up to 15 m: in 1 m steps
	20, 25, 30, 35, 40, 45, 50, 60, 70, 80, 90, 100 m

Identification

Part number

Drawing

Dimensions in mm

Housing bulkhead mounting, short

09 57 411 0501 200¹⁾

Housing bulkhead mounting, long

09 57 411 0501 201²⁾

Protection cover device side

09 57 411 0501 202

SFP cage

solder termination
press in termination

33 11 000 0180 000
33 11 000 0179 000

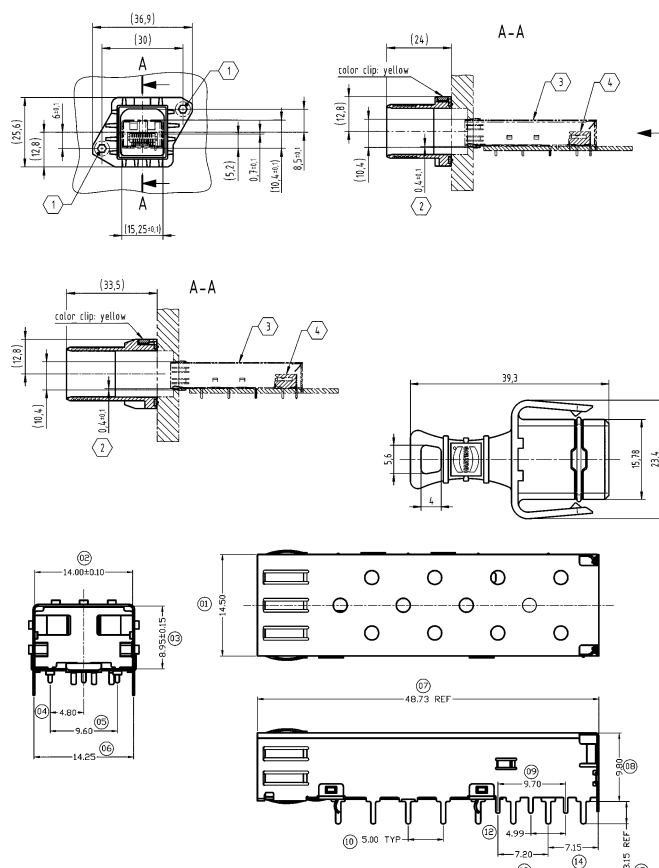

1) Only for LC transceiver
2) For LC and RJ45 transceiver

PushPull XS SFP Device integration and system cable



Identification	Part number	Drawing	Dimensions in mm
----------------	-------------	---------	------------------

Fibre optic cable
PUR jacket,
multi mode, 50 µm,
overmoulded
2 x PushPull XS

33 26 231 xxx0 012¹⁾

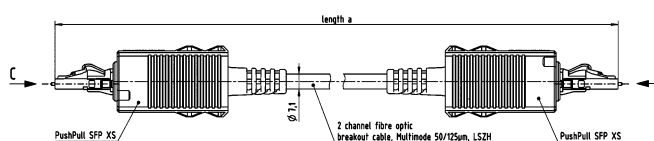

Fibre optic cable
PUR jacket,
multi mode, 50 µm,
overmoulded
2 x PushPull XS

33 26 231 xxx0 014²⁾

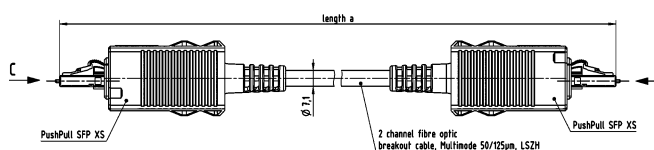

Fibre optic cable
PUR jacket,
multi mode, 50 µm,
overmoulded
1 x PushPull XS
1 x LC duplex

33 26 231 xxx0 013¹⁾

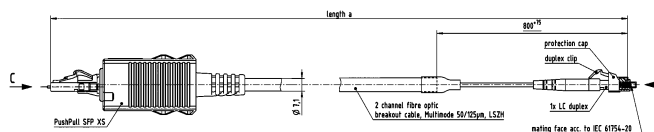

Fibre optic cable
PUR jacket,
multi mode, 50 µm,
overmoulded
1 x PushPull XS
1 x LC duplex

33 26 231 xxx0 018²⁾

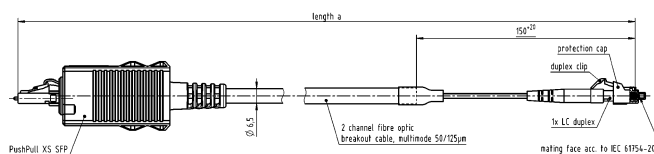

1) For housing 09 57 411 0501 201
2) For housing 09 57 411 0501 200

PushPull XS SFP
Device integration
and system cable



Identification	Part number	Drawing	Dimensions in mm
<p>Fibre optic cable</p> <p>PUR jacket, single mode, 9/125 µm, overmoulded</p> <p>2 x PushPull XS</p>	33 26 231 xxx0 011 ¹⁾		
<p>Fibre optic cable</p> <p>PUR jacket, single mode, 9/125 µm, overmoulded</p> <p>2 x PushPull XS</p>	33 26 231 xxx0 015 ²⁾		
<p>Fibre optic cable</p> <p>PUR jacket, single mode, 9/125 µm, overmoulded</p> <p>1 x PushPull XS 1 x LC duplex</p>	33 26 231 xxx0 016 ¹⁾		
<p>Fibre optic cable</p> <p>PUR jacket, single mode, 9/125 µm, overmoulded</p> <p>1 x PushPull XS 1 x LC duplex</p>	33 26 231 xxx0 017 ²⁾		

1) For housing 09 57 411 0501 201
2) For housing 09 57 411 0501 200



PushPull XS SFP
Device integration and system cables

Identification	Part number	Drawing	Dimensions in mm
----------------	-------------	---------	------------------

Cat. 6_A cable
PVC jacket,
overmoulded
1 x PushPull XS
1 x RJ45

33 25 231 xxx0 001

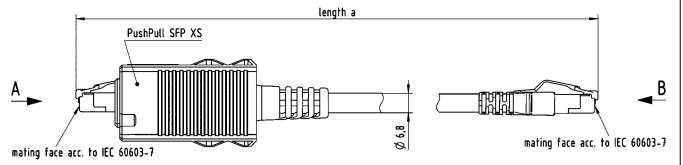



System cables and panel feed-throughs

Advantages

- IP68 rated, mated and unmated
- Hermaphroditic design: no male, no female. Always the correct mating face where needed
- Easy link extension by connecting multiple, identical cable assemblies
- No mismatching
- Extremely robust

Technical characteristics

Degree of protection	IP68, mated and unmated
Temperature range	-40 °C ... +85 °C
Housing material	Aluminium
Housing properties	Shock protected by rubber grip ring, dust cap and boot
Housing colour	RAL 1021 for better identification and differentiation from other cables
Available lengths	10 m, 25 m, 50 m, 100 m, 150 m, 200 m, 250 m, 500 m Other cable lengths on request
Fibres	2 and 4, multi and single mode

Identification	Part number	Drawing	Dimensions in mm
----------------	-------------	---------	------------------

Plug to plug cable assembly

2 channel

multi mode
single mode

33 04 211 xxx0 001
33 04 211 xxx0 003

4 channel

multi mode
single mode

33 04 211 xxx0 002
33 04 211 xxx0 004

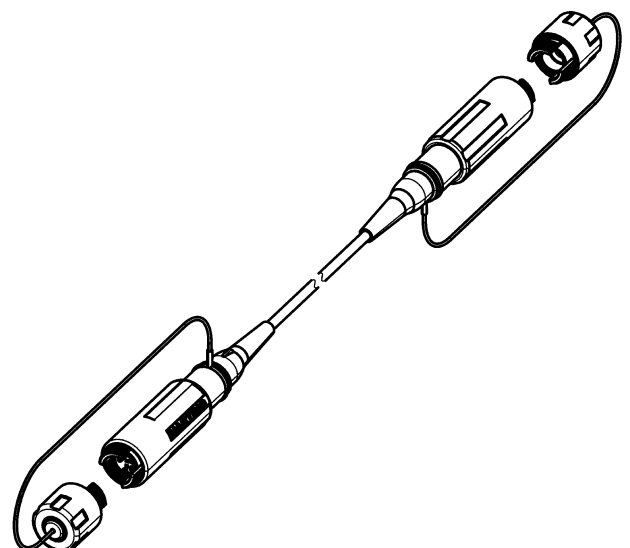



System cables and panel feed-throughs

Identification	Part number	Drawing	Dimensions in mm
Bulkhead cable assembly, 1 m			
2 channel to 2 x LC multi mode single mode	33 04 411 0010 001 33 04 411 0010 005		
4 channel to 4 x LC multi mode single mode	33 04 411 0010 003 33 04 411 0010 006		
2 channel to 2 x SC multi mode single mode	33 04 411 0010 002 33 04 411 0010 007		
4 channel to 4 x SC multi mode single mode	33 04 411 0010 004 33 04 411 0010 008		

List of part numbers



Part number	Page	Part number	Page	Part number	Page	Part number	Page
09 14 000 9915	05.19	09 20 003 0327	03.82	09 37 003 0301	03.82	09 45 195 1100	03.64
09 14 000 9915	05.31	09 20 003 5422	03.88	09 37 003 0306	03.82	09 45 195 1520	03.64
09 14 001 3011	05.21	09 20 003 5425	03.78	09 37 003 5402	03.88	09 45 195 1560	03.65
09 14 001 3011	05.33	09 20 003 5425	03.92	09 37 003 5405	03.78	09 45 200 1560	03.79
09 14 001 3111	05.21	09 20 003 5442	03.88	09 37 003 5405	03.92	09 45 200 1560	03.81
09 14 001 3111	05.33	09 20 003 5449	03.78			09 45 200 1560	04.06
09 14 001 4623	03.102	09 20 003 5449	03.92			09 45 200 1760	03.93
09 14 001 4721	03.99			09 45 100 1100	03.76	09 45 215 1107	03.78
09 14 001 4722	03.101			09 45 100 1100	04.05	09 45 215 1108	03.78
09 14 002 3001	05.19	09 35 000 9913	06.42	09 45 100 1110	03.76	09 45 215 1109	03.78
09 14 002 3001	05.31	09 35 000 9914	06.41	09 45 100 1110	04.05	09 45 215 1110	03.78
09 14 002 3101	05.19	09 35 000 9914	06.42	09 45 100 1520	03.74	09 45 215 1560	03.79
09 14 002 3101	05.31	09 35 000 9915	06.41	09 45 100 1520	03.76	09 45 215 1561	03.79
09 14 008 3011	05.33	09 35 002 0431	03.59	09 45 100 1520	04.05	09 45 215 1562	03.79
09 14 008 3016	05.21	09 35 002 0433	03.59	09 45 100 1560	03.73	09 45 215 1760	03.92
09 14 008 3017	05.21	09 35 002 4002	06.35	09 45 100 1560	03.76	09 45 215 1761	03.92
09 14 008 3111	05.33	09 35 002 4002	06.36	09 45 100 1560	04.05	09 45 215 1762	03.92
09 14 008 3116	05.21	09 35 002 4002	06.37	09 45 100 1720	03.88	09 45 215 1765	03.92
09 14 008 3117	05.21	09 35 002 4002	06.38	09 45 100 1720	03.89		
09 14 008 4720	03.101	09 35 002 4003	06.35	09 45 100 1760	03.88	09 45 225 1107	03.78
09 14 545 1120	03.101	09 35 002 4003	06.37	09 45 100 1760	03.89	09 45 225 1108	03.78
09 14 545 1561	03.101	09 35 002 4003	06.39	09 45 115 1100	03.72	09 45 225 1560	03.79
09 14 545 1562	03.101	09 35 002 4003	06.39	09 45 115 1102	03.72	09 45 225 1760	03.92
		09 35 002 5402	03.63	09 45 115 1104	03.72	09 45 225 1761	03.93
		09 35 002 5402 XL	03.63	09 45 115 1106	03.72	09 45 245 1561	03.66
		09 35 002 5404	03.63	09 45 115 1520	03.74	09 45 245 1590	03.66
		09 35 002 5404 XL	03.63	09 45 115 1522	03.74	09 45 281 2560	03.47
09 15 000 6121	05.19	09 35 002 5411	03.63	09 45 115 1560	03.73	09 45 281 2560 333	03.47
09 15 000 6121	05.21	09 35 002 5411	06.36	09 45 115 1720	03.88	09 45 295 1130	03.66
09 15 000 6122	05.19	09 35 002 5411	06.38	09 45 115 1760	03.88		
09 15 000 6122	05.21	09 35 002 5411	06.39			09 45 345 0000	03.69
09 15 000 6123	05.19	09 35 002 5413	03.63	09 45 125 1100	03.72	09 45 345 0001	03.69
09 15 000 6123	05.21			09 45 125 1104	03.72	09 45 345 1560	03.67
09 15 000 6124	05.19	09 35 012 0311	03.58	09 45 125 1300	03.88		
09 15 000 6124	05.21	09 35 012 0312	03.58	09 45 125 1520	03.74	09 45 400 1100	03.103
09 15 000 6125	05.19	09 35 012 0331	03.58	09 45 125 1560	03.73	09 45 400 1109	03.103
09 15 000 6125	05.21			09 45 125 1720	03.88	09 45 400 1520	03.103
09 15 000 6126	05.19	09 35 221 0401	03.52	09 45 125 1760	03.88	09 45 400 1560	03.103
09 15 000 6126	05.21	09 35 221 0421	03.51				
09 15 000 6221	05.19	09 35 221 0501	03.60	09 45 145 1106	03.64	09 45 452 0000	03.105
09 15 000 6221	05.21			09 45 145 1521	03.64	09 45 452 0001	03.105
09 15 000 6222	05.19	09 35 222 0421	03.51	09 45 145 1521 XL	03.64	09 45 452 0002	03.105
09 15 000 6222	05.21			09 45 145 1561	03.65	09 45 452 1000	03.109
09 15 000 6223	05.19	09 35 225 0311	03.56			09 45 452 1001	03.109
09 15 000 6223	05.21	09 35 225 0312	03.56	09 45 151 0010	03.33	09 45 452 1010	03.109
09 15 000 6224	05.19	09 35 225 0331	03.56	09 45 151 0021	03.33	09 45 452 1500	03.104
09 15 000 6224	05.21	09 35 225 0401	03.52	09 45 151 0022	03.33	09 45 452 1501	03.104
09 15 000 6225	05.19	09 35 225 0402	03.53	09 45 151 0023	03.33	09 45 452 1502	03.104
09 15 000 6225	05.21	09 35 225 0403	03.53	09 45 151 0024	03.33	09 45 452 1504	03.104
09 15 000 6226	05.19	09 35 225 0421	03.51	09 45 151 0025	03.33	09 45 452 1506	03.104
09 15 000 6226	05.21			09 45 151 0026	03.33	09 45 452 1509	03.104
09 15 004 3013	05.19	09 35 226 0401	03.52	09 45 151 0026	03.33	09 45 452 1510	03.104
09 15 004 3113	05.19	09 35 226 0402	03.53	09 45 151 1100	03.28	09 45 452 1511	03.104
09 15 008 3013	05.31	09 35 226 0403	03.53	09 45 151 1108	03.28	09 45 452 1512	03.104
09 15 008 3113	05.31	09 35 226 0421	03.51	09 45 151 1109	03.28	09 45 452 1513	03.104
09 15 503 0301	04.07	09 35 227 0401	03.54	09 45 151 1120	03.29	09 45 452 1513	03.104
09 15 503 0901	04.07	09 35 227 0421	03.54	09 45 151 1121	03.29	09 45 452 1514	03.104
09 15 503 1701	04.07			09 45 151 1122	05.14	09 45 452 1515	03.104
09 15 503 5401	04.07	09 35 228 0421	03.51	09 45 151 1130	03.30	09 45 452 1516	03.104
09 15 503 5411	04.05			09 45 151 1520	03.32	09 45 452 1517	03.104
09 15 503 9911	04.05	09 35 241 0401	06.38	09 45 151 1520 XL	03.32	09 45 452 1518	03.104
09 15 503 9911	04.07	09 35 241 0402	06.38	09 45 151 1524	03.33	09 45 452 1530	03.104
		09 35 241 0421	06.36	09 45 151 1525	03.32	09 45 452 1531	03.104
		09 35 241 0422	06.36	09 45 151 1560	03.31	09 45 452 1532	03.104
		09 35 241 0501	06.40	09 45 151 1560 XL	03.31	09 45 452 1534	03.104
				09 45 151 1561	03.31	09 45 452 1536	03.104
09 20 003 0301	03.82	09 35 242 0313	06.37			09 45 452 1539	03.104
09 20 003 0306	03.82	09 35 242 0333	06.35	09 45 181 2560 XL	03.48	09 45 452 1540	03.104
09 20 003 0320	03.82	09 35 242 0401	06.39	09 45 181 2561 XL	03.48	09 45 452 1541	03.104

List of part numbers



Part number	Page	Part number	Page	Part number	Page	Part number	Page
09 45 452 1542	03.104	09 45 545 1120	03.81	09 45 600 0110	02.08	09 45 600 0694	05.23
09 45 452 1543	03.104	09 45 545 1120	03.86	09 45 600 0111	02.11	09 45 600 0711	02.22
09 45 452 1544	03.104	09 45 545 1120	03.93	09 45 600 0112	02.09	09 45 600 0721	02.22
09 45 452 1545	03.104	09 45 545 1120	03.106	09 45 600 0114	02.09	09 45 600 0751	02.22
09 45 452 1546	03.104	09 45 545 1120	04.06	09 45 600 0115	02.10	09 45 600 1110	02.12
09 45 452 1547	03.104	09 45 545 1122	03.39	09 45 600 0117	02.11	09 45 600 1120	02.12
09 45 452 1548	03.104	09 45 545 1500	01.32	09 45 600 0118	05.11	09 45 600 1130	02.12
09 45 452 1560	03.104	09 45 545 1500	03.59	09 45 600 0128	05.11	09 45 600 1140	02.12
09 45 452 1561	03.104	09 45 545 1500	03.69	09 45 600 0130	02.08	09 45 600 1200	02.13
09 45 452 1901	03.107	09 45 545 1500	03.81	09 45 600 0131	02.11	09 45 600 1210	02.13
09 45 452 1902	03.107	09 45 545 1500	03.93	09 45 600 0132	02.09	09 45 600 1211	02.14
09 45 452 1903	03.107	09 45 545 1500	04.06	09 45 600 0134	02.09	09 45 600 1220	02.13
09 45 452 1904	03.107	09 45 545 1501	01.32	09 45 600 0135	02.10	09 45 600 1221	02.14
09 45 452 1910	03.107	09 45 545 1502	01.32	09 45 600 0136	02.15	09 45 600 1230	02.13
09 45 452 1911	03.107	09 45 545 1503	01.32	09 45 600 0137	02.11	09 45 600 1231	02.14
09 45 452 1912	03.107	09 45 545 1504	01.32	09 45 600 0138	05.15	09 45 600 1241	02.14
09 45 452 1913	03.107	09 45 545 1505	01.32	09 45 600 0140	02.08	09 45 600 1400	05.11
09 45 452 1914	03.107	09 45 545 1506	01.32	09 45 600 0141	02.11	09 45 600 1410	05.11
09 45 452 1915	03.107	09 45 545 1507	01.32	09 45 600 0142	02.09	09 45 600 1420	05.11
09 45 452 1920	03.107	09 45 545 1508	01.32	09 45 600 0144	02.09	09 45 600 1430	05.11
09 45 452 1921	03.107	09 45 545 1509	01.32	09 45 600 0145	02.10	09 45 600 1440	05.11
09 45 452 1922	03.107	09 45 545 1510	01.32	09 45 600 0146	02.15	09 45 700 0023	01.19
09 45 452 1923	03.107	09 45 545 1511	01.32	09 45 600 0147	02.11	09 45 700 0025	01.19
09 45 452 1924	03.107	09 45 545 1512	01.32	09 45 600 0148	05.15	09 45 700 0027	01.19
09 45 452 1925	03.107	09 45 545 1513	01.32	09 45 600 0156	02.15	09 45 700 0051	01.19
09 45 452 1926	03.107	09 45 545 1514	01.32	09 45 600 0158	05.15	09 45 700 0053	01.19
09 45 452 1927	03.107	09 45 545 1515	01.32	09 45 600 0168	05.11	09 45 700 1164	01.19
09 45 452 1928	03.107	09 45 545 1516	01.32	09 45 600 0178	05.11	09 45 700 1166	01.19
09 45 452 1930	03.108	09 45 545 1517	01.32	09 45 600 0181	05.39	09 45 700 1168	01.19
09 45 452 1931	03.108	09 45 545 1518	01.32	09 45 600 0188	05.15	09 45 700 1173	01.19
09 45 452 1932	03.108	09 45 545 1518	03.59	09 45 600 0189	05.15	09 45 700 1175	01.19
09 45 452 1933	03.108	09 45 545 1518	03.69	09 45 600 0191	05.39	09 45 700 5022	01.48
09 45 452 1934	03.108	09 45 545 1518	03.81	09 45 600 0200	02.16	09 45 700 5025	01.48
09 45 452 1940	03.108	09 45 545 1518	03.93	09 45 600 0220	02.16	09 45 700 5027	01.48
09 45 452 1950	03.108	09 45 545 1518	04.06	09 45 600 0230	02.16	09 45 700 5051	01.48
09 45 452 1951	03.108	09 45 545 1560	03.35	09 45 600 0240	02.16	09 45 700 5053	01.48
09 45 452 1952	03.108	09 45 545 1561	03.36	09 45 600 0270	05.35	09 45 700 5063	01.48
09 45 452 1953	03.108	09 45 545 1561	03.59	09 45 600 0280	05.37	09 45 700 5066	01.48
09 45 452 1954	03.108	09 45 545 1561	03.69	09 45 600 0300	03.90	09 45 700 5068	01.48
09 45 452 1955	03.108	09 45 545 1561	03.81	09 45 600 0302	03.91	09 45 700 5073	01.48
09 45 452 1960	03.107	09 45 545 1561	03.86	09 45 600 0310	03.90	09 45 700 5075	01.48
09 45 452 1961	03.107	09 45 545 1561	03.93	09 45 600 0320	03.90	09 45 701 1534	01.40
09 45 452 1962	03.107	09 45 545 1561	03.106	09 45 600 0330	03.90	09 45 701 1536	01.40
09 45 452 1963	03.107	09 45 545 1561	04.06	09 45 600 0332	03.91	09 45 701 1538	01.40
09 45 452 1964	03.107	09 45 545 1562	03.36	09 45 600 0340	03.90	09 45 701 1543	01.40
09 45 452 1965	03.107	09 45 545 1562	03.59	09 45 600 0342	03.91	09 45 701 1545	01.40
09 45 452 1970	03.108	09 45 545 1562	03.69	09 45 600 0501	02.19	09 45 701 1545	01.40
09 45 452 1971	03.108	09 45 545 1562	03.81	09 45 600 0502	02.17	09 45 701 1564	01.40
09 45 452 1972	03.108	09 45 545 1562	03.86	09 45 600 0521	02.19	09 45 701 1566	01.40
09 45 452 1973	03.108	09 45 545 1562	03.93	09 45 600 0522	02.17	09 45 701 1568	01.40
09 45 452 1974	03.108	09 45 545 1562	03.106	09 45 600 0523	02.20	09 45 701 1573	01.40
		09 45 545 1562	04.06	09 45 600 0524	02.20	09 45 701 1575	01.40
09 45 502 0000	03.110	09 45 545 1563	03.39	09 45 600 0525	02.20	09 45 715 0023	01.17
09 45 502 0001	03.110	09 45 545 1563	03.42	09 45 600 0531	02.19	09 45 715 0025	01.17
09 45 502 0002	03.110	09 45 545 1563	03.43	09 45 600 0532	02.17	09 45 715 0027	01.17
09 45 502 0003	03.110	09 45 545 1564	03.39	09 45 600 0541	02.19	09 45 715 0051	01.17
09 45 502 0004	03.110	09 45 545 1564	03.42	09 45 600 0542	02.17	09 45 715 0053	01.17
09 45 502 0005	03.110	09 45 545 1564	03.43	09 45 600 0600	02.18	09 45 715 0064	01.17
09 45 502 0006	03.110	09 45 545 1568	03.35	09 45 600 0620	02.18	09 45 715 0066	01.17
		09 45 545 1569	03.44	09 45 600 0630	02.18	09 45 715 0068	01.17
09 45 515 0024	03.81			09 45 600 0640	02.18	09 45 715 0073	01.17
09 45 515 0024	04.07	09 45 600 0100	02.08	09 45 600 0650	02.21	09 45 715 0075	01.17
09 45 515 0027	03.93	09 45 600 0101	02.11	09 45 600 0651	02.21	09 45 715 1164	01.17
09 45 515 0028	03.93	09 45 600 0102	02.09	09 45 600 0660	02.21	09 45 715 1166	01.17
09 45 545 0028	03.68	09 45 600 0104	02.09	09 45 600 0660	02.21	09 45 715 1168	01.17
09 45 545 0032	03.68	09 45 600 0105	02.10	09 45 600 0690	05.23	09 45 715 1173	01.17
09 45 545 1120	03.36	09 45 600 0106	02.15	09 45 600 0691	05.23	09 45 715 1173	01.17
09 45 545 1120	03.59	09 45 600 0107	02.11	09 45 600 0692	05.23	09 45 715 1175	01.17
09 45 545 1120	03.69	09 45 600 0108	05.11	09 45 600 0693	05.23	09 45 715 1364	01.21

List of part numbers



Part number	Page	Part number	Page	Part number	Page	Part number	Page
09 45 715 1366	01.21	09 45 840 0004	03.65	09 45 870 0009	01.27	09 47 050 0025	01.11
09 45 715 1368	01.21	09 45 840 0005	03.65	09 45 870 0011	01.25	09 47 050 0026	01.11
09 45 715 1373	01.21	09 45 840 0006	03.65	09 45 870 0011	01.27	09 47 050 0027	01.11
09 45 715 1375	01.21	09 45 840 0007	03.65			09 47 050 0029	01.11
09 45 715 1523	01.39	09 45 840 0008	03.65			09 47 050 0045	01.11
09 45 715 1525	01.39			09 47 030 0023	01.11	09 47 050 0046	01.11
09 45 715 1527	01.39	09 45 845 0003	03.71	09 47 030 0024	01.11	09 47 050 0047	01.11
09 45 715 1551	01.39	09 45 845 0009	03.71	09 47 030 0025	01.11	09 47 050 0048	01.11
09 45 715 1553	01.39	09 45 845 0009 024	03.71	09 47 030 0026	01.11	09 47 050 0049	01.11
09 45 715 1563	01.39	09 45 845 0010	03.71	09 47 030 0027	01.11	09 47 050 0051	01.11
09 45 715 1565	01.39	09 45 845 0011 024	03.71	09 47 030 0029	01.11	09 47 050 0067	01.11
09 45 715 1567	01.39	09 45 845 0013	03.71	09 47 030 0029	01.11	09 47 050 0068	01.11
09 45 715 1572	01.39	09 45 845 0014	03.71	09 47 030 0045	01.11	09 47 050 0069	01.11
09 45 715 1574	01.39	09 45 845 0015	03.71	09 47 030 0046	01.11	09 47 050 0070	01.11
		09 45 845 0019	03.71	09 47 030 0047	01.11	09 47 050 0071	01.11
09 45 725 1323	01.21	09 45 845 0020	03.71	09 47 030 0048	01.11	09 47 050 0073	01.11
09 45 725 1325	01.21	09 45 845 1500	03.70	09 47 030 0049	01.11	09 47 050 6001	01.07
09 45 725 1327	01.21	09 45 845 1501	03.70	09 47 030 0051	01.11	09 47 050 6002	01.07
09 45 725 1351	01.21			09 47 030 0067	01.11	09 47 050 6003	01.07
09 45 725 1353	01.21	09 45 850 0001	03.29	09 47 030 0068	01.11	09 47 050 6004	01.07
09 45 725 1503	01.41	09 45 850 0001	03.31	09 47 030 0069	01.11	09 47 050 6005	01.07
09 45 725 1505	01.41	09 45 850 0001	03.34	09 47 030 0070	01.11	09 47 050 6007	01.07
09 45 725 1507	01.41	09 45 850 0001	05.14	09 47 030 0071	01.11	09 47 050 6023	01.07
09 45 725 1512	01.41	09 45 850 0002	03.29	09 47 030 0073	01.11	09 47 050 6024	01.07
09 45 725 1514	01.41	09 45 850 0002	03.31	09 47 030 4001	01.09	09 47 050 6025	01.07
09 45 725 1533	01.42	09 45 850 0002	03.34	09 47 030 4002	01.09	09 47 050 6026	01.07
09 45 725 1535	01.42	09 45 850 0002	05.14	09 47 030 4003	01.09	09 47 050 6027	01.07
09 45 725 1537	01.42	09 45 850 0003	03.29	09 47 030 4004	01.09	09 47 050 6029	01.07
09 45 725 1542	01.42	09 45 850 0003	03.31	09 47 030 4005	01.09	09 47 050 6045	01.07
09 45 725 1544	01.42	09 45 850 0003	03.34	09 47 030 4007	01.09	09 47 050 6046	01.07
		09 45 850 0003	05.14	09 47 030 4023	01.09	09 47 050 6047	01.07
09 45 771 0211	05.05	09 45 850 0005	03.29	09 47 030 4024	01.09	09 47 050 6048	01.07
09 45 771 0212	05.05	09 45 850 0005	03.31	09 47 030 4025	01.09	09 47 050 6049	01.07
09 45 771 0214	05.05	09 45 850 0005	03.34	09 47 030 4026	01.09	09 47 050 6051	01.07
09 45 771 0215	05.05	09 45 850 0005	05.14	09 47 030 4027	01.09	09 47 050 6067	01.07
09 45 771 0216	05.05	09 45 850 0007	03.29	09 47 030 4029	01.09	09 47 050 6068	01.07
09 45 771 0217	05.05	09 45 850 0007	03.31	09 47 030 4045	01.09	09 47 050 6069	01.07
09 45 771 1212	05.05	09 45 850 0007	03.34	09 47 030 4046	01.09	09 47 050 6070	01.07
09 45 771 1213	05.05	09 45 850 0007	05.14	09 47 030 4047	01.09	09 47 050 6071	01.07
09 45 771 1215	05.05	09 45 850 0008	03.29	09 47 030 4048	01.09	09 47 050 6073	01.07
09 45 771 1216	05.05	09 45 850 0008	03.31	09 47 030 4049	01.09		
09 45 771 1219	05.05	09 45 850 0008	03.34	09 47 030 4051	01.09	09 47 060 0023	01.11
09 45 771 1223	05.05	09 45 850 0008	05.14	09 47 030 4067	01.09	09 47 060 0024	01.11
		09 45 850 0009	03.29	09 47 030 4068	01.09	09 47 060 0025	01.11
09 45 800 0000	03.50	09 45 850 0009	03.31	09 47 030 4069	01.09	09 47 060 0026	01.11
09 45 800 0001	03.50	09 45 850 0009	03.34	09 47 030 4070	01.09	09 47 060 0027	01.11
09 45 800 0002	03.50	09 45 850 0009	05.14	09 47 030 4071	01.09	09 47 060 0029	01.11
09 45 800 0004	03.50	09 45 850 0010	03.29	09 47 030 4073	01.09	09 47 060 0045	01.11
09 45 800 0005	03.50	09 45 850 0010	03.31			09 47 060 0046	01.11
09 45 800 0025	03.32	09 45 850 0010	03.34	09 47 040 0023	01.11	09 47 060 0047	01.11
09 45 800 0025	03.33	09 45 850 0010	05.14	09 47 040 0024	01.11	09 47 060 0048	01.11
09 45 800 0520	03.32			09 47 040 0025	01.11	09 47 060 0049	01.11
09 45 800 0520	03.50	09 45 851 0000	03.42	09 47 040 0026	01.11	09 47 060 0051	01.11
09 45 800 0520	03.54	09 45 851 0001	03.42	09 47 040 0027	01.11	09 47 060 0067	01.11
09 45 800 0520	03.64	09 45 851 0002	03.43	09 47 040 0029	01.11	09 47 060 0068	01.11
09 45 800 0520	03.74	09 45 851 0003	03.43	09 47 040 0045	01.11	09 47 060 0069	01.11
09 45 800 0520	03.88			09 47 040 0046	01.11	09 47 060 0070	01.11
09 45 800 0520	03.94	09 45 852 0000	03.49	09 47 040 0047	01.11	09 47 060 0071	01.11
09 45 800 0530	03.30	09 45 852 0001	03.49	09 47 040 0048	01.11	09 47 060 0073	01.11
				09 47 040 0049	01.11		
09 45 815 0000	03.86	09 45 870 0002	01.25	09 47 040 0051	01.11	09 47 220 2003 018	01.48
09 45 815 1100	03.83	09 45 870 0002	01.27	09 47 040 0067	01.11	09 47 220 2005 018	01.48
09 45 815 1560	03.85	09 45 870 0003	01.25	09 47 040 0068	01.11	09 47 220 2007 018	01.48
		09 45 870 0003	01.27	09 47 040 0069	01.11	09 47 220 2012 018	01.48
09 45 820 0000	03.72	09 45 870 0006	01.25	09 47 040 0070	01.11	09 47 220 2014 018	01.48
09 45 820 0000	03.73	09 45 870 0006	01.27	09 47 040 0071	01.11		
09 45 820 0000	03.74	09 45 870 0007	01.25	09 47 040 0073	01.11		
09 45 820 0000	03.77	09 45 870 0007	01.27			09 47 474 7001	01.25
09 45 820 0000	03.78	09 45 870 0008	01.25			09 47 474 7002	01.25
09 45 820 0000	03.82	09 45 870 0008	01.27			09 47 474 7003	01.25
09 45 820 0000	03.82	09 45 870 0009	01.25			09 47 474 7004	01.25

List of part numbers



Part number	Page	Part number	Page	Part number	Page	Part number	Page
09 47 474 7005	01.25	09 47 555 5042	01.15	09 48 171 7165 100	01.38	09 48 282 8758 150	01.43
09 47 474 7006	01.25	09 47 555 5044	01.15	09 48 171 7165 200	01.38	09 48 282 8758 200	01.43
09 47 474 7007	01.25	09 47 555 5063	01.15			09 48 284 7756 010	01.44
09 47 474 7008	01.25	09 47 555 5065	01.15	09 48 220 0011 005	05.07	09 48 284 7756 020	01.44
09 47 474 7009	01.25	09 47 555 5067	01.15	09 48 220 0011 010	05.07	09 48 284 7756 030	01.44
09 47 474 7010	01.25	09 47 555 5072	01.15	09 48 220 0011 020	05.07	09 48 284 7756 050	01.44
09 47 474 7011	01.25	09 47 555 5074	01.15	09 48 220 0011 025	05.07	09 48 284 7756 070	01.44
09 47 474 7012	01.25	09 47 555 5093	01.15	09 48 220 0011 050	05.07	09 48 284 7756 100	01.44
09 47 474 7013	01.25	09 47 555 5095	01.15	09 48 220 0011 075	05.07	09 48 284 7756 150	01.44
09 47 474 7014	01.25	09 47 555 5097	01.15	09 48 220 0011 100	05.07	09 48 284 7756 200	01.44
09 47 474 7015	01.25	09 47 555 5102	01.15	09 48 220 0011 150	05.07	09 48 284 7757 010	01.44
09 47 474 7016	01.25	09 47 555 5104	01.15	09 48 220 0011 200	05.07	09 48 284 7757 020	01.44
09 47 474 7017	01.25					09 48 284 7757 030	01.44
09 47 474 7018	01.25	09 47 565 6033	01.15	09 48 222 2011 005	05.07	09 48 284 7757 050	01.44
09 47 474 7019	01.25	09 47 565 6035	01.15	09 48 222 2011 010	05.07	09 48 284 7757 070	01.44
09 47 474 7020	01.25	09 47 565 6037	01.15	09 48 222 2011 020	05.07	09 48 284 7757 100	01.44
09 47 474 7021	01.25	09 47 565 6042	01.15	09 48 222 2011 025	05.07	09 48 284 7757 150	01.44
09 47 474 7022	01.25	09 47 565 6044	01.15	09 48 222 2011 050	05.07	09 48 284 7757 200	01.44
09 47 474 7023	01.25	09 47 565 6063	01.15	09 48 222 2011 075	05.07	09 48 284 7758 010	01.44
09 47 474 7101	01.27	09 47 565 6065	01.15	09 48 222 2011 100	05.07	09 48 284 7758 020	01.44
09 47 474 7102	01.27	09 47 565 6067	01.15	09 48 222 2011 150	05.07	09 48 284 7758 030	01.44
09 47 474 7103	01.27	09 47 565 6072	01.15	09 48 222 2011 200	05.07	09 48 284 7758 050	01.44
09 47 474 7104	01.27	09 47 565 6074	01.15			09 48 284 7758 070	01.44
09 47 474 7105	01.27	09 47 565 6093	01.15	09 48 261 2749 002	01.37	09 48 284 7758 100	01.44
09 47 474 7106	01.27	09 47 565 6095	01.15	09 48 261 2749 003	01.37	09 48 284 7758 150	01.44
09 47 474 7107	01.27	09 47 565 6097	01.15	09 48 261 2749 004	01.37	09 48 284 7758 200	01.44
09 47 474 7108	01.27	09 47 565 6102	01.15	09 48 261 2749 005	01.37		
09 47 474 7109	01.27	09 47 565 6104	01.15	09 48 261 2749 007	01.37	09 48 474 7766 003	01.23
09 47 474 7110	01.27	09 47 565 7033	01.15	09 48 261 2749 010	01.37	09 48 474 7766 005	01.23
09 47 474 7111	01.27	09 47 565 7035	01.15	09 48 261 2749 015	01.37	09 48 474 7766 010	01.23
09 47 474 7112	01.27	09 47 565 7037	01.15	09 48 261 2749 020	01.37	09 48 474 7766 015	01.23
09 47 474 7113	01.27	09 47 565 7042	01.15	09 48 261 2749 025	01.37	09 48 474 7766 020	01.23
09 47 474 7114	01.27	09 47 565 7044	01.15	09 48 261 2749 030	01.37	09 48 474 7766 030	01.23
09 47 474 7115	01.27	09 47 565 7063	01.15	09 48 261 2749 050	01.37	09 48 474 7766 050	01.23
09 47 474 7116	01.27	09 47 565 7065	01.15	09 48 261 2749 075	01.37		
09 47 474 7117	01.27	09 47 565 7067	01.15	09 48 261 2749 100	01.37	09 48 636 3751 005	05.25
09 47 474 7118	01.27	09 47 565 7072	01.15			09 48 636 3751 010	05.25
09 47 474 7119	01.27	09 47 565 7074	01.15	09 48 262 6749 002	01.37	09 48 636 3751 020	05.25
09 47 474 7120	01.27	09 47 565 7093	01.15	09 48 262 6749 003	01.37	09 48 636 3751 050	05.25
09 47 474 7121	01.27	09 47 565 7095	01.15	09 48 262 6749 004	01.37	09 48 636 3751 075	05.25
09 47 474 7122	01.27	09 47 565 7097	01.15	09 48 262 6749 005	01.37	09 48 636 3751 100	05.25
09 47 474 7123	01.27	09 47 565 7102	01.15	09 48 262 6749 007	01.37		
09 47 474 7141	01.27	09 47 565 7104	01.15	09 48 262 6749 010	01.37	09 48 686 8001 005	01.05
09 47 474 7142	01.27			09 48 262 6749 015	01.37	09 48 686 8001 010	01.05
09 47 474 7143	01.27	09 47 575 7001	01.38	09 48 262 6749 020	01.37	09 48 686 8001 015	01.05
09 47 474 7144	01.27	09 47 575 7002	01.38	09 48 262 6749 025	01.37	09 48 686 8001 030	01.05
09 47 474 7145	01.27	09 47 575 7003	01.38	09 48 262 6749 030	01.37	09 48 686 8001 050	01.05
09 47 474 7146	01.27	09 47 575 7004	01.38	09 48 262 6749 030	01.37	09 48 686 8001 075	01.05
09 47 474 7147	01.27	09 47 575 7005	01.38	09 48 262 6749 050	01.37	09 48 686 8001 100	01.05
09 47 474 7148	01.27			09 48 262 6749 075	01.37	09 48 686 8001 150	01.05
09 47 474 7149	01.27	09 47 585 8001	01.38	09 48 262 6749 100	01.37	09 48 686 8001 200	01.05
09 47 474 7150	01.27	09 47 585 8002	01.38			09 48 686 8001 200	01.05
09 47 474 7151	01.27	09 47 585 8003	01.38	09 48 282 8756 005	01.43	09 48 686 8004 005	01.05
09 47 474 7152	01.27	09 47 585 8004	01.38	09 48 282 8756 010	01.43	09 48 686 8004 010	01.05
09 47 474 7153	01.27	09 47 585 8005	01.38	09 48 282 8756 050	01.43	09 48 686 8004 015	01.05
09 47 474 7154	01.27			09 48 282 8756 075	01.43	09 48 686 8004 030	01.05
09 47 474 7155	01.27			09 48 282 8756 100	01.43	09 48 686 8004 050	01.05
09 47 474 7156	01.27	09 48 022 2011 010	05.09	09 48 282 8756 150	01.43	09 48 686 8004 075	01.05
09 47 474 7157	01.27	09 48 022 2011 015	05.09	09 48 282 8756 200	01.43	09 48 686 8004 100	01.05
09 47 474 7158	01.27	09 48 022 2011 020	05.09	09 48 282 8757 005	01.43	09 48 686 8004 150	01.05
09 47 474 7159	01.27	09 48 022 2011 030	05.09	09 48 282 8757 010	01.43	09 48 686 8004 200	01.05
09 47 474 7160	01.27	09 48 022 2011 050	05.09	09 48 282 8757 050	01.43	09 48 686 8006 005	01.05
09 47 474 7161	01.27	09 48 022 2011 075	05.09	09 48 282 8757 075	01.43	09 48 686 8006 010	01.05
09 47 474 7162	01.27	09 48 022 2011 100	05.09	09 48 282 8757 100	01.43	09 48 686 8006 015	01.05
09 47 474 7163	01.27	09 48 022 2011 150	05.09	09 48 282 8757 150	01.43	09 48 686 8006 030	01.05
		09 48 022 2011 200	05.09	09 48 282 8757 200	01.43	09 48 686 8006 050	01.05
09 47 555 5033	01.15			09 48 282 8758 005	01.43	09 48 686 8006 075	01.05
09 47 555 5035	01.15	09 48 171 7165 015	01.38	09 48 282 8758 010	01.43	09 48 686 8006 100	01.05
09 47 555 5037	01.15	09 48 171 7165 030	01.38	09 48 282 8758 050	01.43	09 48 686 8006 150	01.05
		09 48 171 7165 050	01.38	09 48 282 8758 075	01.43	09 48 686 8006 200	01.05

List of part numbers



Part number	Page	Part number	Page	Part number	Page	Part number	Page
09 48 686 8007 005	01.05	09 48 932 3757 025	01.51	19 00 000 5020	03.49	19 62 000 5084	03.77
09 48 686 8007 010	01.05	09 48 932 3757 050	01.51	19 00 000 5079	03.49	19 62 000 5084	03.89
09 48 686 8007 015	01.05	09 48 932 3757 075	01.51	19 00 000 5080	03.77	19 62 003 1250	03.82
09 48 686 8007 030	01.05	09 48 932 3757 100	01.51	19 00 000 5080	03.89	19 62 003 1443	03.76
09 48 686 8007 050	01.05			19 00 000 5081	03.77	19 62 003 1443	03.89
09 48 686 8007 075	01.05			19 00 000 5081	03.89	19 62 003 1643	03.76
09 48 686 8007 100	01.05	09 57 308 0500 000	03.94	19 00 000 5082	03.77	19 62 003 1750	03.82
09 48 686 8007 150	01.05	09 57 308 0501 000	03.94	19 00 000 5082	03.89		
09 48 686 8007 200	01.05			19 00 000 5084	03.77		
		09 57 368 0512 000	03.94	19 00 000 5084	03.89		
09 48 800 0011 005	05.08	09 57 368 0513 000	03.94	19 00 000 5180	03.77	20 10 001 5211	06.39
09 48 800 0011 010	05.08			19 00 000 5180	03.89	20 10 001 5217	06.35
09 48 800 0011 020	05.08	09 57 411 0501 200	06.43	19 00 000 5181	03.77	20 10 001 5217	06.36
09 48 800 0011 025	05.08	09 57 411 0501 201	06.43	19 00 000 5181	03.89	20 10 001 5217	06.37
09 48 800 0011 050	05.08	09 57 411 0501 202	06.43	19 00 000 5182	03.77	20 10 001 5217	06.38
09 48 800 0011 075	05.08			19 00 000 5182	03.89		
09 48 800 0011 100	05.08	09 57 508 0500 000	03.97	19 00 000 5183	03.77	20 10 125 5211	06.35
09 48 800 0011 150	05.08	09 57 508 0501 000	03.97	19 00 000 5183	03.89	20 10 125 5211	06.36
09 48 800 0011 200	05.08	09 57 508 0510 000	03.97	19 00 000 5184	03.77	20 10 125 5211	06.37
		09 57 508 0511 000	03.97	19 00 000 5184	03.89	20 10 125 5211	06.38
09 48 808 0011 005	05.08			19 00 000 5185	03.77		
09 48 808 0011 010	05.08	09 57 568 0500 000	03.97	19 00 000 5185	03.89	20 10 230 5211	06.35
09 48 808 0011 020	05.08	09 57 568 0501 000	03.97			20 10 230 5211	06.36
09 48 808 0011 025	05.08	09 57 568 0510 000	03.97			20 10 230 5211	06.37
09 48 808 0011 050	05.08	09 57 568 0511 000	03.97			20 10 230 5211	06.38
09 48 808 0011 075	05.08			19 15 503 5290	04.05		
09 48 808 0011 100	05.08			19 15 503 1402	04.05		
09 48 808 0011 150	05.08						
09 48 808 0011 200	05.08	09 62 003 0301	03.82			20 80 001 9911	06.42
		09 62 003 0306	03.82				
09 48 868 6569 xxx	01.28			19 20 003 0220	03.82		
09 48 868 6570 xxx	01.28			19 20 003 0227	03.82		
09 48 868 6571 xxx	01.28			19 20 003 0423	03.76	20 82 000 0001	03.15
09 48 868 6572 xxx	01.28	09 67 000 3476	03.19	19 20 003 0423	03.89	20 82 000 0001	03.16
09 48 868 6573 xxx	01.28	09 67 000 3576	03.19	19 20 003 0426	03.89	20 82 000 0001	03.22
		09 67 000 5476	03.19	19 20 003 0623	03.76	20 82 000 0001	03.23
09 48 878 7584 xxx	01.29	09 67 000 5476	05.31	19 20 003 0623	03.89	20 82 000 0001	03.34
09 48 878 7585 xxx	01.29	09 67 000 5476	05.33	19 20 003 0626	03.76	20 82 000 0001	03.37
09 48 878 7586 xxx	01.29	09 67 000 5576	03.19	19 20 003 0626	03.89	20 82 000 0001	03.40
09 48 878 7587 xxx	01.29	09 67 000 5576	05.31	19 20 003 0626	03.89	20 82 000 0001	03.42
09 48 878 7588 xxx	01.29	09 67 000 5576	05.33	19 20 003 0720	03.82	20 82 000 0001	03.43
09 48 878 7589 xxx	01.29	09 67 000 5576	05.33	19 20 003 0727	03.82	20 82 000 0001	03.45
09 48 878 7590 xxx	01.29	09 67 000 7476	03.19	19 20 003 1252	03.82	20 82 000 0001	03.46
		09 67 000 7476	05.31	19 20 003 1443	03.76	20 82 000 0001	03.55
		09 67 000 7476	05.33	19 20 003 1443	03.89	20 82 000 0001	03.106
09 48 888 8574 xxx	01.31	09 67 000 7576	03.19	19 20 003 1643	03.76	20 82 000 0002	03.37
09 48 888 8575 xxx	01.31	09 67 000 7576	05.31	19 20 003 1750	03.82	20 82 000 0002	03.59
09 48 888 8576 xxx	01.31	09 67 000 7576	05.33			20 82 000 0002	03.69
09 48 888 8577 xxx	01.31	09 67 000 8476	03.19			20 82 000 0002	03.86
09 48 888 8578 xxx	01.31	09 67 000 8476	05.31	19 37 003 1250	03.82	20 82 000 0002	03.106
09 48 888 8579 xxx	01.31	09 67 000 8476	05.33	19 37 003 1443	03.76	20 82 000 0002	04.06
09 48 888 8580 xxx	01.31	09 67 000 8576	03.19	19 37 003 1443	03.89	20 82 000 0003	03.15
09 48 888 8592 xxx	01.31	09 67 000 8576	05.31	19 37 003 1643	03.76	20 82 000 0003	03.16
		09 67 000 8576	05.33	19 37 003 1750	03.82	20 82 000 0003	03.22
09 48 898 9593 xxx	01.30					20 82 000 0003	03.23
09 48 898 9594 xxx	01.30					20 82 000 0003	03.34
09 48 898 9595 xxx	01.30					20 82 000 0003	03.37
09 48 898 9596 xxx	01.30	09 99 000 0382	03.50	19 44 000 5082	03.77	20 82 000 0003	03.40
09 48 898 9597 xxx	01.30	09 99 000 0384	03.19	19 44 000 5082	03.89	20 82 000 0003	03.42
09 48 898 9598 xxx	01.30	09 99 000 0501	03.19	19 44 003 0301	03.82	20 82 000 0003	03.43
		09 99 000 0501	03.26	19 44 003 1250	03.82	20 82 000 0003	03.45
09 48 932 3756 005	01.51	09 99 000 0501	03.50	19 44 003 1443	03.76	20 82 000 0003	03.46
09 48 932 3756 010	01.51	09 99 000 0525	03.26	19 44 003 1443	03.89	20 82 000 0003	03.55
09 48 932 3756 015	01.51	09 99 000 0531	03.19	19 44 003 1643	03.76	20 82 000 0003	03.106
09 48 932 3756 020	01.51	09 99 000 0646	03.19			20 82 000 0005	03.16
09 48 932 3756 025	01.51	09 99 000 0646	03.26			20 82 000 0005	03.22
09 48 932 3756 050	01.51			19 62 000 5080	03.77	20 82 000 0005	03.23
09 48 932 3756 075	01.51			19 62 000 5080	03.89	20 82 000 0005	03.34
09 48 932 3756 100	01.51			19 62 000 5081	03.77	20 82 000 0005	03.37
09 48 932 3757 005	01.51			19 62 000 5081	03.89	20 82 000 0005	03.40
09 48 932 3757 010	01.51			19 62 000 5082	03.77	20 82 000 0005	03.43
09 48 932 3757 015	01.51	10 12 005 1004	03.93	19 62 000 5082	03.89		
09 48 932 3757 020	01.51	10 12 005 2001	03.88	19 62 000 5082	03.89		

List of part numbers



Part number	Page	Part number	Page	Part number	Page	Part number	Page
20 82 000 0005	03.45	20 82 405 0001	03.41	21 01 010 2017	03.19	21 33 050 0855 020	01.50
20 82 000 0005	03.46	20 82 500 0001	03.40	21 01 100 9014	03.26	21 33 050 0855 030	01.50
20 82 000 0005	03.55	20 82 500 0001	03.42	21 01 100 9019	03.26	21 33 050 0855 050	01.50
20 82 000 0005 XL	03.16	20 82 500 0001	03.43			21 33 050 0855 100	01.50
20 82 000 0005 XL	03.22	20 82 500 0002	03.40			21 33 050 5850 010	01.50
20 82 000 0005 XL	03.23			21 03 281 1405	03.06	21 33 050 5850 020	01.50
20 82 000 0005 XL	03.34	20 82 501 0001	03.40	21 03 281 2405	03.07	21 33 050 5850 030	01.50
20 82 000 0005 XL	03.37	20 82 501 0001	03.42			21 33 050 5850 050	01.50
20 82 000 0005 XL	03.40	20 82 501 0001	03.43	21 03 282 1405	03.06	21 33 050 5850 100	01.50
20 82 000 0005 XL	03.43			21 03 282 2405	03.07	21 33 050 5853 005	05.27
20 82 000 0005 XL	03.45	20 82 600 2002	01.35			21 33 050 5853 010	05.27
20 82 000 0005 XL	03.46	20 82 600 2004	01.35	21 03 381 1425	03.08	21 33 050 5853 020	05.27
20 82 000 0005 XL	03.55	20 82 600 2006	01.35	21 03 381 2401	03.18	21 33 050 5853 025	05.27
20 82 000 0005 XL	03.55	20 82 600 2008	01.35	21 03 381 2425	03.09	21 33 050 5853 050	05.27
20 82 000 1210	03.15	20 82 600 2010	01.35	21 03 381 2800	03.25	21 33 050 5853 075	05.27
20 82 000 1210	03.22	20 82 600 2020	01.35	21 03 381 4401	03.18	21 33 050 5853 100	05.27
20 82 000 9901	03.15	20 82 600 2030	01.35	21 03 381 4800	03.25	21 33 050 5853 150	05.27
20 82 000 9901	03.16	20 82 600 2040	01.35	21 03 381 6401	03.17	21 33 050 5853 200	05.27
20 82 000 9901	03.22	20 82 600 2050	01.35	21 03 381 6402	03.17	21 33 050 5855 010	01.50
20 82 000 9901	03.23	20 82 600 2100	01.35	21 03 381 6402	03.24	21 33 050 5855 020	01.50
20 82 000 9901	03.34			21 03 381 6815	03.24	21 33 050 5855 030	01.50
20 82 000 9901	03.37	20 82 601 1002	01.35			21 33 050 5855 050	01.50
20 82 000 9901	03.40	20 82 601 1004	01.35	21 03 881 1405	03.12	21 33 050 5855 100	01.50
20 82 000 9901	03.45	20 82 601 1006	01.35	21 03 881 1405	05.12		
20 82 000 9901	03.46	20 82 601 1008	01.35	21 03 881 1430	05.13		
20 82 000 9901	03.49	20 82 601 1010	01.35	21 03 881 1805	03.20	21 33 070 0853 003	01.52
20 82 000 9901	03.55	20 82 601 1020	01.35	21 03 881 1805	05.24		
20 82 000 9901	03.106	20 82 601 1030	01.35	21 03 881 2405	03.13	21 33 080 0850 003	01.52
20 82 000 9915	03.49	20 82 601 1040	01.35	21 03 881 2425	05.17		
20 82 000 9916	03.36	20 82 601 1050	01.35	21 03 881 2805	03.21	21 33 232 3401 010	05.10
20 82 000 9916	03.39	20 82 601 1100	01.35	21 03 881 2825	05.17	21 33 232 3401 015	05.10
20 82 000 9916	03.49			21 03 881 3405	03.12	21 33 232 3401 020	05.10
20 82 000 9916	03.106	20 82 630 2002	01.13	21 03 881 3405	03.12	21 33 232 3401 030	05.10
		20 82 630 2004	01.13	21 03 881 3805	03.20	21 33 232 3401 050	05.10
20 82 001 0001	03.37	20 82 630 2006	01.13	21 03 881 4405	03.13	21 33 232 3401 100	05.10
20 82 001 0001	03.59	20 82 630 2008	01.13	21 03 881 4805	03.21		
20 82 001 0001	03.69	20 82 630 2010	01.13			21 33 290 0853 005	05.29
20 82 001 0001	03.81	20 82 630 2020	01.13	21 03 882 1411	05.16	21 33 290 0853 010	05.29
20 82 001 0001	03.86	20 82 630 2030	01.13	21 03 882 1415	03.10	21 33 290 0853 020	05.29
20 82 001 0001	03.93	20 82 630 2040	01.13	21 03 882 1425	03.14	21 33 290 0853 025	05.29
20 82 001 0001	03.106	20 82 630 2050	01.13	21 03 882 2405	03.11	21 33 290 0853 050	05.29
20 82 001 0001	04.06	20 82 630 2050	01.13	21 03 882 2411	05.16	21 33 290 0853 075	05.29
20 82 001 0002	03.37	20 82 630 2100	01.13	21 03 882 2425	03.14	21 33 290 0853 100	05.29
20 82 001 0002	03.59			21 03 882 3405	03.10	21 33 290 0853 150	05.29
20 82 001 0002	03.69	20 82 631 1002	01.12	21 03 882 3405	05.12	21 33 290 0853 200	05.29
20 82 001 0002	03.86	20 82 631 1004	01.12				
20 82 001 0002	03.106	20 82 631 1006	01.12			21 33 292 9853 005	05.29
20 82 001 0002	04.06	20 82 631 1008	01.12			21 33 292 9853 010	05.29
		20 82 631 1010	01.12	21 33 010 1853 005	05.27	21 33 292 9853 020	05.29
20 82 002 0001	03.76	20 82 631 1020	01.12	21 33 010 1853 010	05.27	21 33 292 9853 025	05.29
20 82 002 0001	04.05	20 82 631 1030	01.12	21 33 010 1853 020	05.27	21 33 292 9853 050	05.29
		20 82 631 1040	01.12	21 33 010 1853 025	05.27	21 33 292 9853 075	05.29
20 82 005 0001	03.15	20 82 631 1050	01.12	21 33 010 1853 050	05.27	21 33 292 9853 100	05.29
20 82 005 0002	03.22	20 82 631 1100	01.12	21 33 010 1853 075	05.27	21 33 292 9853 150	05.29
20 82 005 1214	03.15			21 33 010 1853 100	05.27	21 33 292 9853 200	05.29
20 82 005 2001	03.16			21 33 010 1853 150	05.27		
		20 99 000 1099	06.42	21 33 010 1853 200	05.27	21 33 390 0413 005	05.07
20 82 006 1218	03.22	20 99 000 3013	06.42			21 33 390 0413 010	05.07
20 82 006 2001	03.23	20 99 000 3016	06.42	21 33 050 0850 010	01.50	21 33 390 0413 020	05.07
				21 33 050 0850 020	01.50	21 33 390 0413 025	05.07
20 82 007 1100	03.46			21 33 050 0850 030	01.50	21 33 390 0413 050	05.07
				21 33 050 0850 050	01.50	21 33 390 0413 075	05.07
20 82 101 0001	03.45			21 33 050 0850 100	01.50	21 33 390 0413 100	05.07
20 82 101 0010	03.34			21 33 050 0853 005	05.27	21 33 390 0413 150	05.07
				21 33 050 0853 010	05.27	21 33 390 0413 200	05.07
20 82 102 0101	03.84	21 01 000 0003	03.27	21 33 050 0853 020	05.27		
		21 01 000 0018	03.19	21 33 050 0853 025	05.27		
20 82 104 0001	03.55	21 01 000 0018	03.26	21 33 050 0853 050	05.27	21 34 920 0405 005	01.47
20 82 104 0045	03.55	21 01 000 0030	03.27	21 33 050 0853 075	05.27	21 34 920 0405 010	01.47
20 82 104 0101	03.62	21 01 000 0031	03.27	21 33 050 0853 100	05.27	21 34 920 0405 015	01.47
		21 01 000 0033	03.27	21 33 050 0853 150	05.27	21 34 920 0405 020	01.47
20 82 204 0001	03.55	21 01 000 0036	03.17	21 33 050 0853 200	05.27	21 34 920 0405 050	01.47
		21 01 000 0036	03.24	21 33 050 0855 010	01.50		
20 82 400 0001	03.38						
20 82 400 0002	03.41						

List of part numbers



Part number	Page	Part number	Page	Part number	Page	Part number	Page
21 34 920 0405 100	01.47	33 01 241 0010 005	06.07	33 01 241 0090 009	06.11	33 53 211 0100 002	06.33
21 34 920 0477 005	01.47	33 01 241 0010 006	06.07	33 01 241 0090 027	06.08	33 53 211 0200 001	06.33
21 34 920 0477 010	01.47	33 01 241 0010 007	06.07	33 01 241 0090 033	06.11	33 53 211 0200 002	06.33
21 34 920 0477 015	01.47	33 01 241 0010 008	06.11	33 01 241 0090 034	06.08		
21 34 920 0477 020	01.47	33 01 241 0010 009	06.11	33 01 241 0100 005	06.07		
21 34 920 0477 050	01.47	33 01 241 0010 027	06.08	33 01 241 0100 006	06.07	33 54 211 0010 001	06.23
21 34 920 0477 075	01.47	33 01 241 0010 033	06.11	33 01 241 0100 007	06.07	33 54 211 0010 002	06.24
21 34 920 0477 100	01.47	33 01 241 0010 034	06.08	33 01 241 0100 008	06.11	33 54 211 0050 001	06.23
		33 01 241 0020 005	06.07	33 01 241 0100 009	06.11	33 54 211 0050 002	06.24
		33 01 241 0020 006	06.07	33 01 241 0100 027	06.08	33 54 211 0100 001	06.23
21 34 929 2405 005	01.47	33 01 241 0020 007	06.07	33 01 241 0100 033	06.11	33 54 211 0100 002	06.24
21 34 929 2405 010	01.47	33 01 241 0020 008	06.11	33 01 241 0100 034	06.08	33 54 211 0200 001	06.23
21 34 929 2405 015	01.47	33 01 241 0020 009	06.11			33 54 211 0200 002	06.24
21 34 929 2405 020	01.47	33 01 241 0020 027	06.08			33 54 211 0400 001	06.23
21 34 929 2405 050	01.47	33 01 241 0020 033	06.11	33 02 211 0010 001	06.31	33 54 211 0400 002	06.24
21 34 929 2405 075	01.47	33 01 241 0020 034	06.08	33 02 211 0020 001	06.31	33 54 211 0500 001	06.23
21 34 929 2405 100	01.47	33 01 241 0030 005	06.07	33 02 211 0050 001	06.31	33 54 211 0500 002	06.24
21 34 929 2477 005	01.47	33 01 241 0030 006	06.07	33 02 211 0100 001	06.31	33 54 211 1000 001	06.23
21 34 929 2477 010	01.47	33 01 241 0030 007	06.07	33 02 211 0200 001	06.31	33 54 211 1000 002	06.24
21 34 929 2477 015	01.47	33 01 241 0030 008	06.11			33 54 751 0100 001	06.23
21 34 929 2477 020	01.47	33 01 241 0030 009	06.11			33 54 751 0100 002	06.24
21 34 929 2477 050	01.47	33 01 241 0030 027	06.08	33 04 211 xxx0 001	06.47	33 54 751 0200 001	06.23
21 34 929 2477 075	01.47	33 01 241 0030 033	06.11	33 04 211 xxx0 002	06.47	33 54 751 0200 002	06.24
21 34 929 2477 100	01.47	33 01 241 0030 034	06.08	33 04 211 xxx0 003	06.47	33 54 751 1000 001	06.23
21 34 929 3405 005	01.47	33 01 241 0040 005	06.07	33 04 211 xxx0 004	06.47	33 54 751 1000 002	06.24
21 34 929 3405 010	01.47	33 01 241 0040 006	06.07				
21 34 929 3405 015	01.47	33 01 241 0040 007	06.07	33 04 411 0010 001	06.48		
21 34 929 3405 020	01.47	33 01 241 0040 008	06.11	33 04 411 0010 002	06.48	33 57 111 0010 001	03.95
21 34 929 3405 050	01.47	33 01 241 0040 009	06.11	33 04 411 0010 003	06.48	33 57 111 0010 002	03.95
21 34 929 3405 075	01.47	33 01 241 0040 027	06.08	33 04 411 0010 004	06.48	33 57 111 0015 001	06.28
21 34 929 3405 100	01.47	33 01 241 0040 033	06.11	33 04 411 0010 005	06.48	33 57 111 0015 002	06.28
21 34 929 3477 005	01.47	33 01 241 0040 034	06.08	33 04 411 0010 006	06.48	33 57 111 0015 003	06.27
21 34 929 3477 010	01.47	33 01 241 0050 005	06.07	33 04 411 0010 007	06.48	33 57 111 0015 004	06.27
21 34 929 3477 015	01.47	33 01 241 0050 006	06.07	33 04 411 0010 008	06.48	33 57 111 0050 001	03.95
21 34 929 3477 020	01.47	33 01 241 0050 007	06.07			33 57 111 0050 002	03.95
21 34 929 3477 050	01.47	33 01 241 0050 008	06.11	33 11 000 0179 000	06.43	33 57 111 0055 001	06.28
21 34 929 3477 075	01.47	33 01 241 0050 009	06.11	33 11 000 0180 000	06.43	33 57 111 0055 002	06.28
21 34 929 3477 100	01.47	33 01 241 0050 027	06.08			33 57 111 0055 003	06.27
		33 01 241 0050 033	06.11			33 57 111 0055 004	06.27
		33 01 241 0050 034	06.08	33 25 231 xxx0 001	06.46	33 57 111 0100 001	03.95
21 34 930 0405 005	01.47	33 01 241 0060 005	06.07			33 57 111 0100 002	03.95
21 34 930 0405 010	01.47	33 01 241 0060 006	06.07			33 57 111 0105 001	06.28
21 34 930 0405 015	01.47	33 01 241 0060 007	06.07			33 57 111 0105 002	06.28
21 34 930 0405 020	01.47	33 01 241 0060 008	06.11	33 26 231 xxx0 011	06.45	33 57 111 0105 003	06.27
21 34 930 0405 050	01.47	33 01 241 0060 009	06.11	33 26 231 xxx0 012	06.44	33 57 111 0105 004	06.27
21 34 930 0405 075	01.47	33 01 241 0060 027	06.08	33 26 231 xxx0 013	06.44	33 57 111 0200 001	03.95
21 34 930 0405 100	01.47	33 01 241 0060 033	06.11	33 26 231 xxx0 014	06.44	33 57 111 0200 002	03.95
21 34 930 0477 005	01.47	33 01 241 0060 034	06.08	33 26 231 xxx0 015	06.45	33 57 111 0205 001	06.28
21 34 930 0477 010	01.47	33 01 241 0070 005	06.07	33 26 231 xxx0 016	06.45	33 57 111 0205 002	06.28
21 34 930 0477 015	01.47	33 01 241 0070 006	06.07	33 26 231 xxx0 017	06.45	33 57 111 0205 003	06.27
21 34 930 0477 020	01.47	33 01 241 0070 007	06.07	33 26 231 xxx0 018	06.44	33 57 111 0205 004	06.27
21 34 930 0477 050	01.47	33 01 241 0070 008	06.11			33 57 111 0405 001	06.28
21 34 930 0477 075	01.47	33 01 241 0070 009	06.11	33 45 232 0050 003	01.45	33 57 111 0405 002	06.28
21 34 930 0477 100	01.47	33 01 241 0070 027	06.08	33 45 232 0100 003	01.45	33 57 111 0405 003	06.27
		33 01 241 0070 033	06.11	33 45 232 0200 003	01.45	33 57 111 0405 004	06.27
		33 01 241 0070 034	06.08	33 45 232 0300 003	01.45	33 57 111 0505 001	06.28
21 34 949 4405 005	01.47	33 01 241 0080 005	06.07	33 45 232 0500 003	01.45	33 57 111 0505 002	06.28
21 34 949 4405 010	01.47	33 01 241 0080 006	06.07	33 45 232 0750 003	01.45	33 57 111 0505 003	06.27
21 34 949 4405 015	01.47	33 01 241 0080 007	06.07	33 45 232 1000 003	01.45	33 57 111 0505 004	06.27
21 34 949 4405 020	01.47	33 01 241 0080 008	06.11			33 57 111 1005 001	06.28
21 34 949 4405 050	01.47	33 01 241 0080 009	06.11			33 57 111 1005 002	06.28
21 34 949 4405 075	01.47	33 01 241 0080 027	06.08	33 53 211 0010 001	06.33	33 57 111 1005 003	06.27
21 34 949 4405 100	01.47	33 01 241 0080 033	06.11	33 53 211 0010 002	06.33	33 57 111 1005 004	06.27
21 34 949 4477 005	01.47	33 01 241 0080 034	06.08	33 53 211 0020 001	06.33		
21 34 949 4477 010	01.47	33 01 241 0080 034	06.08	33 53 211 0020 002	06.33	33 57 211 0010 001	03.95
21 34 949 4477 015	01.47	33 01 241 0090 005	06.07	33 53 211 0020 001	06.33	33 57 211 0010 002	03.95
21 34 949 4477 020	01.47	33 01 241 0090 006	06.07	33 53 211 0050 001	06.33	33 57 211 0015 001	06.28
21 34 949 4477 050	01.47	33 01 241 0090 007	06.07	33 53 211 0050 002	06.33	33 57 211 0015 002	06.28
21 34 949 4477 075	01.47	33 01 241 0090 008	06.11	33 53 211 0100 001	06.33	33 57 211 0015 003	06.27
21 34 949 4477 100	01.47						

List of part numbers



Part number	Page	Part number	Page	Part number	Page	Part number	Page
33 57 211 0015 004	06.27	33 58 751 1000 003	06.14	33 61 221 0500 001	06.13	33 61 431 0090 003	06.18
33 57 211 0050 001	03.95	33 58 751 1000 003	06.17	33 61 221 0500 002	06.14	33 61 431 0090 004	06.19
33 57 211 0050 002	03.95	33 58 751 1000 003	06.20	33 61 221 0500 003	06.15	33 61 431 0090 005	06.20
33 57 211 0055 001	06.28			33 61 221 0600 001	06.13	33 61 431 0090 006	06.21
33 57 211 0055 002	06.28			33 61 221 0600 002	06.14	33 61 431 0100 001	06.16
33 57 211 0055 003	06.27			33 61 221 0600 003	06.15	33 61 431 0100 002	06.17
33 57 211 0055 004	06.27	33 61 221 0010 001	06.13	33 61 221 0700 001	06.13	33 61 431 0100 003	06.18
33 57 211 0100 001	03.95	33 61 221 0010 002	06.14	33 61 221 0700 002	06.14	33 61 431 0100 004	06.19
33 57 211 0100 002	03.95	33 61 221 0010 003	06.15	33 61 221 0700 003	06.15	33 61 431 0100 005	06.20
33 57 211 0105 001	06.28	33 61 221 0020 001	06.13	33 61 221 0800 001	06.13	33 61 431 0100 006	06.21
33 57 211 0105 002	06.28	33 61 221 0020 002	06.14	33 61 221 0800 002	06.14	33 61 431 0110 001	06.16
33 57 211 0105 003	06.27	33 61 221 0020 003	06.15	33 61 221 0800 003	06.15	33 61 431 0110 002	06.17
33 57 211 0105 004	06.27	33 61 221 0030 001	06.13	33 61 221 0900 001	06.13	33 61 431 0110 003	06.18
33 57 211 0200 001	03.95	33 61 221 0030 002	06.14	33 61 221 0900 002	06.14	33 61 431 0110 004	06.19
33 57 211 0200 002	03.95	33 61 221 0030 003	06.15	33 61 221 0900 003	06.15	33 61 431 0110 005	06.20
33 57 211 0205 001	06.28	33 61 221 0040 001	06.13	33 61 221 1000 001	06.13	33 61 431 0110 006	06.21
33 57 211 0205 002	06.28	33 61 221 0040 002	06.14	33 61 221 1000 002	06.14	33 61 431 0120 001	06.16
33 57 211 0205 003	06.27	33 61 221 0040 003	06.15	33 61 221 1000 003	06.15	33 61 431 0120 002	06.17
33 57 211 0205 004	06.27	33 61 221 0050 001	06.13			33 61 431 0120 003	06.18
33 57 211 0405 001	06.28	33 61 221 0050 002	06.14	33 61 431 0010 001	06.16	33 61 431 0120 004	06.19
33 57 211 0405 002	06.28	33 61 221 0050 003	06.15	33 61 431 0010 002	06.17	33 61 431 0120 005	06.20
33 57 211 0405 003	06.27	33 61 221 0060 001	06.13	33 61 431 0010 003	06.18	33 61 431 0120 006	06.21
33 57 211 0405 004	06.27	33 61 221 0060 002	06.14	33 61 431 0010 004	06.19	33 61 431 0130 001	06.16
33 57 211 0505 001	06.28	33 61 221 0060 003	06.15	33 61 431 0010 005	06.20	33 61 431 0130 002	06.17
33 57 211 0505 002	06.28	33 61 221 0070 001	06.13	33 61 431 0010 006	06.21	33 61 431 0130 003	06.18
33 57 211 0505 003	06.27	33 61 221 0070 002	06.14	33 61 431 0020 001	06.16	33 61 431 0130 004	06.19
33 57 211 0505 004	06.27	33 61 221 0070 003	06.15	33 61 431 0020 002	06.17	33 61 431 0130 005	06.20
33 57 211 1005 001	06.28	33 61 221 0080 001	06.13	33 61 431 0020 003	06.18	33 61 431 0130 006	06.21
33 57 211 1005 002	06.28	33 61 221 0080 002	06.14	33 61 431 0020 004	06.19	33 61 431 0140 001	06.16
33 57 211 1005 003	06.27	33 61 221 0080 003	06.15	33 61 431 0020 005	06.20	33 61 431 0140 002	06.17
33 57 211 1005 004	06.27	33 61 221 0090 001	06.13	33 61 431 0020 006	06.21	33 61 431 0140 003	06.18
		33 61 221 0090 002	06.14	33 61 431 0030 001	06.16	33 61 431 0140 004	06.19
33 57 851 0100 001	03.96	33 61 221 0090 003	06.15	33 61 431 0030 002	06.17	33 61 431 0140 005	06.20
33 57 851 0100 002	06.28	33 61 221 0100 001	06.13	33 61 431 0030 003	06.18	33 61 431 0140 006	06.21
33 57 851 0100 004	06.27	33 61 221 0100 002	06.14	33 61 431 0030 004	06.19	33 61 431 0150 001	06.16
33 57 851 0200 001	03.96	33 61 221 0100 003	06.15	33 61 431 0030 005	06.20	33 61 431 0150 002	06.17
33 57 851 0200 002	06.28	33 61 221 0110 001	06.13	33 61 431 0030 006	06.21	33 61 431 0150 003	06.18
33 57 851 0200 004	06.27	33 61 221 0110 002	06.14	33 61 431 0040 001	06.16	33 61 431 0150 004	06.19
33 57 851 0300 001	03.96	33 61 221 0110 003	06.15	33 61 431 0040 002	06.17	33 61 431 0150 005	06.20
33 57 851 1000 001	03.96	33 61 221 0120 001	06.13	33 61 431 0040 003	06.18	33 61 431 0150 006	06.21
33 57 851 5000 001	03.96	33 61 221 0120 002	06.14	33 61 431 0040 004	06.19	33 61 431 0200 001	06.16
33 57 851 5000 002	06.28	33 61 221 0120 003	06.15	33 61 431 0040 005	06.20	33 61 431 0200 002	06.17
33 57 851 5000 004	06.27	33 61 221 0130 001	06.13	33 61 431 0040 006	06.21	33 61 431 0200 003	06.18
		33 61 221 0130 002	06.14	33 61 431 0050 001	06.16	33 61 431 0200 004	06.19
		33 61 221 0130 003	06.15	33 61 431 0050 002	06.17	33 61 431 0200 005	06.20
33 58 751 0100 001	06.15	33 61 221 0140 001	06.13	33 61 431 0050 003	06.18	33 61 431 0200 006	06.21
33 58 751 0100 001	06.18	33 61 221 0140 002	06.14	33 61 431 0050 004	06.19	33 61 431 0250 001	06.16
33 58 751 0100 001	06.21	33 61 221 0140 003	06.15	33 61 431 0050 005	06.20	33 61 431 0250 002	06.17
33 58 751 0100 002	06.13	33 61 221 0150 001	06.13	33 61 431 0060 001	06.16	33 61 431 0250 003	06.18
33 58 751 0100 002	06.16	33 61 221 0150 002	06.14	33 61 431 0060 002	06.17	33 61 431 0250 004	06.19
33 58 751 0100 002	06.19	33 61 221 0150 003	06.15	33 61 431 0060 003	06.18	33 61 431 0250 005	06.20
33 58 751 0100 003	06.14	33 61 221 0200 001	06.13	33 61 431 0060 004	06.19	33 61 431 0250 006	06.21
33 58 751 0100 003	06.17	33 61 221 0200 002	06.14	33 61 431 0060 005	06.20	33 61 431 0300 001	06.16
33 58 751 0100 003	06.20	33 61 221 0200 003	06.15	33 61 431 0060 006	06.21	33 61 431 0300 002	06.17
33 58 751 0200 001	06.15	33 61 221 0250 001	06.13	33 61 431 0070 001	06.16	33 61 431 0300 003	06.18
33 58 751 0200 001	06.18	33 61 221 0250 002	06.14	33 61 431 0070 002	06.17	33 61 431 0300 004	06.19
33 58 751 0200 001	06.21	33 61 221 0250 003	06.15	33 61 431 0070 003	06.18	33 61 431 0300 005	06.20
33 58 751 0200 002	06.13	33 61 221 0300 001	06.13	33 61 431 0070 004	06.19	33 61 431 0300 006	06.21
33 58 751 0200 002	06.16	33 61 221 0300 002	06.14	33 61 431 0070 005	06.20	33 61 431 0350 001	06.16
33 58 751 0200 002	06.19	33 61 221 0300 003	06.15	33 61 431 0070 006	06.21	33 61 431 0350 002	06.17
33 58 751 0200 003	06.14	33 61 221 0350 001	06.13	33 61 431 0080 001	06.16	33 61 431 0350 003	06.18
33 58 751 0200 003	06.17	33 61 221 0350 002	06.14	33 61 431 0080 002	06.17	33 61 431 0350 004	06.19
33 58 751 0200 003	06.20	33 61 221 0350 003	06.15	33 61 431 0080 003	06.18	33 61 431 0350 005	06.20
33 58 751 1000 001	06.15	33 61 221 0400 001	06.13	33 61 431 0080 004	06.19	33 61 431 0350 006	06.21
33 58 751 1000 001	06.18	33 61 221 0400 002	06.14	33 61 431 0080 005	06.20	33 61 431 0400 001	06.16
33 58 751 1000 001	06.21	33 61 221 0400 003	06.15	33 61 431 0080 006	06.21	33 61 431 0400 002	06.17
33 58 751 1000 002	06.13	33 61 221 0450 001	06.13	33 61 431 0090 001	06.16	33 61 431 0400 003	06.18
33 58 751 1000 002	06.16	33 61 221 0450 002	06.14	33 61 431 0090 002	06.17	33 61 431 0400 004	06.19
33 58 751 1000 002	06.19	33 61 221 0450 003	06.15				

List of part numbers



Part number	Page	Part number	Page	Part number	Page	Part number	Page
33 61 431 0400 005	06.20	61 03 000 0067	05.22	61 03 001 3019	05.41		
33 61 431 0400 006	06.21	61 03 000 0068	05.22	61 03 001 3118	05.42		
33 61 431 0450 001	06.16	61 03 000 0069	05.22	61 03 001 3118 010	05.42		
33 61 431 0450 002	06.17	61 03 000 0070	05.22	61 03 001 3119	05.42		
33 61 431 0450 003	06.18	61 03 000 0071	05.22	61 03 001 3119 010	05.42		
33 61 431 0450 004	06.19	61 03 000 0072	05.22				
33 61 431 0450 005	06.20	61 03 000 0127	05.22				
33 61 431 0450 006	06.21	61 03 000 0141	05.22	61 04 201 1084	03.61		
33 61 431 0500 001	06.16	61 03 000 0142	05.22	61 04 600 0182	03.61		
33 61 431 0500 002	06.17	61 03 000 0143	05.22				
33 61 431 0500 003	06.18	61 03 000 0165	05.22				
33 61 431 0500 004	06.19	61 03 000 0166	05.22				
33 61 431 0500 005	06.20			66 63 009 5013	05.40		
33 61 431 0500 006	06.21	61 03 001 0010	05.41	66 63 009 5014	05.40		
33 61 431 0600 001	06.16	61 03 001 0010 010	05.41				
33 61 431 0600 002	06.17	61 03 001 0011	05.43				
33 61 431 0600 003	06.18	61 03 001 0012	05.43	66 67 009 0346	05.42		
33 61 431 0600 004	06.19	61 03 001 0013	05.41	66 67 009 0347	05.42		
33 61 431 0600 005	06.20	61 03 001 0013 010	05.41				
33 61 431 0600 006	06.21	61 03 001 0014	05.41				
33 61 431 0700 001	06.16	61 03 001 0015	05.41				
33 61 431 0700 002	06.17	61 03 001 0016	05.41				
33 61 431 0700 003	06.18	61 03 001 0017	05.41				
33 61 431 0700 004	06.19	61 03 001 0018	05.41				
33 61 431 0700 005	06.20	61 03 001 0019	05.41				
33 61 431 0700 006	06.21	61 03 001 0020	05.43				
33 61 431 0800 001	06.16	61 03 001 0021	05.43				
33 61 431 0800 002	06.17	61 03 001 0022	05.43				
33 61 431 0800 003	06.18	61 03 001 0118	05.42				
33 61 431 0800 004	06.19	61 03 001 0118 010	05.42				
33 61 431 0800 005	06.20	61 03 001 0119	05.42				
33 61 431 0800 006	06.21	61 03 001 0119 010	05.42				
33 61 431 0900 001	06.16	61 03 001 1010	05.41				
33 61 431 0900 002	06.17	61 03 001 1010 010	05.41				
33 61 431 0900 003	06.18	61 03 001 1013	05.41				
33 61 431 0900 004	06.19	61 03 001 1013 010	05.41				
33 61 431 0900 005	06.20	61 03 001 1014	05.41				
33 61 431 0900 006	06.21	61 03 001 1015	05.41				
33 61 431 1000 001	06.16	61 03 001 1016	05.41				
33 61 431 1000 002	06.17	61 03 001 1017	05.41				
33 61 431 1000 003	06.18	61 03 001 1018	05.41				
33 61 431 1000 004	06.19	61 03 001 1019	05.41				
33 61 431 1000 005	06.20	61 03 001 1118	05.42				
33 61 431 1000 006	06.21	61 03 001 1118 010	05.42				
		61 03 001 1119	05.42				
		61 03 001 1119 010	05.42				
		61 03 001 2010	05.41				
		61 03 001 2010 010	05.41				
61 03 000 0044	05.22	61 03 001 2013	05.41				
61 03 000 0045	05.22	61 03 001 2013 010	05.41				
61 03 000 0046	05.22	61 03 001 2014	05.41				
61 03 000 0047	05.22	61 03 001 2015	05.41				
61 03 000 0048	05.22	61 03 001 2016	05.41				
61 03 000 0049	05.22	61 03 001 2017	05.41				
61 03 000 0050	05.22	61 03 001 2018	05.41				
61 03 000 0051	05.22	61 03 001 2019	05.41				
61 03 000 0052	05.22	61 03 001 2118	05.42				
61 03 000 0053	05.22	61 03 001 2118 010	05.42				
61 03 000 0054	05.22	61 03 001 2119	05.42				
61 03 000 0055	05.22	61 03 001 2119 010	05.42				
61 03 000 0056	05.22	61 03 001 3010	05.41				
61 03 000 0057	05.22	61 03 001 3010 010	05.41				
61 03 000 0058	05.22	61 03 001 3013	05.41				
61 03 000 0059	05.22	61 03 001 3013 010	05.41				
61 03 000 0062	05.22	61 03 001 3014	05.41				
61 03 000 0063	05.22	61 03 001 3015	05.41				
61 03 000 0064	05.22	61 03 001 3016	05.41				
61 03 000 0065	05.22	61 03 001 3017	05.41				
61 03 000 0066	05.22	61 03 001 3018	05.41				



Distributors – worldwide



ARROW: www.arrow.com
Digi-Key Corporation: www.digikey.com
Farnell: www.farnell.com
FUTURE Electronics:
www.futureelectronics.com
Mouser Electronics: www.mouser.com
RS Components: www.rs-components.com

Other countries and general contact



HARTING
Electric GmbH & Co. KG
P.O. Box 1473
D-32328 Espelkamp
Germany
Phone +49 5772/47-97100
electric@HARTING.com
www.HARTING.com

HARTING
Electronics GmbH
P.O. Box 1433
32328 Espelkamp
Germany
Phone +49 5772/47-97200
electronics@HARTING.com
www.HARTING.com



Pushing Performance

HARTING.com –
the gateway to your
country website.

www.HARTING.ae
www.HARTING.at
www.HARTING.com.au
www.HARTING.be
www.HARTING.com.br
www.HARTING.ca
www.HARTING.ch
www.HARTING.com.cn
www.HARTING.cz
www.HARTING.de
www.HARTING.dk
www.HARTING.es
www.HARTING.fi
www.HARTING.fr
www.HARTING.co.uk
www.HARTING.com.hk
www.HARTING.hu
www.HARTING.co.in
www.HARTING.it
www.HARTING.co.jp
www.HARTING.co.kr
www.HARTINGbv.nl
www.HARTING.no
www.HARTING.pl
www.HARTING.pt
www.HARTING.ro
www.HARTING.ru
www.HARTING.se
www.HARTING.sg
www.HARTING.sk
www.HARTING.com.tr
www.HARTING.com.tw
www.HARTING-USA.com
www.HARTING.co.za

HARTING Technology Group

info@HARTING.com

www.HARTING.com

www.product-news.HARTING.com