

Fiber Optic Solutions for Industrial Applications

Edition 2022

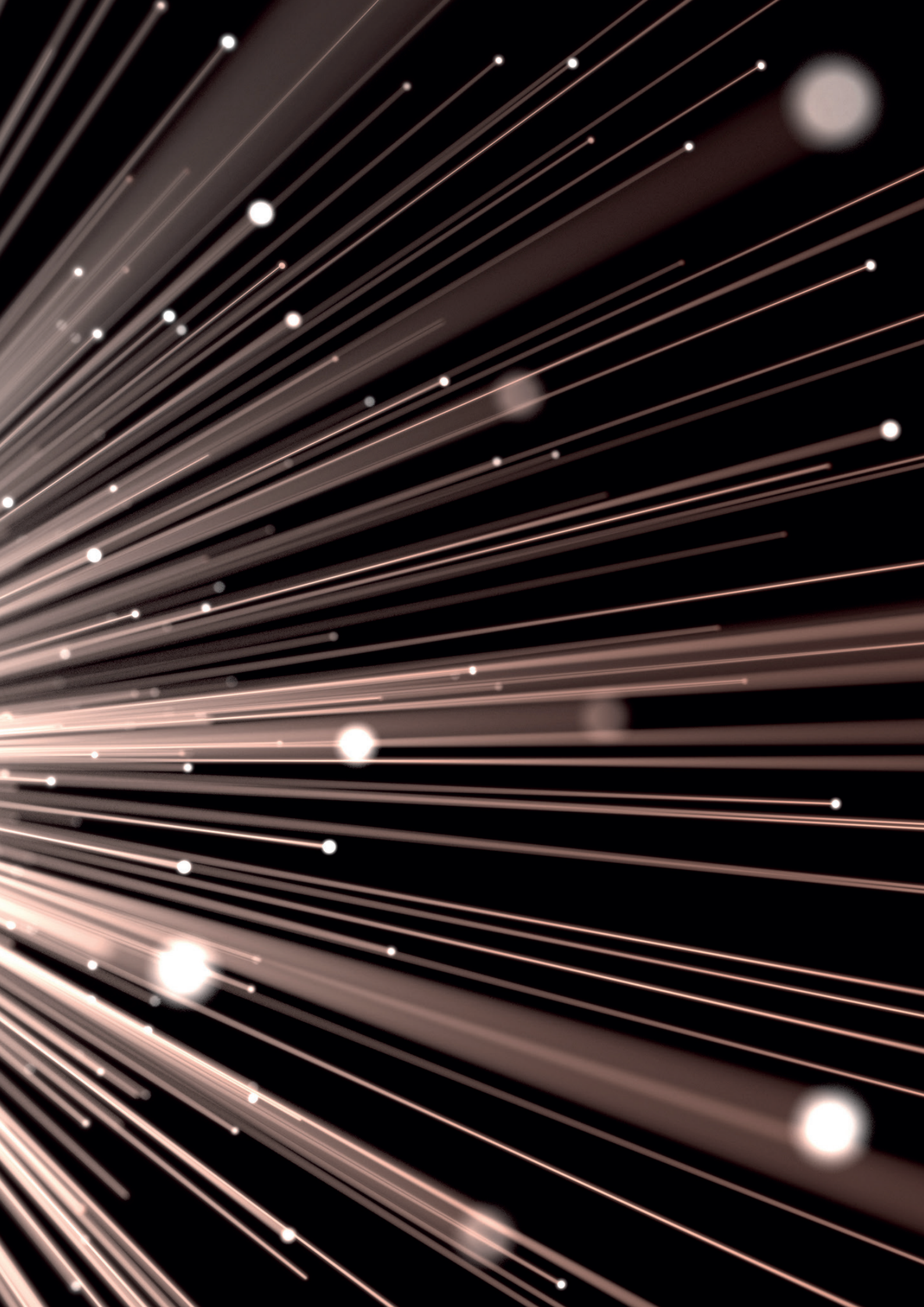

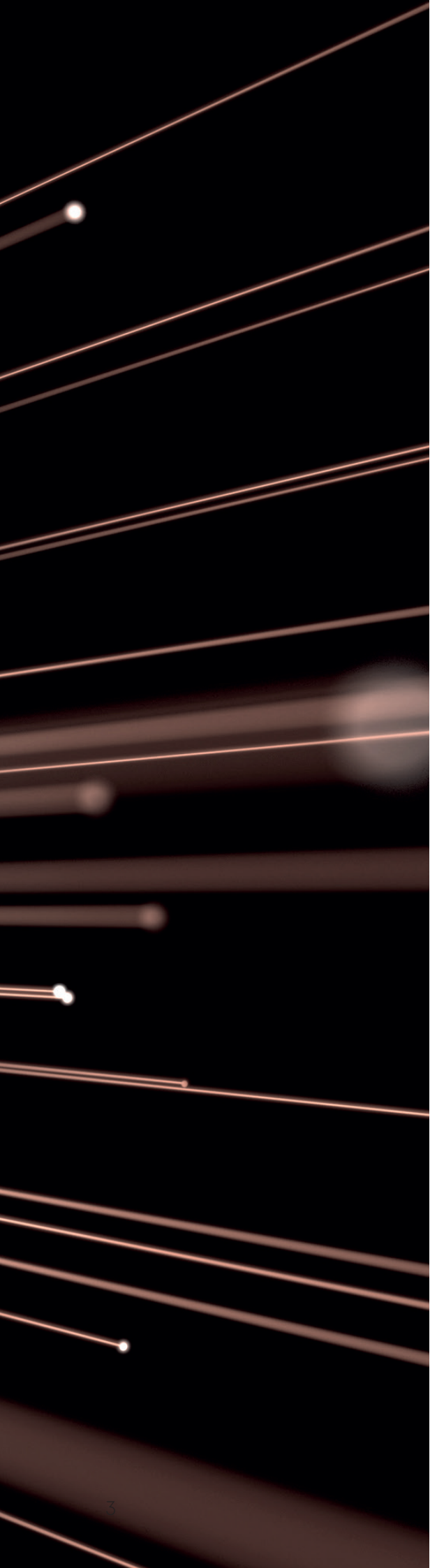



About HUBER+SUHNER

As the fourth industrial revolution progresses, data connectivity takes a more pivotal role: information stemming from sensors, data-heavy automation solutions and data analytics must be conveyed across large distances and through challenging environments. High bandwidths and low latencies become must-haves.

Against this backdrop, fiber optic networks are critical enablers. The boundaries between industries are blurring and fiber optic connectivity solutions that bridge device, data processing units and control systems find broad adoption across many sectors. The common denominator in implementing fiber optics is the drive to increase productivity, cost efficiency, innovation, power and safety.

Highly robust, flexible, and easy-to-deploy data links are essential to keep pace with the rapid evolution of technology, business models and evermore demanding application environments.

HUBER+SUHNER provides a broad industry portfolio and delivers quality field-proven products, as well as expertly customized solutions for your specific needs. Our fiber optic offering for industrial applications is complemented by radio frequency and low-frequency products, expanding the toolbox to provide you with the best solutions.

Wind power

HUBER+SUHNER develops state-of-the-art fiber optic cables and connectors that support data exchange from the tip of the blade to the base of the tower, and throughout the wind park. A dense network of sensors and high-end controllers place turbines under real-time control – hence it is critical to ensure the integrity of the data transfer.

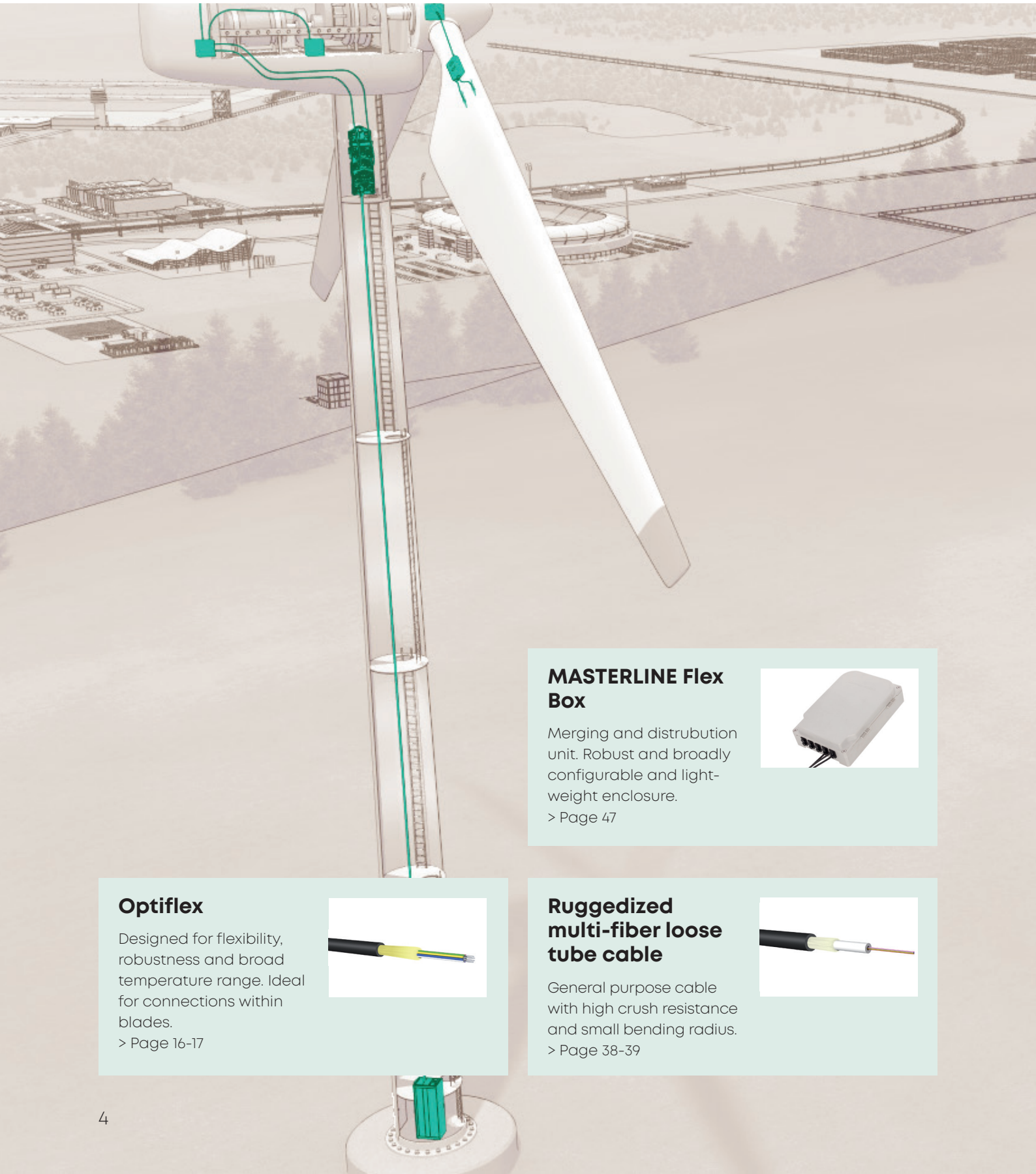

MASTERLINE Flex Box

Merging and distribution unit. Robust and broadly configurable and light-weight enclosure.

> Page 47



Optiflex

Designed for flexibility, robustness and broad temperature range. Ideal for connections within blades.

> Page 16-17

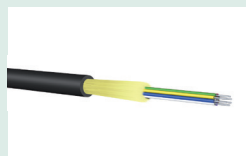

Ruggedized multi-fiber loose tube cable

General purpose cable with high crush resistance and small bending radius.

> Page 38-39

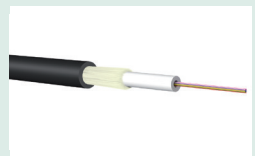

Cables and connectors from HUBER+SUHNER are designed to withstand the harsh environments of both onshore and offshore installations, enabling easy and safe installation. The biggest wind turbines in the world and the top wind turbine OEMs have relied on HUBER+SUHNER connectivity for more than a decade.



Q-ODC mini

Two-core quick-lock connector for harsh environments with the smallest form factor.
> Page 67-68



Q-ODC-2, 12/24

Quick-lock connectors for 2 to 24 fibers made for challenging environments.

- Q-ODC-2 > Page 69-71
- Q-ODC-2 assemblies > Page 92-96
- Q-ODC-12/24 > Page 74-75
- Q-ODC-12/24 industry > Page 76-77
- Q-ODC-12/24 assemblies > Page 97



Q-XCO

Ruggedized quick-lock plastic connector with LC interface. Connects directly into SFP module.
> Page 59-62



Masterline Ultimate (MLUQ)

Tower-down connection system.
> Page 102-103



Power transmission and distribution

HUBER+SUHNER has been providing fiber optics solutions to the global power transmission & distribution market for many years, keeping in pace with the latest market needs and innovative trends.

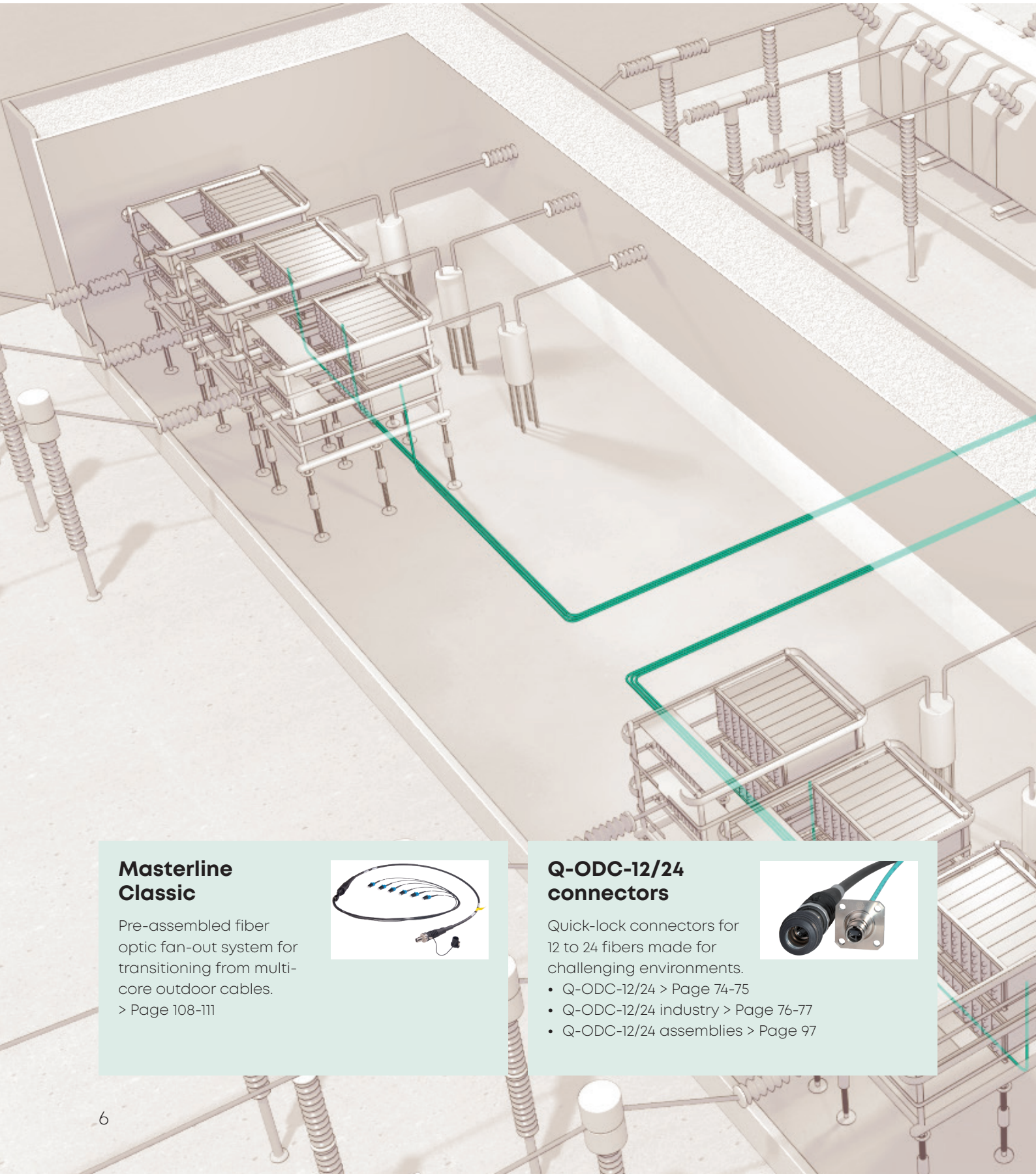

Masterline Classic

Pre-assembled fiber optic fan-out system for transitioning from multi-core outdoor cables.
> Page 108-111



Q-ODC-12/24 connectors

Quick-lock connectors for 12 to 24 fibers made for challenging environments.

- Q-ODC-12/24 > Page 74-75
- Q-ODC-12/24 industry > Page 76-77
- Q-ODC-12/24 assemblies > Page 97



Our approach is to provide end-to-end solutions comprising of specialized cables, rugged connectors and clever fiber distribution hubs. Our ability to customize and build-to-order using a comprehensive, yet flexible component toolbox lets utilities and OEMs profit from ease of installation, longevity and perfect application fit.

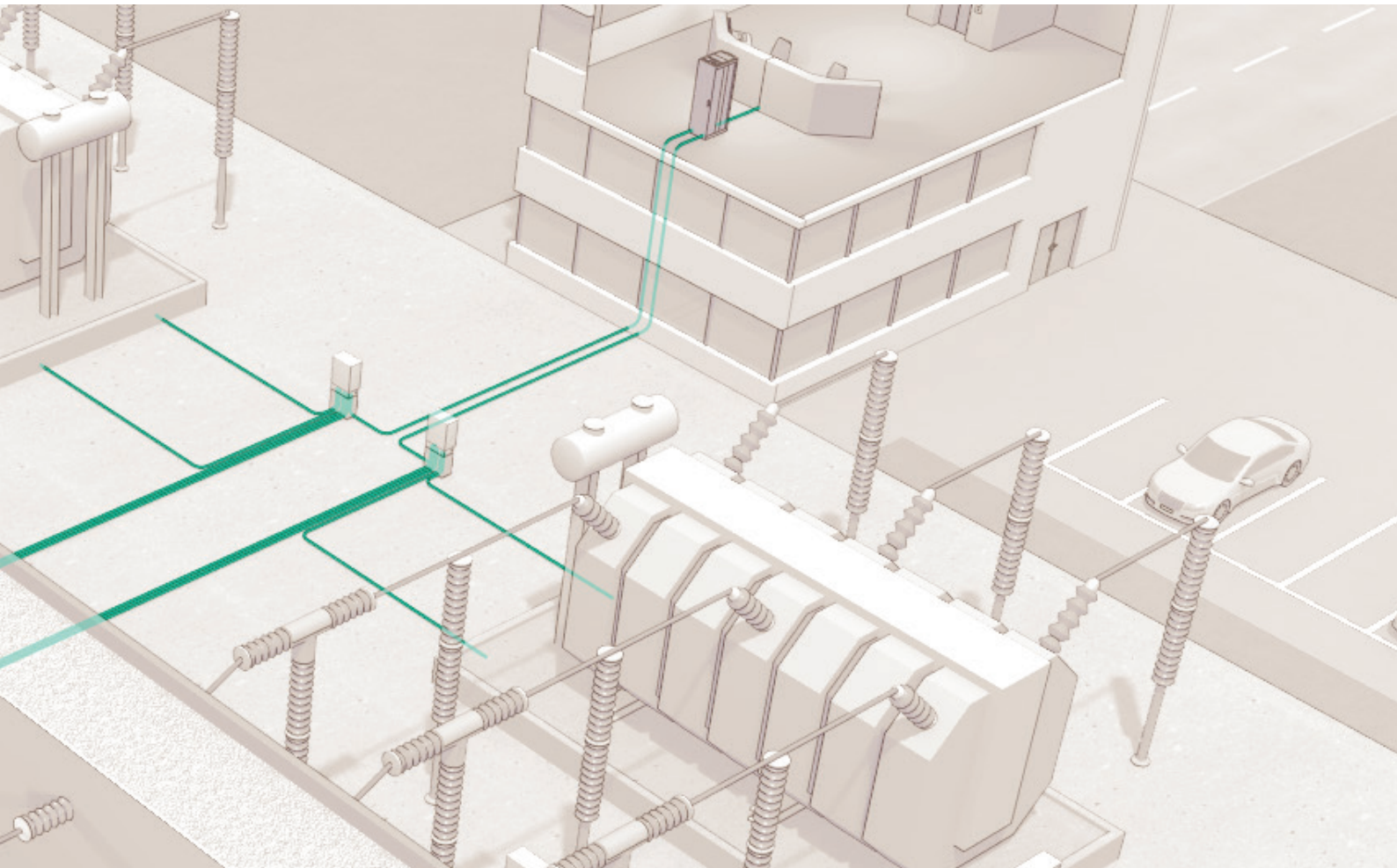

HDM box

Rack-mounted metallic patch module for translating QODC 12/24 to LC/SC/E200 connectors.
> Page 45



ODC-4 connectors

Compact four-core outdoor screw-type connector for switchgear instrumentation.
> Page 65



HVDC cable

Aramide- and metal-free cable for high-voltage environments. Designed for valve control in HVDC converter stations.
> Page 26-27



MONOLITH Box Medium

DIN rail mounted splice/patch module ideal for cabinets in the switchyard. Translates to SC/LC/E2000.
> Page 44



Mining

In a world of deeper mines, rising energy costs and infrastructure shortages, mining companies remain under extraordinary pressure to control costs, increase efficiency and improve safety performance.

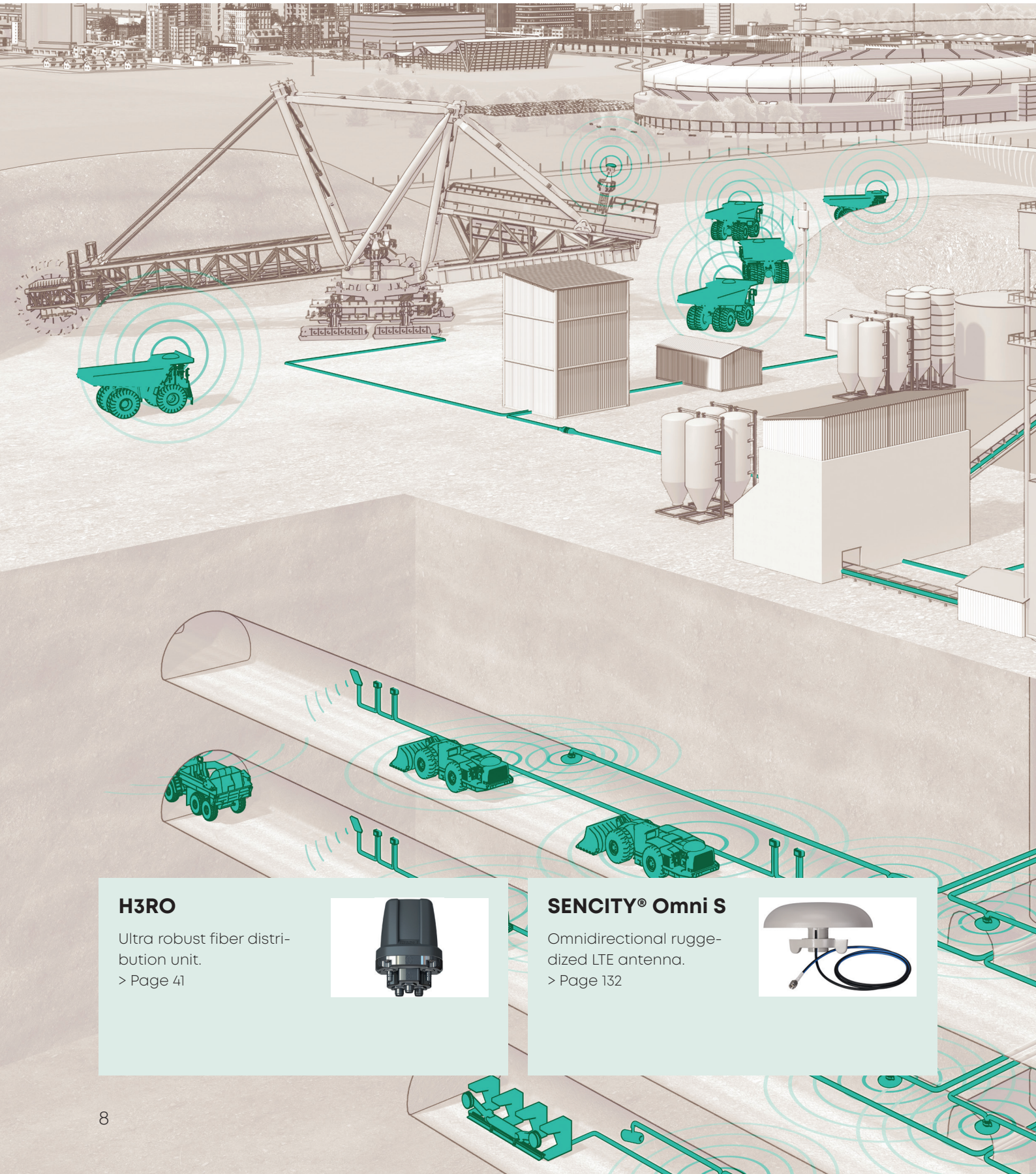

H3RO

Ultra robust fiber distribution unit.
> Page 41



SENCITY® Omni S

Omnidirectional ruggedized LTE antenna.
> Page 132



HUBER+SUHNER supplies components and system solutions that enable optical and radio frequency connectivity in the harsh environments of the mining and tunneling industry – solutions that uniquely combine customizability, robustness and ease of installation.

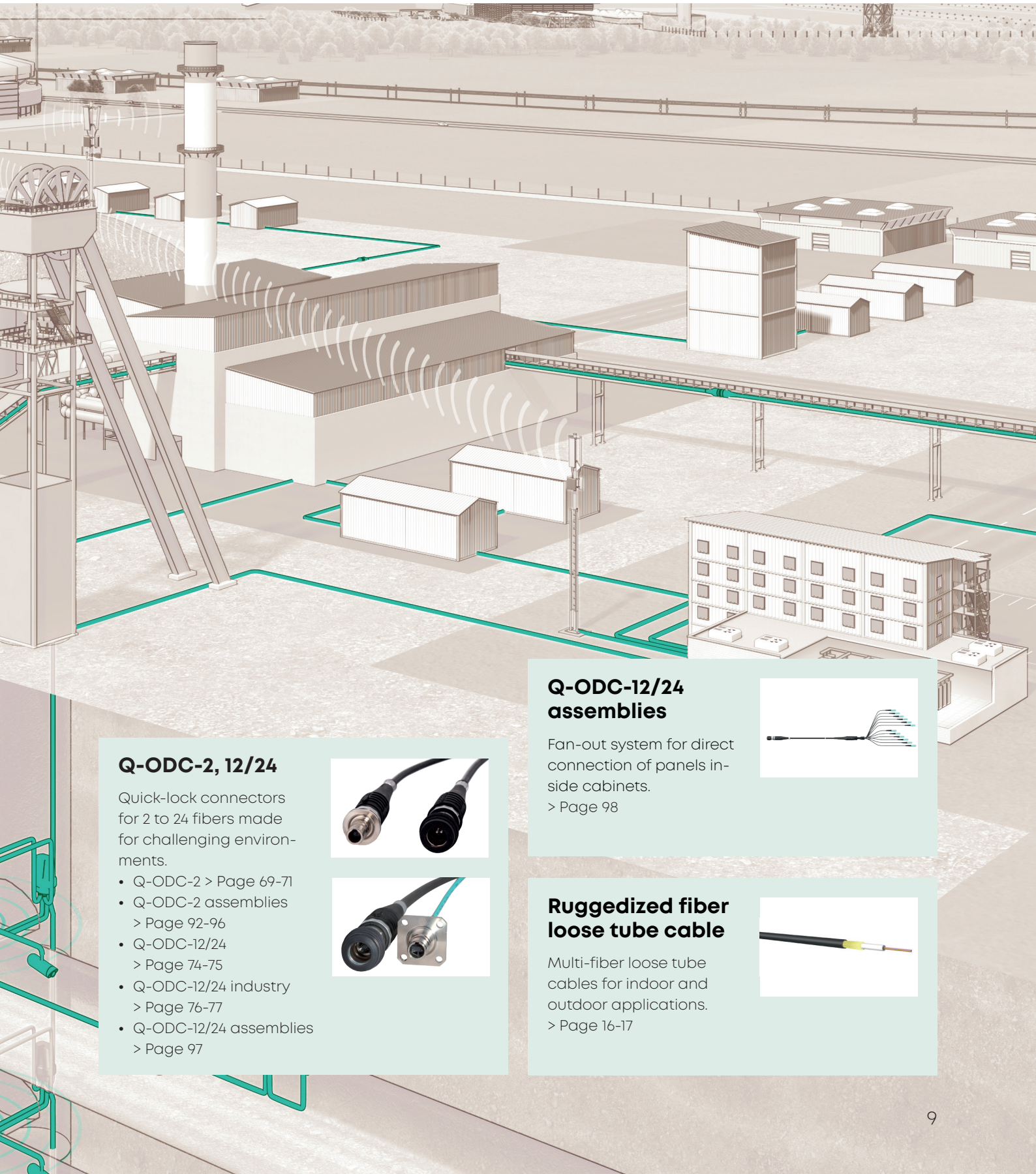

Q-ODC-2, 12/24

Quick-lock connectors for 2 to 24 fibers made for challenging environments.

- Q-ODC-2 > Page 69-71
- Q-ODC-2 assemblies > Page 92-96
- Q-ODC-12/24 > Page 74-75
- Q-ODC-12/24 industry > Page 76-77
- Q-ODC-12/24 assemblies > Page 97



Q-ODC-12/24 assemblies

Fan-out system for direct connection of panels inside cabinets.

> Page 98



Ruggedized fiber loose tube cable

Multi-fiber loose tube cables for indoor and outdoor applications.

> Page 16-17



Industrial Automation

The vision of a production environment in which production and logistics systems can largely operate themselves without human intervention is becoming reality. The „IoT“ and „Industrie 4.0“ have become buzzwords. These terms mean that a product carries its production information in machine-readable form so that the production system and the various production steps can be controlled and monitored.

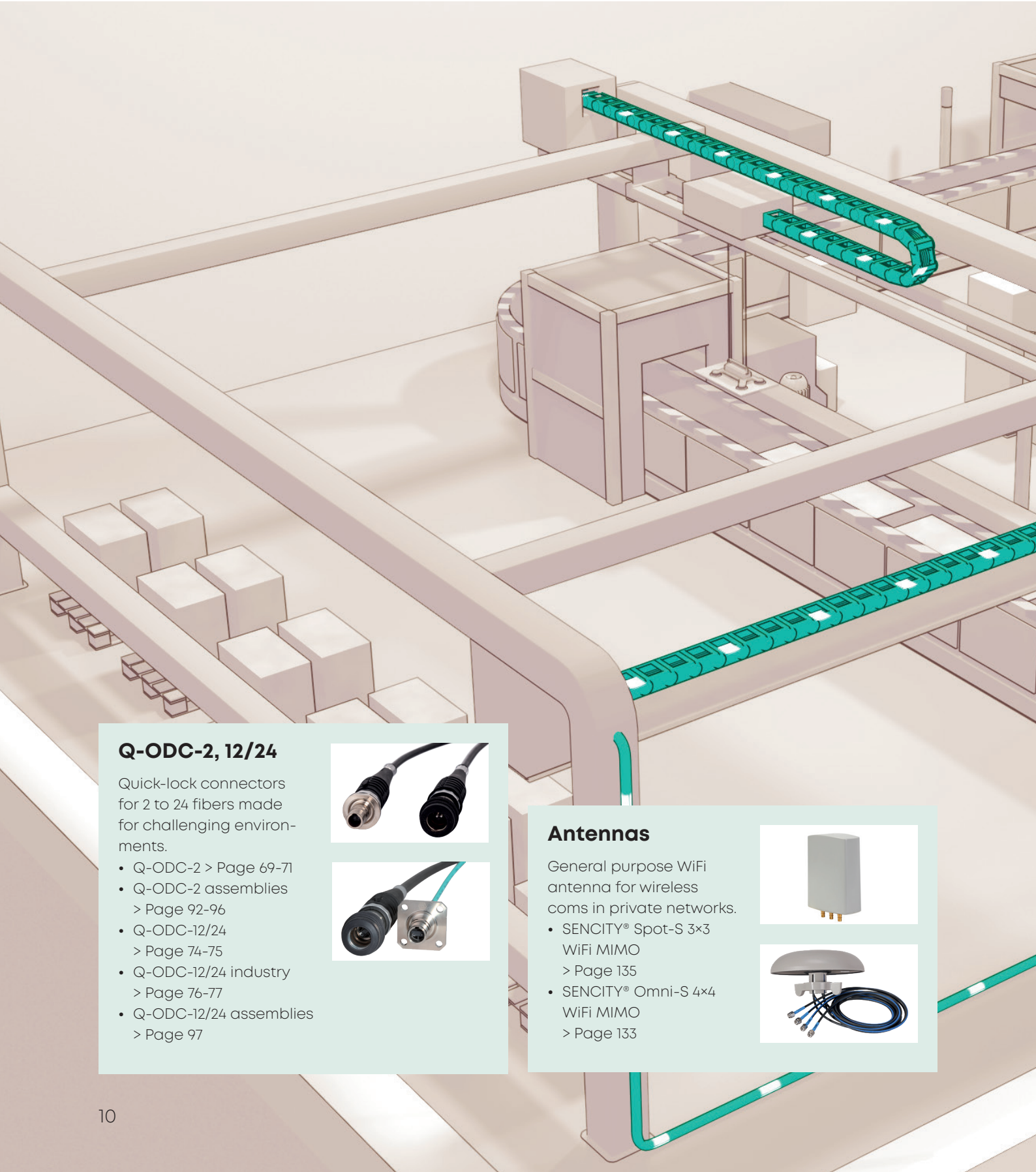

Q-ODC-2, 12/24

Quick-lock connectors for 2 to 24 fibers made for challenging environments.

- Q-ODC-2 > Page 69-71
- Q-ODC-2 assemblies > Page 92-96
- Q-ODC-12/24 > Page 74-75
- Q-ODC-12/24 industry > Page 76-77
- Q-ODC-12/24 assemblies > Page 97



Antennas

General purpose WiFi antenna for wireless coms in private networks.

- SENCITY® Spot-S 3x3 WiFi MIMO > Page 135
- SENCITY® Omni-S 4x4 WiFi MIMO > Page 133



As this trend becomes progressively more wide-spread, interference-free data transmission becomes even more important. HUBER+SUHNER's wireless and cable solutions satisfy these high demands. Whether robust antennas or coaxial, fiber optic or data cables, these products are an important link between the various sensors, control units, and provide a reliable connection to the control system.

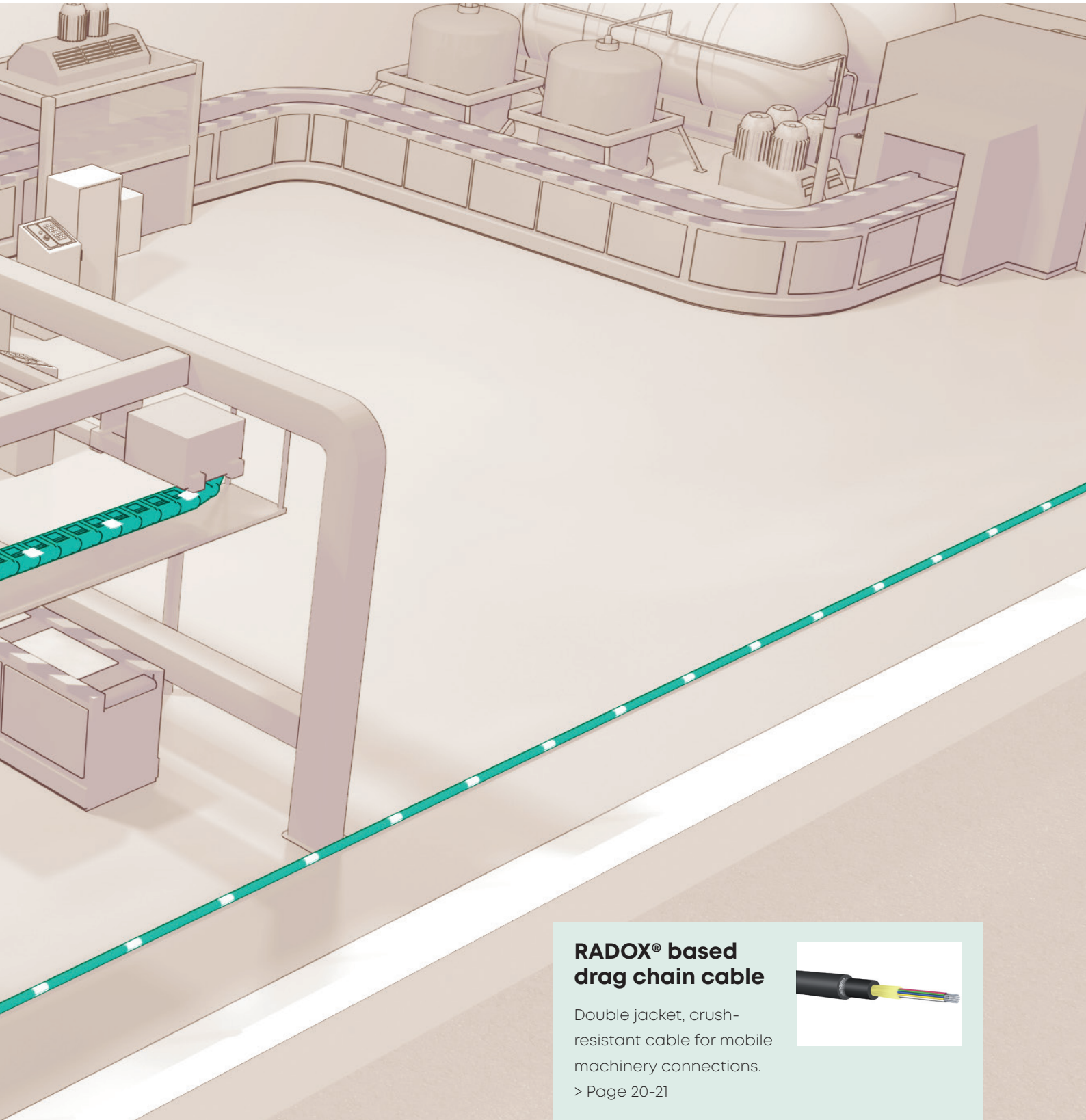

RADOX® based drag chain cable

Double jacket, crush-resistant cable for mobile machinery connections.

> Page 20-21

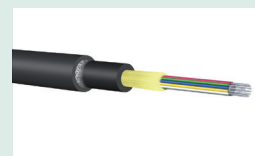

FO cables

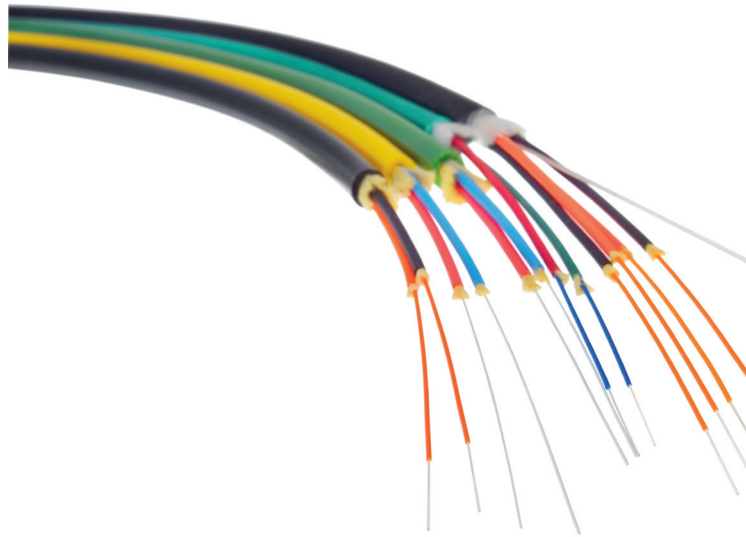

HUBER+SUHNER offers a wide range of fiber optic cables, optimised for fixed or mobile applications for indoor and outdoor use. Our innovative products are developed and tested to meet stringent international standards regarding mechanical and thermal conditions, as well as fire/flame resistance.

[Go to external document/link ↗](#)

Mobile field cables

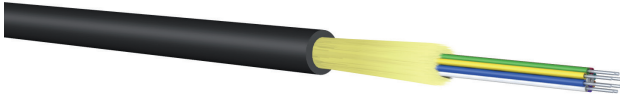

Properties

- High tensile strength
- For direct connector assembly
- Excellent coiling capability
- High chemical resistance against acids and alkalis
- For high mechanical and thermal stability
- Halogen free and non-corrosive fire gases
- Improved crush resistance
- UV-protected, suitable for outdoor use
- Metal free
- Easy stripping
- High tensile strength, high abrasion and cut resistance

Applications

- Fixed or mobile data cabling (MASTERLINE mobile)
- Data cabling for harsh environment
- Military tactical field use
- Field video broadcast
- Machine cabling, drag chains

Design

Cable design	2, 4, 8 and 12 tight tubes
Strain relief	aramide yarn
Jacket material	TPU
Jacket colour	black

According to IEC 60794-1-2

Ordering information

02-.../FSN(ZN)Z-...56
04-.../FSN(ZN)Z-...56
08-.../FSN(ZN)Z-...68
12-.../FSN(ZN)Z-...80

Mobile field cables

Specification						
Number of Fiber		2	4	8	12	
Jacket Ø	mm	5.6	5.6	6.8	8.0	
Tube Ø	mm	0.9	0.9	0.9	0.9	coloured
Approx. weight	kg/km	24	26	40	53	

Mechanical properties								
Tensile strength	during installation	N	4000	4000	4000	4000	IEC 60794-1-2 E1	
	in service	N	2000	2000	2000	2000		
Min. bend radius	during installation	mm	90	90	90	120	IEC 60794-1-2 E11	
	in service	mm	45	45	45	80		
Crush resistance	short-term	E9 G50	N/dm	21 000 19 000	21 000 19 000	21 000 19 000	IEC 60794-1-2 E3	
	long-term	E9 G50	N/dm	6000 8000	6000 8000	6000 2000 2000		
Repeated bending	r=50 mm, weight = 2 kg r=80 mm, weight = 5 kg		cycles	20 000	20 000	20 000	20 000	IEC 60794-1-2 E6
Flexing	r=100 mm, weight = 1 kg r=120 mm, weight = 2 kg r=80 mm, weight = 1.5 kg		cycles	100 000	100 000	100 000	100 000	IEC 60794-1-2 E8
Impact resistance	Wp = 2.21 J		im- pacts	300	300	300	300	IEC 60794-1-2 E4
Coiling capability	length= 500 m/r=45 mm length= 500 m/r=80 mm length= 100 m/r=80 mm		cycles	5	5	5	5	HUBER+SUHNER
Torsion	± 1440°, l = 1000 mm ± 360°, l = 1000 mm		cycles	1000	1000	1000	1000	IEC 60794-1-2 F5B IEC 60794-1-2 E7

Thermal properties					
Temperature range	during installation	°C	-45 to +85		IEC 60794-1-22 F1
	in service	°C	-60 to +85		
	in storage	°C	-60 to +85		

Combustion properties						
Fire load	MJ/m	0.5	0.5	0.75	0.7	
2011/65/EC (RoHS)		compliant				

p = passed

Optiflex



Properties

- For direct connector assembly
- Strain relief with aramide yarn
- UV-protected, suitable for outdoor use
- Metal-free
- High abrasive resistance

Applications

- Data cabling for harsh environment
- Military tactical field use
- Field video broadcast

Design

Cable design	Loose tube cable with flexible loose tube, jelly-filled, with 2 to 12 fibers
Strain relief	Aramide yarn
Fiber colour	According to colour code
Jacket material	TPU
Jacket colour	black

According to IEC 60794-1-2

Ordering information

12-.../EW(ZN)Z-...60	A-BQ(ZN)11Y - 1 x u/125
----------------------	-------------------------

Optiflex

Specification			
Jacket Ø	mm	6.0	
No. of fibers		2 to 12	
Loose tube		Flex	
Approx. weight	kg/km	26	
Fiber type		E9 , G50	

Mechanical properties				
Tensile strength	during installation	N	4000	IEC 60794-1-21 E1
	in service	N	2000	
Min. bend radius	during installation	mm	60	IEC 60794-1-2 E11
	in service	mm	60	
Crush resistance	short-term	N/dm	10 000	IEC 60794-1-2 E3
	long-term	N/dm	2000	
Repeated bending	R=25mm, m=5kg	cycles	20 000	IEC 60794-1-21 E6
Flexing	R=120mm, m=1kg	cycles	100 000	IEC 60794-1-21 E8
Coiling capability	l=100m, R=80mm	cycles	100	HUBER+SUHNER
Impact resistance	Wp=2.2J	impacts	20	IEC 60794-1-21 E4
Torsion	±360°, l=1000mm	cycles	100 000	IEC 60794-1-21 E4

Thermal properties				
Temperature range	during installation	°C	-25 to +85	IEC 60794-1-22 F1
	in service	°C	-45 to +85	
	in storage	°C	-60 to +85	

Combustion properties			
Fire load	MJ/m	3.4	
2011/65/EC (RoHS)		compliant	

p = passed

Drag chain cables

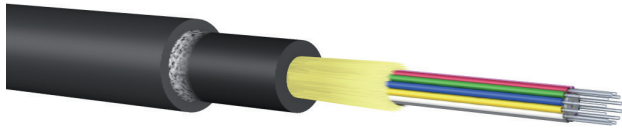

Properties

- Strain relieved with aramide yarn
- For direct connector assembly
- High chemical resistance against acids and alkalis
- For high mechanical and thermal stability
- Halogen free and non-corrosive fire gases
- Improved crush resistance
- Metal free

Applications

- Medium to large drag chains
- Cabling in industrial applications
- As control or data cable in industry robots, cranes, production lines and automation systems
- Cable design allows for a permanent load with more than one million drag chain cycles

Design

Cable design	up to 12 tight tubes strength member
Strain relief and rodent protection	aramide yarn
Jacket material	TPU (optional TPU flame retardant)
Jacket colour	black

According to IEC 60794-1-2

Ordering information

12-.../FSN(ZN)YZ-...130

12-.../FSN(ZN)YU-...130 (Flame retardant outer jacket)

Drag chain cables

Specification				
Fiber types	mm	E9	G50, G62.5	
Jacket Ø	mm	13	13	
Tube Ø	mm	0.9	0.9	coloured
Approx. weight	kg/km	128	128	

Mechanical properties					
Tensile strength	during installation	N	4000	4000	IEC 60794-1-2 E1
	in service	N	2000	2000	
Min. bend radius	during installation	mm	200	200	IEC 60794-1-2 E11
	in service	mm	100	100	
Crush resistance	short-term	N/dm	4000	4000	IEC 60794-1-2 E3
	long-term	N/dm	2000	2000	
Repeated bending	r = 100 mm, weight = 5 kg	cycles	5000	5000	IEC 60794-1-2 E6
Flexing	r = 120 mm velocity = 0.5 m/s, L = 2.0 m	cycles	100 000	100 000	IEC 60794-1-2 E8
Flexing	r = 100 mm velocity = 2 m/s, L = 2.0 m	cycles	1 000 000	1 000 000	HUBER+SUHNER drag chain test

Thermal properties					
Temperature range	during installation	°C	-10 to +50	-10 to +50	IEC 60794-1-22 F1
	in service	°C	-40 to +85	-30 to +85	
	in storage	°C	-40 to +85	-40 to +85	

Combustion properties				
Fire load		MJ/m	3,49	
Fire propagation	on a vertical single cable		p*	IEC 60332-1-2
2011/65/EC (RoHS)			compliant	

p = passed

* only with TPU flame retardant outer jacket

RADOX® Drag chain cable

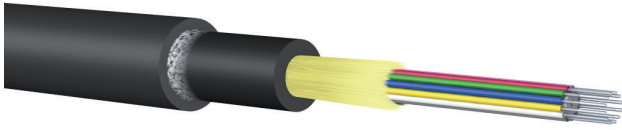

Properties

- Strain relieved with aramide yarn
- For direct connector assembly
- High chemical resistance against acids and alkalies
- For high mechanical and thermal stability
- Halogen free and non-corrosive fire gases
- Improved crush resistance
- Metal free
- Weld bead resistant cable outer jacket

Applications

- Medium to large drag chains
- Cabling in industrial applications
- As control or data cable in industry robots, cranes, production lines and automation systems
- Cable design allows for a permanent load with more than one million drag chain cycles

Design

Cable design	up to 12 tight tubes strength member
Strain relief and rodent protection	aramide yarn
Jacket material	RADOX®
Jacket colour	black

According to IEC 60794-1-2

Ordering information

12-.../FSN(ZN)YR-...130

RADOX® Drag chain cable

Specification			
Fiber types	mm	E9.G50	
Jacket Ø	mm	13	
Tube Ø	mm	0.9	coloured
Approx. weight	kg/km	160	

Mechanical properties				
Tensile strength	during installation	N	4000	IEC 60794-1-2 E1
	in service	N	2000	
Min. bend radius	during installation	mm	200	IEC 60794-1-2 E11
	in service	mm	100	
Crush resistance	short-term	N/dm	15 000	IEC 60794-1-2 E3
	long-term	N/dm	5000	
Repeated bending	r = 100 mm, weight = 5 kg	cycles	5000	IEC 60794-1-2 E6
Flexing	r = 120 mm velocity = 0.5 m/s, L = 2.0 m	cycles	25 000	IEC 60794-1-2 E8

Thermal properties				
Temperature range	during installation	°C	-10 to +50	IEC 60794-1-22 F1
	in service	°C	-30 to +85	
	in storage	°C	-40 to +85	

Combustion properties				
Fire load		MJ/m	4.6	
Fire propagation	on a vertical single cable		p	IEC 60332-1-2
2011/65/EC (RoHS)			compliant	

p = passed

Industry Link RADOX® TWINFIX – glass-armoured breakout cables



Properties

- Metal free indoor and outdoor cable
- For direct connector assembly with strain relief
- Rodent-protected, glass-armoured
- Easy stripping
- Low smoke, halogen free and self-extinguishing
- Improved crush resistance
- For high thermal and mechanical stability
- UV-protected, suitable for outdoor use
- Longitudinal and transversal watertight cable

Applications

- For fixed installation
- Industrial Ethernet and LAN
- Machine cabling
- As control or data cable in industrial plants
- Cabling in harsh environment conditions
- Connection to outdoor devices

Design

Cable design	2 single fiber cables with tight tubes
Strain relief	glass-armoured
Jacket material	RADOX®
Jacket colour	black

According to IEC 60794-1-2

Ordering information

02-.../(ZNG)R-...22

Industry Link RADOX® TWINFIX – glass-armoured breakout cables

Specification

Cable type		Industry Link TWINFIX		
Fiber types		E9 G50	H200	
Jacket Ø	mm	7.5 7.2	7.5 × 7.2	
Single fiber cable Ø	mm	2.2	2.2	
Tube Ø	mm	0.9	0.9	
Channel marking on single fiber		black and orange with arrows		
Approx. weight	kg/km	68	68	

Mechanical properties

Tensile strength	during installation	N	4000	4000	IEC 60794-1-2 E1
	in service	N	2 × 100	2 × 100	
Min. bend radius	during installation	mm	40	70	IEC 60794-1-2 E11
	in service	mm	25	40	
Crush resistance	short-term	N/dm	12000	6000	IEC 60794-1-2 E3
	long-term	N/dm	2000	2000	
Impact resistance	Wp = 2.2 J	impacts	50	200	IEC 60794-1-2 E4
Repeated bending	r = 60 mm/1 kg	cycles	10 000	10 000	IEC 60794-1-2 E6
Torsion	± 360°	cycles	15000	15000	IEC 60794-1-2 E7
Water penetration	h = 1 m, 24 d, p < 3 m		p	p	IEC 60794-1-2 F5A

Thermal properties

Temperature range	during installation	°C	-20 to +70	-20 to +70	IEC 60794-1-22 F1
	in service	°C	-45 to +75	-50 to +75	
	in storage	°C	-45 to +75	-50 to +75	

Combustion properties

Fire load		MJ/m	0.8	0.8	
Fire propagation	on a vertical cable bundle		b	b	IEC 60332-3-25
Halogen acid gas	jacket material		b	b	IEC 60754-1
Degree of acidity	jacket material		b	b	IEC 60754-2
2011/65/EC (RoHS)			compliant		

p = passed

DNV GL Type approved multi fiber loose tube cables – steel – or glass armoured

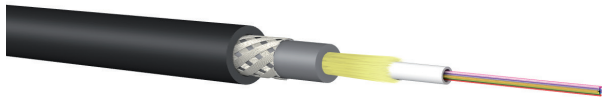

RADOX®

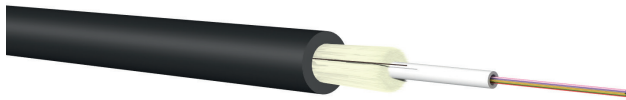

LSFH™

Properties

- Steel armoured inner and outer cable
- With rodent protection (steel armoured)
- For high mechanical and thermal requirements
- Low smoke, halogen free and self-extinguishing
- Low fire load for high safety requirements

Applications

- For outdoor and indoor installations and in mechanically unprotected environments
- Data cable in distribution networks
- For installations directly in the ground



Design

Cable design	multi fiber loose tubes up to 24 fibers, jelly-filled	
Strain relief	aramid yarn/glass-rovings	
Rodent protection	steel-armoured	glass-rovings
Jacket material	RADOX®	LSFH™
Jacket colour	black	

According to IEC 60794-1-2

Ordering information

24-.../W(ZN)HAR-...82 Certificate No. TAE 0000173
24-.../W(ZNG)H-...120 Certificate No. TAE 0000172

Approvals

- DNV GL Type approved
- Certificate no.:
TAE 0000173
TAE 0000172

DNV GL Type approved multi fiber loose tube cables – steel – or glass armoured

Specification		Steel armoured	Glas armoured	
Jacket-Ø	mm	8.2	12.0	
Number of fibers		2 – 24	2 – 24	
Multi fiber loose tube	mm	standard	standard	
Approx. weight	kg/km	115	178	

Mechanical properties					
Tensile strength	during installation	N	3750	9000	IEC 60794-1-2 E1
	in service	N	2000	4500	
Min. bending radius	during installation	mm	120	180	IEC 60794-1-2 E11
	in service	mm	80	120	
Crush resistance	5 min	N/dm	2000	6000	IEC 60794-1-2 E3
Cold bending radius	T= -25°C	mm		120	
Impact resistance	Wp = 5 J	impacts	1	1	IEC 60794-1-21 E4
Repeated bending	R=100 / weigth = 10kg	cycles		500	IEC 60794-1-21 E6
Torsion	± 180	cycles	20	20	IEC 60794-1-21 E7

Thermal properties					
Temperature range	during installation	°C	-20 to +70	-10 to +50	IEC 60794-1-22 F1
	in service	°C	-50 to +85	-40 to +70	
	in storage	°C	-50 to +85	-40 to +70	

Combustion properties					
Fire load		MJ/m	1.7	3.1	
Fire propagation	on a vertical single cable		b	b	IEC 60332-1-2
Fire propagation	on a vertical cable bundle		b	b	IEC 60332-3-24
Fire test	with circuit integrity (CI)	min.		180 180	IEC 60331-25 EN50200
Smoke density			b	b	IEC 61034-2
Halogen acid gas	jacket material		b	b	IEC 60754-1
Degree of acidity	jacket material		b	b	IEC 60754-2
Oil resistance	IRM902		168h; 100 °C	8h; 70 °C	IEC 60092-360
Drilling fluid resistance	IRM903		168h; 100 °C		IEC 60092-360
Drilling fluid resistance	CaBr2		56d; 70 °C		IEC60092-360
2011/65/EC (RoHS)			compliant		

p = passed

HVDC breakout cable 2.0 mm



Properties

- Metal-free indoor cable
- Low smoke, halogen free and self-extinguishing
- Aramide-free cable construction

Applications

- Installation in indoor areas
- Data cable in distribution centres
- For installation in cable ducts
- Ideal for applications involving high safety requirements in case of fire

Design

Cable design	central strength member, non metallic, 16 to 18 single-fiber cables with tight tube, separating tape
Channel marking	single-fiber cable numbered
Jacket material	LSFH™
Tube/jacket colour	black

According to IEC 60794-1-2

Ordering information

16-.../FSNH-...20
16-.../VSNH-...20
18-.../FSNH-...20
18-.../VSNH-...20

HVDC breakout cable 2.0 mm

Specification		16	16	18	18	
CPR main class	mm	12.0	12.0	13.0	13.0	
Single-fiber cable Ø	mm	2.0	2.0	2.0	2.0	
Tube Ø	mm	0.9	0.5	0.9	0.5	numbered
Approx. weight	kg/km	138	138	162	162	
Fiber type		E9, G50, G62	H200	E9, G50, G62	H200	

Mechanical properties							
Tensile strength	during installation	N	700	700	1000	1000	IEC 60794-1-2 E1
	in service	N	16 × 15	16 × 15	18 × 15	18 × 15	
Min. bend radius	during installation	mm	180	180	200	200	IEC 60794-1-2 E11
	in service	mm	120	120	160	160	
Crush resistance	short-term	N/dm	10 000	10 000	10 000	10 000	IEC 60794-1-2 E3
	long-term	N/dm	2000	2000	2000	2000	
Repeated bending	R=120mm, m=4.5kg	cycles	1000	1000			IEC 60794-1-21 E6
	R=150mm, m=2.0kg	cycles	1000				
Kink resistance	R=20mm		p	p			IEC 60794-1-21 E10
Flexing	R=240mm	cycles	100	100			IEC 60794-1-21 E8
Coiling capability	l=100m, R=120mm	cycles	5	5			HUBER+SUHNER
Impact resistance	Wp=1J, r=25mm	impacts	10	10	10	10	IEC 60794-1-21 E4
Torsion	±180°, l=1000mm, m=4kg	cycles	10	10			IEC 60794-1-21 E4

Thermal properties							
Temperature range	during installation	°C	-25 to +70				IEC 60794-1-22 F12
	in service	°C	-25 to +85				
	in storage	°C	-45 to +85				

Combustion properties							
Fire load		MJ/m	3.4	3.4	3.7	3.7	
Fire propagation	on a vertical single cable		p	p	p	p	IEC 60332-1-2
Halogen acid gas	Jacket material		p	p	p	p	IEC 60754-1
Degree of acidity	Jacket material		p	p	p	p	IEC 60754-2
2011/65/EC (RoHS)			compliant				

p = passed

Industry Link TWINFLEX and rugged minicord breakout cables



Rugged minicord breakout

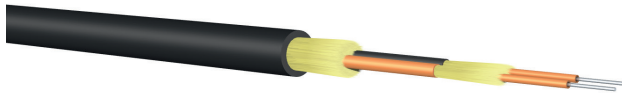

Industry Link TWINFLEX

Properties

- Metal free indoor and outdoor cable
- For direct connector assembly with strain relief
- Strain relieved with aramide yarn
- Ripcord for easy jacket removal
- Halogen free and non-corrosive fire gases
- Improved crush resistance
- For high thermal and mechanical stability
- High chemical resistance against acids and alkalies
- High abrasive resistance

Applications

- For flexible, moved and fixed use
- Industrial Ethernet and LAN
- Machine cabling, drag chains
- As control or data cable in factory automation
- Mobile data cabling for harsh environment
- Connection to outdoor devices

Design

Cable design	2 single fiber cables with tight tubes 1 ripcord
Strain relief	aramide yarn
Jacket material	TPU
Jacket colour	black

According to IEC 60794-1-2

Ordering information

Rugged minicord breakout	02-.../FJ(ZN)Z-...17
TWINFLEX	02-.../...(ZN)Z-...22

Conformance

TWINFLEX cables with H200 and POF meet PROFINET specification.

Industry Link TWINFLEX and rugged minicord breakout cables

Specification							
Cable type		rugged minicord breakout		Industry Link TWINFLEX			
Fiber types		E9, G50, G62	H200	G50, G62	H200	POF980	
Jacket Ø	mm	6.0		7.5 × 8.0			
Single fiber cable Ø	mm	1.7		2.2			
Tube Ø	mm	0.9	0.9	0.9	0.5	2.2	
Channel marking on single fiber		numbered		black and orange with arrows			
Approx. weight	kg/km	28		46			

Mechanical properties								
Tensile strength	during installation	N	2000	2000	2000	2000	2000	IEC 60794-1-2 E1
	in service	N	1000	500	1000	1000	1000	
Min. bend radius	during installation	mm	25	25	40	60	25	IEC 60794-1-2 E11
	in service	mm	25	25	25	50	25	
Crush resistance	short-term	N/dm	6000	2000	6000	6000	6000	IEC 60794-1-2 E3
	long-term	N/dm	2000	1000	2000	2000	4000	
Impact resistance	Wp = 1.5 J Wp = 2.2 J	im-pacts	200	200	200	200	200	IEC 60794-1-2 E4
Repeated bending	r = 30 mm/10 kg r = 60 mm/1 kg	cycles	20 000		10 000	10 000	10 000	IEC 60794-1-2 E6
Flexing	r = 77 mm	cycles	100 000					HUBER+SUHNER 1)
Flexing	r = 70 mm r = 80 mm				100 000	100 000	100 000	IEC 60794-1-2 E8 IEC 60794-1-2 E8
Torsion	± 360° ± 1440°	cycles	3		100	10	10	IEC 60794-1-2 E7

Thermal properties								
Temperature range	during installation	°C	-20 to +60			-10 to +60	-30 to +70	IEC 60794-1-22 F1
	in service	°C	-40 to +70			-20 to +70	-30 to +70	
	in storage	°C	-40 to +70			-25 to +70	-30 to +70	

Combustion properties							
Fire load	MJ/m	0.6	0.6	0.75	0.75	0.93	
2011/65/EC (RoHS)		compliant					

Conformance							
PROFINET	Specification 2)					yes	yes

Industry Link TWINFIX – glass-armoured breakout cables



Properties

- Metal free indoor and outdoor cable
- For direct connector assembly with strain relief
- Rodent-protected, glass-armoured
- Easy stripping
- Low smoke, halogen free and self-extinguishing
- Improved crush resistance
- For high thermal and mechanical stability
- UV protected, suitable for outdoor use
- Longitudinal and transversal watertight cable

Applications

- For fixed installation
- Industrial Ethernet and LAN
- Machine cabling
- As control or data cable in factory automation
- Data cabling for harsh environment
- Connection to outdoor devices
- LSFH™ – for applications involving high safety requirements in case of fire

Design

Cable design	2 single fiber cables with tight tubes
Strain relief	glass-armoured
Jacket material	LSFH™
Jacket colour	black

According to IEC 60794-1-2

Ordering information

02-.../(ZNG)H-...22

02-.../(ZNG)H-...22_UN (optional)

Approvals

UL listed acc. OFN/OFNG

Industry Link TWINFIX – glass-armoured breakout cables

Specification

Cable type		Industry Link TWINFIX			
Fiber types		E9, G50, G62	H200	POF980	
Jacket Ø	mm	7.5 × 7.2	7.5 × 7.2	7.5 × 7.2	
Single fiber cable Ø	mm	2.2	2.2		
Tube Ø	mm	0.9	0.9	2.2	
Channel marking on single fiber		black and orange with arrows			
Approx. weight	kg/km	61	67	67	

Mechanical properties

Tensile strength	during installation	N	2000	2000	2000	IEC 60794-1-2 E1
	in service	N	1000	1000	1000	
Min. bend radius	during installation	mm	40	105	25	IEC 60794-1-2 E11
	in service	mm	25	70	25	
Crush resistance	short-term	N/dm	6000	6000	5000	IEC 60794-1-2 E3
	long-term	N/dm	2000	2000	2000	
Impact resistance	Wp = 2.2 J	impacts	200	200	200	IEC 60794-1-2 E4
Repeated bending	r = 60 mm/1 kg	cycles	10 000	10 000	10 000	IEC 60794-1-2 E6
Torsion	± 360°	cycles	10	10	10	IEC 60794-1-2 E7
Water penetration	h = 1 m, 24 d, p < 3 m		p	p	p	IEC 60794-1-2 F5A

Thermal properties

Temperature range	during installation	°C	-10 to +60	-10 to +60	-10 to +60	IEC 60794-1-22 F1
	in service	°C	-40 to +70	-20 to +70	-30 to +70	
	in storage	°C	-45 to +70	-25 to +70	-30 to +70	

Combustion properties

Fire load		MJ/m	1.15	1.1	1.25	
Fire propagation	on a vertical cable bundle		p	p		IEC 60332-3-24
Fire test	with circuit integrity (CI)	min	90			IEC 60331-25
Halogen acid gas	jacket material		p	p	p	IEC 60754-1
Degree of acidity	jacket material		p	p	p	IEC 60754-2
2011/65/EC (RoHS)			compliant			

Conformance

PROFINET specification 1)			yes	yes	
(EU) No 305/2011 (CPR)		Dca-sla, d0, a1			EN 50575

p = passed

RADOX® glass-armoured multi-fiber loose tube cables

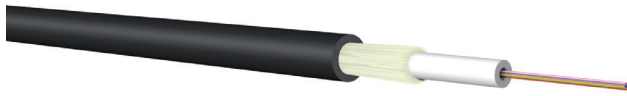

Properties

- Metal free rodent-protected indoor and outdoor cable
- High flexibility and form stability
- UV and ozone resistance
- High abrasion and soldering iron resistance
- Halogen free cable with improved behaviour in case of fire
- Meets requirements for circuit integrity in case of fire
- Best oil and fluid resistance

Applications

- Ideal for applications involving safety requirements in case of fire
- Rolling stock in railway
- Oil and gas platforms
- Ships
- Tunnels
- Underground train stations

Design

Cable design	multi-fiber loose tube up to 24 fibers, jelly-filled RADOX cable
Strain relief	glass-roving
Jacket material	RADOX®
Jacket colour	black

According to IEC 60794-1-2

Ordering information

24-.../W(ZNG)R-...85

RADOX[®] glass-armoured multi-fiber loose tube cables

Specification

Jacket Ø			8.5	
Number of fibers			2 to 24	
Approx. weight		kg/km	88	

Mechanical properties

Tensile strength	during installation	N	3000	IEC 60794-1-2 E1
	in service	N	1500	
Min. bend radius	during installation	mm	130	IEC 60794-1-2 E11
	in service	mm	80	
Crush resistance	short-term	N/dm	10 000	IEC 60794-1-2 E3
	long-term	N/dm	2500	
Impact resistance	Wp = 4,41 J	impacts	15	IEC 60794-1-2 E4
Water penetration	h = 1 m, 24 h, p < 3 m		p	IEC 60794-1-2 F5B

Thermal properties

Temperature range	during installation	°C	-10 to +50	IEC 60794-1-22 F1
	in service	°C	-60 to +85	
	in storage	°C	-60 to +85	

Combustion properties

Fire load		MJ/m	1	
Fire propagation	on a vertical single cable		p	IEC 60332-1-2
Fire propagation	on a vertical bundle cable		p	IEC 60332-3-25
Fire test	with circuit integrity (CI)	min.	180	IEC 60331-25
Smoke density			p	IEC 61034-2
Halogen acid gas	jacket material		p	IEC 60754-1
Degree of acidity	jacket material		p	IEC 60754-2
2011/65/EC (RoHS)			compliant	
(EU) No 305/2011 (CPR)			Cca-s1a, d0, a1	EN 50575

p = passed

RADOX[®]

- Meets LSFH properties.
- RADOX[®] jacket material compliant to EM 104 specification of EN 50264-1 for railway rolling stock application.
- Fully compliant to CEN/TS 45545-2 for fire safety in railway applications.
- Meets the increased requirements of SHF2 (SHF Mud) and fulfills flame, fire, oil and mud resistance acc. NEK 606.
- NEK 606 standard for offshore oil and gas, ship and marine applications.
- Application acc. NEK 606: outdoor cable for emergency systems – operational during fire.

Industry Link QUADFIX – glass-armoured breakout cables



Properties

- Metal free indoor and outdoor cable
- Rodent-protected, glass-armoured
- For direct connector assembly with strain relief
- Easy stripping
- UV-protected, suitable for outdoor use
- For high thermal and mechanical stability
- Low smoke, halogen free and self-extinguishing
- Improved crush resistance
- Longitudinal and transversal watertight cable

Applications

- For fixed installation
- Industrial Ethernet and LAN
- As control or data cable in industrial plants
- Cabling in harsh environment conditions
- LSFH™ – for applications involving high safety requirements in case of fire

Design

Cable design	4 single fiber cables with tight tubes
Strain relief	glass-armoured
Jacket material	LSFH™
Jacket colour	black

According to IEC 60794-1-2

Ordering information

04-.../FJSN(ZNG)H-...22

04-H200/VJSN(ZNG)H-...22

Approvals

UL listed acc. OFN/OFNG

Industry Link QUADFIX – glass-armoured breakout cables

Specification

Cable type		Industry Link QUADFIX		
Fiber types		E9, G50, G62	H200	
Jacket Ø	mm	9	9	
Single fiber cable Ø	mm	2.2	2.2	
Tube Ø	mm	0.9	0.5	
Approx. weight	kg/km	91	87	

Mechanical properties

Tensile strength	during installation	N	2000	2000	IEC 60794-1-2 E1
	in service	N	1000	1000	
Min. bend radius	during installation	mm	135	135	IEC 60794-1-2 E11
	in service	mm	90	90	
Crush resistance	short-term	N/dm	15 000	6000	IEC 60794-1-2 E3
	long-term	N/dm	4000	2000	
Impact resistance	Wp = 2.2 J	impact	200	200	IEC 60794-1-2 E4
Water penetration	h = 1 m, 24 h, p < 3 m		p	p	IEC 60794-1-2 F5A

Thermal properties

Temperature range	during installation	°C	-10 to +60	-10 to +60	IEC 60794-1-22 F1
	in service	°C	-40 to +70	-20 to +70	
	in storage	°C	-40 to +70	-25 to +70	

Combustion properties

Fire load		MJ/m	1.63	1.62	
Fire propagation	on a vertical cable bundle		p	p	IEC 60332-3-24
Fire test	with circuit integrity (CI)	min	180		IEC 60331-25
Halogen acid gas	jacket material		p	p	IEC 60754-1
Degree of acidity	jacket material		p	p	IEC 60754-2
2011/65/EC (RoHS)			compliant	compliant	
(EU) No 305/2011 (CPR)			Cca-s1a, d0, a1		EN 50575

p = passed

Steel armoured multifiber loose tube cable

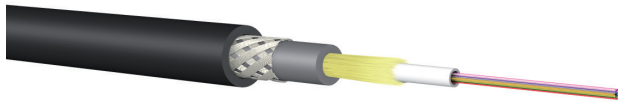

Properties

- Steel armoured indoor and outdoor cable
- With rodent protection (steel armoured)
- For high mechanical and thermal requirements
- Low smoke*, halogen-free and self-extinguishing
- Low fire load for high safety requirements

Applications

- For outdoor and indoor installations and in mechanically unprotected environments
- Data cable in distribution networks
- For in-ground installations

Design

Cable design	1 to 2 multifiber loose tube, jelly-filled (RADOX®, LSFH), jelly-free (TPU) up to 24 fibers		
Strain relief	aramid yarn		
Rodent protection	steel armoured		
Jacket material	RADOX®	LSFH	TPU
Jacket colour	black		

According to IEC 60794-1-2

Ordering information

24-.../W(ZN)HAR-...82 (RADOX®)	U-DQ(ZN)H(ZS)R 1 x .../125
24-.../W(ZN)HAH-...80 (LSFH)	U-DQ(ZN)H(ZS)H 1 x .../125
24-.../Q(ZNG)HAU-...80 (TPU)	U-BQ(ZN)H(ZS)11Y 1 x .../125

* Does not apply for TPU variant.

Steel armoured multifiber loose tube cable

Specification		RADOX	LSFH	TPU	
Jacket Ø	mm	8.2	8.0	8.0	
Number of Fiber		2 to 24	2 to 24	2 to 24	
Multifiber loose tube	mm	standard	standard	standard	
Approx. weight	kg/km	115	87	100	

Mechanical properties

Tensile strength	during installation	N	3750	3000	3000	IEC 60794-1-2 E1
	in service	N	2000	1500	1500	
Min. bend radius	during installation	mm	120	120	120	IEC 60794-1-2 E11
	in service	mm	80	80	80	
Crush resistance	short-term	N/dm	8000	4000	4000	IEC 60794-1-2 E3
	long-term	N/dm	2000	2000	2000	
Impact resistance	Wp = 4.5 J	impacts	50	50	50	IEC 60794-1-2 E4
Repeated bending	R=110 / weight = 2.5kg	cycles	10 000	5000		IEC 60794-1-21 E6
Kink resistance	Radius	mm	10	10		IEC 60794-1-21 E10
Torsion	± 180	cycles	70 000	500		IEC 60794-1-21 E7

Thermal properties

Temperature range	during installation	°C	-20 to +70	-20 to +70	-20 to +70	IEC 60794-1-22 F1
	in service	°C	-50 to +85	-40 to +85	-70 to +85	
	in storage	°C	-50 to +85	-40 to +85	-70 to +85	

Combustion properties

Fire load		MJ/m	1.25	1.5	1.1	
Fire propagation	on a vertical single cable		p	p	p	IEC 60332-1-2
Fire propagation	on a vertical cable bundle		p	p		IEC 60332-3-25
Fire propagation	on a vertical cable bundle			p		IEC 60332-3-22
Fire test	with circuit integrity (CI) min			180		IEC 60331-25
Smoke density			p	p		IEC 61034-2
Halogen acid gas	Jacket material		p	p		IEC 60754-1
Degree of acidity	Jacket material		p	p		IEC 60754-2
2011/65/EC (RoHS)			compliant	compliant	compliant	

p = passed

Rugged multifiber loose tube up to 24 fibers (jelly-free)



Properties

- Metal- and jelly-free cable
- Rodent-protected, glass-armoured
- For mobile applications
- No need for cleaning the fibers
- Longitudinal and transversal watertight cable

Applications

- Fixed or mobile data cabling
- Data cabling for harsh environment
- Machine cabling, drag chains

Design

Cable design	dry multifiber loose tube with 2 up to 24 fibers
Strain relief and rodent protection	glass-roving
Jacket material	TPU
Jacket colour	black

According to IEC 60794-1-2

Ordering information

24-.../Q(ZNG)Z-...70	A-BQ(ZN)B11Y 1 x .../125
----------------------	--------------------------

Rugged multifiber loose tube up to 24 fibers (jelly-free)

Specification			
Number of Fiber	mm	2 to 24	
Jacket Ø	mm	7.0	
Tube Ø	mm	2.8	coloured
Approx. weight	kg/km	44	

Mechanical properties				
Tensile strength	during installation	N	2500	IEC 60794-1-2 E1
	in service	N	1500	
Min. bend radius	during installation	mm	50	IEC 60794-1-2 E11
	in service	mm	70	
Crush resistance	short-term	N/dm	9000	IEC 60794-1-2 E3
	long-term	N/dm	2000	
Impact resistance	Wp = 1.5 J	impacts	100	IEC 60794-1-2 E4
Repeated bending	r = 50 mm, weight = 2 kg	cycles	10 000	IEC 60794-1-2 E6
Flexing	r = 120 mm velocity = 1.4 m/s	cycles	100 000	IEC 60794-1-2 E8
Water penetration	h = 1 m, 24 h, p < 3 m		b	IEC 60794-1-2 F5B

Thermal properties				
Temperature range	during installation	°C	-25 to +70	IEC 60794-1-22 F1
	in service	°C	-45 to +85	
	in storage	°C	-45 to +85	

Combustion properties			
Fire load	MJ/m	0.58	
2011/65/EC (RoHS)		compliant	

FO distribution boxes



Note: Find more technical details and options in the corresponding „Wireless Infrastructure“ and „FTTX solutions“ catalogue. Additional information is also available in the „Fiber optic enclosures and wall outlets“ catalogue.

[Go to external document/link ↗](#)

H3RO Box



[Go to external document/link ↗](#)

Features

- Robust IP68 rated for use in harsh environments
- Durable construction with static protection
- True plug and play functionality
- Compatibility with existing network infrastructure (SC, LC, ST connections)
- Significant cost reduction compared to traditional fibre installations
- Passive network system reducing active switching equipment
- High performance single mode fibre
- Reduced downtime due to the ease of installation
- Elimination of expensive, fault prone patch panels with BOTs and bulkheads
- Consolidation of spares, achieved with off the shelf consumable products
- Flexible mounting solutions including DIN, channel, fixed, cable, and mesh support

Technical data

Attribute	Values	Tested acc. to
Dimensions	155.3 × 120 × 97.5 mm	
Side load	150 N	
Ingress protection	IP68	
Impact resistance	IK 07	
Halogen free		IEC 60754-2
UV resistant for outdoor use		ISO 4892-3
Material flammability rating		UL94-V0
Vibration	10 Hz to 500 Hz/10 g	IEC 61300-2-1
Shock	50 g	IEC 61300-2-9

Environmental data

Characteristics	Values	Tested acc. to
Temperature range	-40°C up to +85°C	IEC 61300-2-22
Salt mist	96 h	IEC 61300-2-26

Ordering information

Description	Item no.
H3RO RING DISTR	85031882
H3RO NETWORK DISTR	85071425
H3RO FANOUT	85071426
H3RO RING ACCESS	85031883
H3RO TRUNK SPLITTER	85071427
H3RO TRUNK TERM	85071428
H3RO SPUR DIVIDER	85071429
H3RO DROP TAP 4	85071430
H3RO DROP TAP 2	85071431

MDR I module



Features

- Small dimension (W × H × D > 60 × 130 × 120 mm)
- Supports up to 24 fibers per module
- For SC-Simplex or LC-Duplex adapters
- Includes 2 splice cassettes for 12 F each
- Cable entries from top (2 × M18)
- Cable entries from bottom (2 × M18)
- Splice-patch and patch solution possible
- Bending radius protected
- Easy installation - snapped on a DIN-Rail

The MDR II module is a splice / patch module, which fits perfectly on a standard 35mm DIN-Rail. These modules are usually located in a wall box or in a street cabinet. In substations and other densely networked systems, robust fiber optic loose tube cables are used to connect switch cabinets. HUBER+SUHNER offers new, particularly compact modules (DIN rail modules) for connecting the cables to the active devices in the cabinets. The MDR II module is only 60 millimetres wide and is easily snapped on a DIN rail. It is usually positioned close to the active devices, such as process controls or switches, and has practical cable inputs and outputs.

The pigtailed are distributed to 12 adapters on the front. A maximum of 24 fibers can be connected using SFF connectors such as the LC. The MDR II module for applications in sub-stations, transformer stations, automation or traffic guidance systems is suitable for connecting field bus control lines, local area networks or control and measuring devices. It is available both for splice patch applications and for standard patching with pre-assembled cables and is small enough to allow the upgrading of existing cabinets.

Technical data

Description	Value
Dimensions (W x D x H)	60 × 130 × 120 mm
Capacity of optical connectors	12 SC shape
Mounting nature of adapters	snapped-in
Dimensions (Ø) of cable entry to break out	20 mm (M18)
Cable entries	2
Cables dimensions	5 mm to max. 10 mm
Material	steel generic, PC/ABS_PL
Color	RAL 7035, light grey
Minimum bending radius	30 mm

Ordering information

Description	Item no.
MDR II with sandwich spliceholder	85083911
MDR II with heatshrink spliceholder	85080628

MDR II module



Features

- Small dimension (W × H × D > 60 × 130 × 120mm)
- Supports up to 24 fibers per module
- For SC-Simplex or LC-Duplex adapters
- Includes 2 splice cassettes for 12 F each
- Cable entries from top (2 × M18)
- Cable entries from bottom (2 × M18)
- Splice-patch and patch solution possible
- Bending radius protected
- Easy installation – snapped on a DIN-Rail

Technical data

Description	Value
Dimensions (W × D × H)	60 × 130 × 120 mm
Capacity of optical connectors	12 SC shape
Mounting nature of adapters	snapped-in
Dimensions (Ø) of cable entry to break out	20 mm (M18)
Cable entries	2
Cables dimensions	5 mm to max. 10 mm
Material	steel generic, PC/ABS_PL
Colour	RAL 7035, light grey
Minimum bending radius	30 mm

Ordering information

Description	Item no.
MDR II with sandwich spliceholder	85083911
MDR II with heatshrink spliceholder	85080628

MONOLITH Box Medium



Features

- Supports up to 48 fibers per module
- Cable entry from the bottom and the top
- Splice and patch solution possible
- For SC simplex or LC duplex adapters
- Bending radius protected fiber overlength storage
- Can be easily snapped on a 35 mm DIN rail

Technical data

Characteristics	Value
Product family	FO-MONOLITH Box
Suitable for	splicing
Dimensions (W x D x H)	117 x 130 x 125 mm/ 4,6 x 5,1 x 4,9 inch
Weight	785 g (box only)/27.7 oz (box only)
Material box	steel with zinc plating
Colour module	RAL 7035
Minimum bending radius	25 mm
Number of Adaptor front	24 pcs
Adaptor type front	LC duplex, SC, E2000
Adaptor color front	blue = PC / UPC, green = APC, depending on connector type
Amount of base connector type (P1 / P2 / P3 / P4)	4
Connector type base	Q-ODC 12/ 24 socket or extension / none (gland)

Environmental data

Characteristics	Value
Temperature range (min to max)	-25 to +70 °C
Temperature resistance (min to max)	-13 to 158 °F
UL Rating	UL 94 V-0
Chemical resistance	Yes
UV resistance	Yes
Resistance to impact	IK08
Ingress protection degree	IP10
Free of halogen	Yes
RoHS compliant	Yes
REACH compliant	Yes

HDM Narrow



Features

- Robust metal construction
- Plug and play modules for fast deployment
- Capacity 24 ports and 2 QODC12/QODC24
- Fast and tool-less installation
- Available in all performance: single-mode and multimode
- Low insertion loss design
- Available with LC duplex, SC and E-2000TM
- Compact and robust
- Compatible with the fixed distribution panel
- Standard 90° QODC-socket
- Optional 22.5° or 45° angled socket

Technical data

Attribute	Value
Dimensions (W × D × H)	212 × 127 × 42 mm/8.35 × 5.0 × 1.65 in
Weight	0.8 kg
Material	aluminium powder coated
Colour	black (RAL 9005)
Number of adapters	ports: 24 (9.4 × 15.4 mm) SC-shape QODC: 2 straight/2 angled (25.4 × 25.4 mm)
Adapter types	LCD/SC/FLSH

Optical data

Attribute	Value
Fiber count	up to 24
Fiber type	single-mode 9/125 μm OS2 multimode
Q-ODC insertion loss (MT Elite)	SM OS2: typ. 0.15 dB, max. 0.35 dB MM: typ. 0.15 dB, max. 0.35 dB
Q-ODC return loss (MT Elite)	SM OS2 APC: ≥ 60 dB MM: ≥ 30 dB

Environmental data

Attribute	Value
Free of halogen	yes
2011/65/EC (RoHS)	fully compliant

Ordering information

Description	Item no.
Patching module 12 fiber, single size, single-mode QODC-12 to 12 FLSH APC 0.1dB, QODC angled 90°	85080300
Patching module 12 fiber, single size, multimode G62.5 QODC-12 to 12 FLSH, QODC angled 90°	85080301
Patching module 24 fiber, single size, single-mode 2xQODC-12 to 12 FLSH APC 0.1dB, QODC angled 90°	85080302
Patching module 24 fiber, single size, multimode G62.5 2xQODC-12 to 12 FLSH, QODC angled 90°	85080303
Patching module 24 fiber, single size, single-mode QODC-24 to 12 FLSH APC 0.1dB, QODC angled 90°	85080304
Patching module 24 fiber, single size, multimode G62.5 QODC-24 to 12 FLSH, QODC angled 90°	85080305

HDM Broad



Features

- Robust metal construction
- Capacity 12 or 18 ports
- Available in all performances: singlemode and multimode (OM3 and OM4)
- Produced with low-bend fiber
- Port identification front and top
- Available with LC-duplex, SC and E-2000™
- Up to 144 fibers per 1U HD panel
- Fast tool-less installation
- Compact and robust
- Factory tested „plug & play“ system
- Compatible with the HD zone distribution panel (ZDP) and zero space brackets

Highest density presentation for in-rack distribution

The MTP HD module is the highest density module currently available on the market. This compact unit acts as a termination point inside or close to equipment racks. MTP connectors on the rear side fan out to 12 or 18 LC-duplex, SC or E-2000™ adapters on the front side. This means that patch cords can be connected from the front of the module to equipment ports in the same or adjacent racks.

Technical data

Description	Value	
Dimensions (W × D × H)	212 × 127 × 21 mm/8.35 × 5.0 × 0.83 in	
Adapter types (front)	LC-duplex, SC, E-2000™	
Capacity	front of module	12 or 18 SC shaped adapters
	back of module	2 or 3 SC shaped MTP connectors
Material	aluminium powder coated	
Weight	approx. 300 g/10.58 oz	
Cables dimensions	5 mm to max. 10 mm	
Colour	black (RAL 9005)	
Free of halogen	yes	
2011/65/EC (RoHS)	fully compliant	

Ordering information

Description	Performance	Item no.
High density MTP module, black, 24 fiber 2 × MTP12 male, standard ferrule, 12 LC duplex ports, polarity A	SM	85014130
High density MTP module, black, 24 fiber 2 × MTP12 male, elite ferrule, 12 LC duplex ports, polarity A	SM	84150020
High density MTP module, black, 36 fiber 3 × MTP12 male, standard ferrule, 18 LC duplex ports, polarity A	SM	85014129
High density MTP module, black, 36 fiber 3 × MTP12 male, elite ferrule, 18 LC duplex ports, polarity A	SM	84148469
High density MTP module, black, 24 fiber 2 × MTP12 male, elite ferrule, 12 LC duplex port, polarity A	OM3	84150022
High density MTP module, black, 36 fiber 3 × MTP12 male, elite ferrule, 18 LC duplex ports, polarity A	OM3	84150024
High density MTP module, black, 24 fiber 2 × MTP12 male, elite ferrule, 12 LC duplex ports, polarity A	OM3	84150025
High density MTP module, black, 36 fiber 3 × MTP12 male, elite ferrule, 18 LC duplex ports, polarity A	OM3	84148468

MASTERLINE Flex Box



Key features

- Robust housing made of fiberglass reinforced polycarbonate
- Cost saving termination with split grommets while still IP56
- Wall, pole or cap rail mountable
- Up to two exchangeable fiber optic IANOS cassettes
- Up to 10 cables for diameter of 4.8 mm to 7 mm

Description of product

MASTERLINE Flex Box is a versatile distribution box simplifying outdoor deployment. It is designed for maximum planning flexibility for use in many street furniture and is simple to install with a guided inside layout and the IP protection around the fiber optic jumpers. And it has integrated cable overlength management for maximum comfort when doing maintenance or site upgrades. The MASTERLINE Flex Box is designed to stay in the network until 7G.

Applications

- Bus shelter
- Advertising pillar
- Campus

Technical data

Dimensions W × H × D (without DIN rail and animal proof bracket)	210 × 310 × 92 mm (for 1 IANOS cassette) 210 × 310 × 107 mm (for 2 IANOS cassettes)	
Weight	2.1 kg	
Box material	Fiberglass polycarbonate (housing, cover), stainless steel (bracket)	
Environmental data	Temperature range during installation	-10 °C up to +50 °C
	Temperature range in service	-40 °C up to +75 °C
	Ingress protection	IP66
	Impact resistance	IK 07
	Flammability class	UL94-V0
	UV resistance	1000 h (ISO 4892-2)
	Halogen-free	Yes (IEC 60754-2)

Ordering information

Description	Item no.
Masterline Flex Box for 1 IANOS module	85114792
Masterline Flex Box for 2 IANOS modules	85144638

Optibox 4i



Features

- Up to 4 adapters of SC shape
- Radius protected fiber management with a minimum bending radius of 28 mm
- Dedicated storage area for unused fibers
- Two different levels for managing up to 24 splices
- 1 cable entry and 2 cable exits (one at the top and one through the enclosure)
- Outside cable entries and exits are sealed with polymer cable glands
- Harsh environment protected ODC-2 (2 fibers) sockets mountable for creating „external“ connections
- Optional lock available
- Enclosure suitable for outdoor applications (IP67)
- Dedicated area to accommodate gas blockers if required

Technical data

Attribute		Value
Dimensions	W × D × H	150 × 250 × 46 mm
Capacity	detachable optical connections	8 × LC and LX.5, 4 × SC and E-2000™
	non detachable optical connections	24 × sandwich-, 12 × heat shrink splice protection
	dimension (∅) cable or blow-in conduits	3 – 12 mm
Material	enclosure (cover/base)	PC
	fiber inlay/extension tray/add-on lid	PC/ABS
	enclosure sealing	TPE, shore 50 A
	sealing grommets	TPE, shore 60 A
	lock (cylinder quarter turn lock)	GD-Zn chrome-plated
Weight	enclosure (cover/base)	381 gr. (188 gr./193 gr.)
	fiber inlay/extension tray/add-on lid	55 gr./36 gr./42 gr.
	sealing grommets	~ 4 gr.
	lock (cylinder quarter turn lock)	32 gr.
Color	enclosure (cover/base)	RAL 9016, traffic white
	fiber inlay/extension tray/add-on lid	RAL 9002, grey white
	sealing grommets	RAL 9005, jet black
	ingress protection degree (EN60529)	IP54
	resistance to impact (EN62262)	IK08
	temperature resistance short-term use	celsius: -46° to +120 °C fahrenheit: 50° to 250 °F
	temperature resistance long-term use	celsius: -46° to +120 °C fahrenheit: 50° to 178 °F
	insulation	fully insulated
	flamability rating enclosure (cover/base)	UL 94V-0
	fiber inlay/extension tray/add-on lid	UL 94V-0
	sealing grommets	UL 94V-0
UV resistance	enclosure (cover/base)	resistant
	fiber inlay/extension tray/add-on lid	limited resistant
	sealing grommets	resistant
	free of halogen	yes
	chemical resistance	good
	RoHS requirements	fully comply

Ordering information

Description	Item no.
Optibox 4i empty	84076039

Outdoor distribution box – small

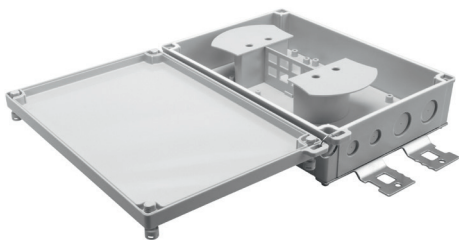

Features

- Ruggedised outdoor fiber-to-the-antenna (FTTA) distribution box
- Up to 8 adapters of SC shape
- Fitted with bend radius limiting mandrels
- 4 knock-out holes for flexible cable entry
- Suitable for mounting on poles, walls and tower legs with round-, L-, V- and O-shape
- Easy to mount and install with pre-mounted brackets
- Electrically isolated
- Fitted with protective vent to equalise pressure and to prevent water condensation

Technical data

Description	Value
Dimensions (W × D × H)	180 × 255 × 65 mm
Max. adapter capacity	8 adapters with SC shape
Ingress protection	IP67
Material	glass-filled polycarbonate
Color	RAL 7035 light grey
Knock-out holes	2 × Ø 16.4 mm, 2 × Ø 25.5 mm
Protective vent	IP67, typical airflow 2500 ml/min
Operating temperature	-40 to +85 °C
Resistance to impact (EN62262)	IK07
Flammability rating	UL 94V-0
Free of halogen	yes
RoHS compliance	fully compliant

Ordering information

Description	Item no.
Outdoor fiber distribution box - small	84074085

Outdoor distribution box – medium

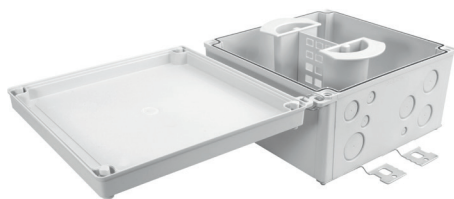

Features

- Ruggedised outdoor fiber-to-the-antenna (FTTA) box
- Up to 18 adapters of SC shape
- Fitted with bend radius limiting mandrels
- 15 knock-out holes for flexible cable entry
- Suitable for mounting on poles, walls and tower legs with round-, L-, V- and O-shape
- Easy to mount and install with pre-mounted brackets
- Electrically isolated
- Fitted with protective vent to equalise pressure and to prevent water condensation

Technical data

Description	Value
Dimensions (W × D × H)	240 × 240 × 132 mm
Max. adapter capacity	18 adapters with SC shape
Ingress protection	IP67
Material	glass-filled polycarbonate
Color	RAL 7035 light grey
Knock-out holes side A	2 × Ø 16.4 mm, 1 × Ø 26.5 mm, 3 × Ø 32.5 mm, 1 × Ø 37.5 mm
Knock-out holes side B	2 × Ø 20.5 mm, 4 × Ø 25.4 mm, 2 × Ø 32.5 mm
Protective vent	IP67, typical airflow 2500 ml/min
Operating temperature	-40 to +85 °C
Resistance to impact (EN62262)	IK07
Flammability rating	UL 94V-0
Free of halogen	yes
RoHS compliance	fully compliant

Ordering information

Description	Item no.
Outdoor fiber distribution box - medium	85015523

Outdoor distribution box – large

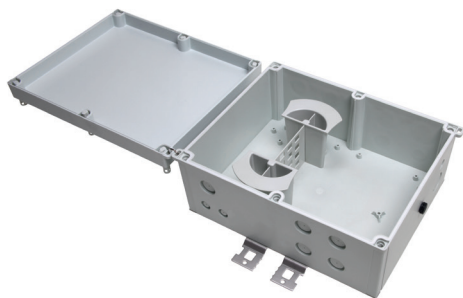

Features

- Ruggedised outdoor fiber-to-the-antenna (FTTA) distribution box
- Up to 24 adapters of SC shape
- Fitted with bend radius limiting mandrels
- 16 knock-out holes for flexible cable entry
- Suitable for mounting on poles, walls and tower legs with round-, L-, V- and O-shape
- Easy to mount and install with pre-mounted brackets
- Electrically isolated
- Fitted with protective vent to equalise pressure and to prevent water condensation

Technical data

Description	Value
Dimensions (W × D × H)	320 × 250 × 138 mm
Max. adapter capacity	24 adapters with SC shape
Ingress protection	IP67
Material	glass-filled polycarbonate
Color	RAL 7035 light grey
Knock-out holes side A	2 × Ø 16.3 mm, 1 × Ø 26.3 mm, 4 × Ø 32.3 mm
Knock-out holes side B	1 × Ø 20.2 mm, 6 × Ø 25.2 mm, 1 × Ø 32.3 mm
Knock-out holes side C	1 × Ø 32.1 mm, 1 × Ø 16.1 mm
Protective vent	IP67, typical airflow 2500 ml/min
Operating temperature	-40 to +85 °C
Resistance to impact (EN62262)	IK07
Flammability rating	UL 94V-0
Free of halogen	yes
RoHS compliance	fully compliant

Ordering information

Description	Item no.
Outdoor fiber distribution box - large	85090814

Outdoor distribution box – extra large

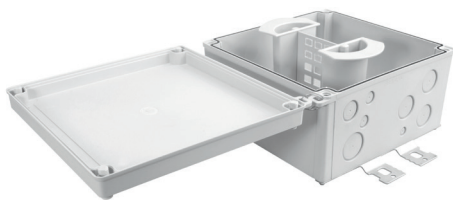

Features

- Ruggedised outdoor hybrid-to-the-antenna (HTTA) distribution box
- Up to 12 adapters of SC shape
- Fitted with bend radius limiting mandrels
- 32 knock-out holes for flexible cable entry
- Suitable for mounting on poles, walls and tower legs with round-, L-, V- and O-shape
- Easy to mount and install with pre-mounted brackets
- Electrically isolated
- Fitted with protective vent to equalise pressure and to prevent water condensation

Technical data

Description	Value
Dimensions (W × D × H)	429 × 390 × 159 mm
Max. adapter capacity	12 adapters with SC shape
Ingress protection	IP67
Material	glass-filled polycarbonate
Color	RAL 7035 light grey
Knock-out holes side A	1 × Ø 16.3 mm, 1 × Ø 20.4 mm, 6 × Ø 25.5 mm, 1 × Ø 26.5 mm 3 × Ø 32.5 mm, 1 × Ø 40.5 mm
Knock-out holes side B	6 × 3 pole power socket flange 6 × Q-ODC-2 socket flange 1 × Ø 16.3 mm, 1 × Ø 20.4 mm, 1 × Ø 40.5 mm
Knock-out holes side C	2 × Ø 12.0 mm, 1 × Ø 16.5 mm
Protective vent	IP67, typical airflow 2500 ml/min
Operating temperature	-40 to +85 °C
Resistance to impact (EN62262)	IK07
Flammability rating	UL 94V-0
Free of halogen	yes
RoHS compliance	fully compliant

Ordering information

Description	Item no.
Outdoor fiber distribution box - extra large	85028866

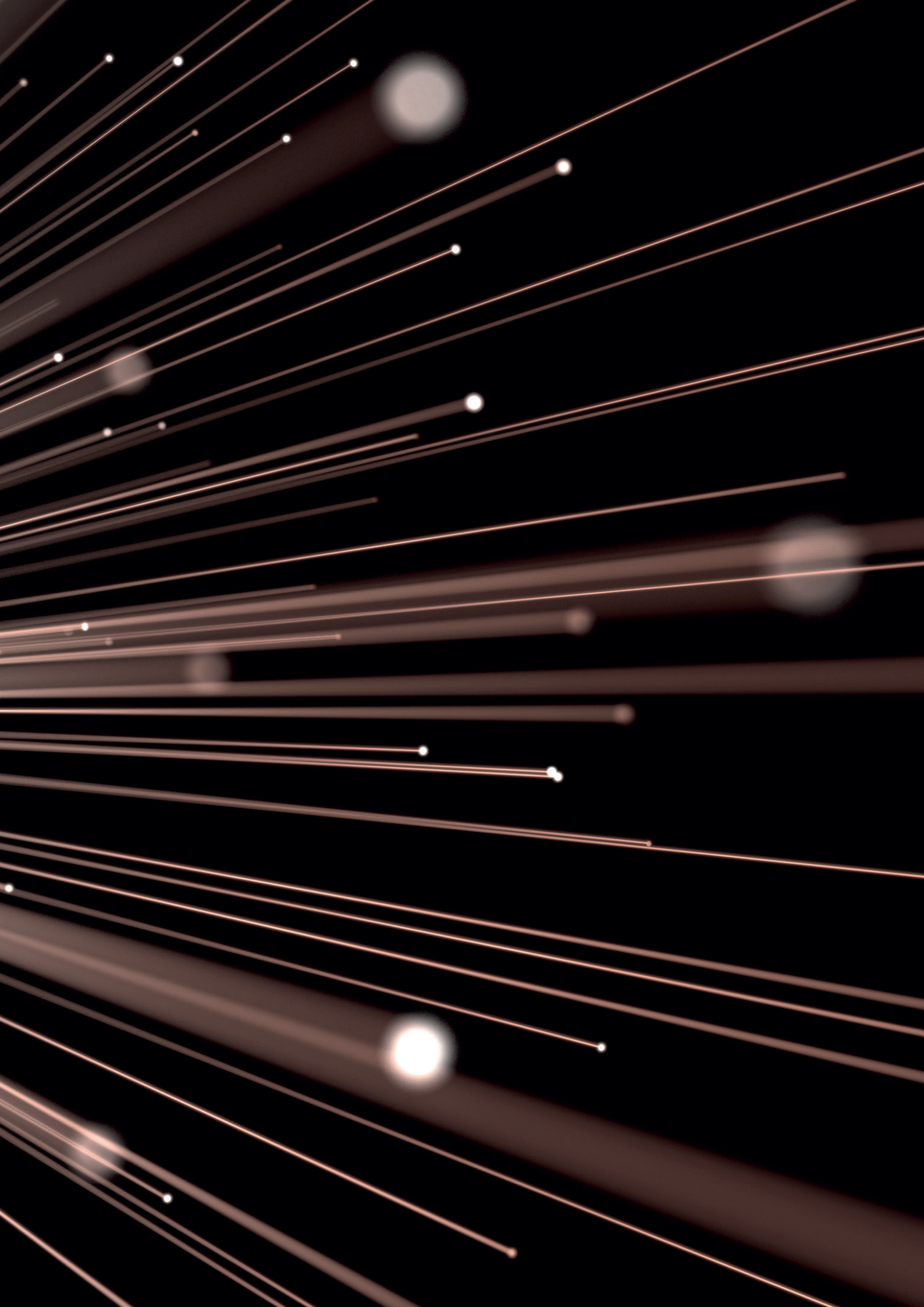

FO connectors



HUBER+SUHNER offers a broad selection of fiber optic connectors ranging from standard indoor to ruggedized outdoor connectors.

Fiber Optic connector

LSH (E-2000™) connector



Features

- Automatic metal shutter in connector and adaptor for dust protection and laser safety
- One-piece design for easy termination
- Colour coding of connector and adaptor
- Mechanical coding of connector and adaptor
- Ideal for high-power applications
- Switchable duplex clips

Specifications

Compliance	IEC 61754 - 15, TIA 604 - 16
Technology	full ceramic ferrule (2.5 mm) and sleeve
Tuning	in 60° steps
Operating temperature	-40 to +85 °C
Flammability	UL 94 V-0
Durability	min. 1000 mating cycles

ST connectors



Features

- Bayonet nut connector
- One-piece design
- ST security with integrated strain relief

Specifications

Compliance	IEC 61754-2, TIA 604-2
Technology	full ceramic ferrule (2.5 mm)
Strain relief	100 N
Operating temperature	-40 °C to +85 °C
Durability	min. 1000 mating cycles
Material	brass nickel plated

Fiber Optic connector

SC connector

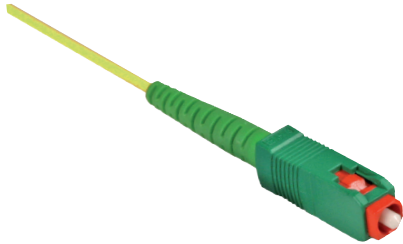

Features

- Push-pull connector
- One-piece design for easy and quick termination
- High mechanical and thermal resistance according to
- Telcordia GR-326-CORE

Specifications

Compliance	IEC 61754-4, TIA 604-3
Technology	full ceramic ferrule (2.5 mm) and sleeve (SM)
Tuning	in 45° steps
Mechanical resistance	100 N tensile load
Operating temperature	-40 to +85°C
Flammability	UL 94 V-0
Durability	min. 1000 mating cycles

LC-HQ push-pull (UPC) connector

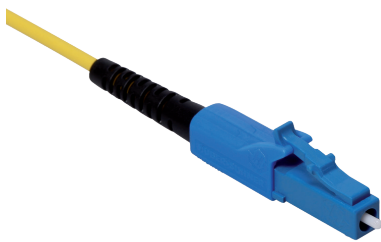

Features

- Push-pull mechanism for best handling and high packing density
- Patented (US 8.221.007)
- Two connections in one SC-shaped adaptor
- One-piece design for easy termination
- Short rigid length
- Switchable duplex connectors

Specifications

Compliance	IEC 61754-20, TIA 604-10-A
Technology	full ceramic ferrule (1.25 mm)
Tuning	in 45° steps
Operating temperature	-40 to +85 °C
Flammability	UL 94 V-0
Durability	min. 1000 mating cycles

XCO - ruggedized exchangeable SFP connector



Features

- 2 fibers, singlemode or multimode
- Standard LC duplex interface
- Ruggedized outdoor connector for fiber-to-the-antenna and industrial application
- Exchange and service of SFP module possible
- Easy manual installation – no tool required
- High installation safety due to reliable snap-in strain relief system (patented solution)
- Water proof protection cap with pulling eye
- EMI protected
- RoHs compliant

Specifications

Technology		LC with full ceramic ferrules
Housing materia		nickel-plated brass
Mating mechanism		patented snap-in strain relief system
Mechanical performance		≤ 500 N tensile load ≤ 30 N static side load
Operating temperature ¹⁾		-40 °C to +85 °C
Mating durability	IEC 61300-2-2	500 cycles
Ingress protection (mated)	IEC 60529	IP68
Salt mist	IEC 61300-2-26	30 days passed
Vibration	IEC 61300-2-1	passed 10 Hz – 500 Hz / 10 g
Shock	IEC 61300-2-9	passed 50 g

¹⁾ depending on cable type

Optical performance

Insertion loss	singlemode	typ. ≤ 0.20 dB	97% ≤ 0.45 dB
	multimode	typ. ≤ 0.20 dB	97% ≤ 0.50 dB
Return loss	singlemode	≥ 50 dB	passed 50 g

Mating sequences



Remove protection cap and slide back connector housing



Snap connector into flange – full strain relief



Remove LC dust caps and plug LC duplex connectors into SFP module



Screw-on housing to seal connector

XCO - ruggedized exchangeable SFP connector

Type X1: XCO connector plug

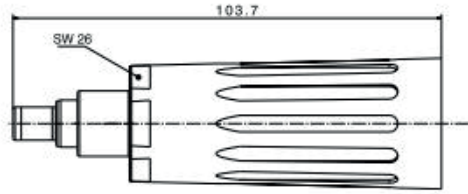

3D view

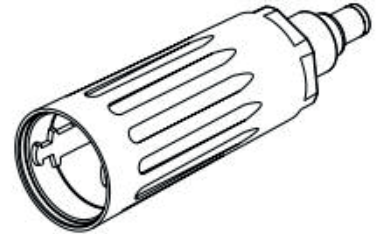



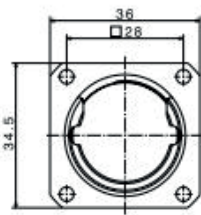

Type: XCO build-in flange

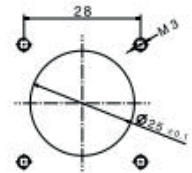

hole pattern



Mating mechanism

Description	Connector	Dust cap
X1	XCO connector 	IP68 
Item number 84074439	XCO build-in flange 	IP68 

Positioning dimensions of SFP module

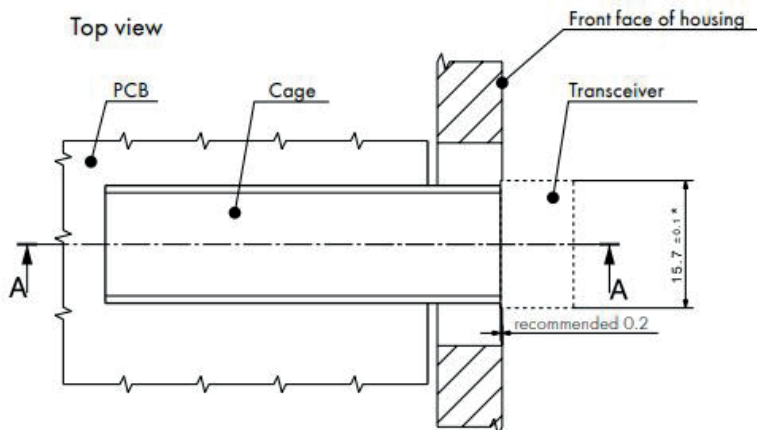

Lateral mounting tolerance between SFP module and XCO flange = ± 0.5 mm

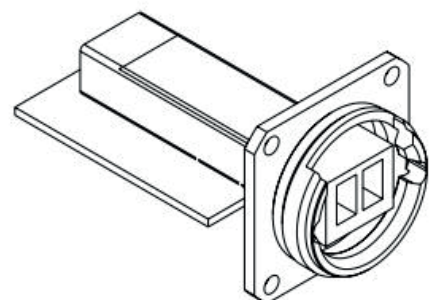

Q-XCO

Q-XCO – quick-lock ruggedised SFP connector



Features

- Quick-lock mating connector for remote radio head and industrial applications
- Ruggedised outdoor design with 2 × LC interface
- Plugs directly into SFP module, compatible with all standard SFP modules
- Full compensation of positioning tolerances and SFP module tolerances
- Bayonet, blind-mating mechanism and highest installation safety
- Full protection of optical interface during installation
- Access and exchange of SFP module possible
- RoHs compliant

Mating mechanism

Mating	1-step blind mating	bayonet
	mating references	visual and latch
Compensation of positioning tolerances of SFP module	z-axis	± 2.25 mm
	x, y-axis	± 0.4 mm (± 0.6 mm depending on SFP module)
Latching of LC connector	use of LC HQ technology	automating latching and unlatching
Mating durability	IEC 61300-2-2	100 cycles
Force on SFP module		no force in mated state

Specifications

Technology		LC full ceramic ferrules	
Housing material	connector	high-performance plastic	
	socket	die-casting with zinc plating	
Material flammability rating		UL 94-V0	
Mechanical performance	IEC 61300-2-4	≤ 400 N tensile load	
	IEC 61300-2-42	≤ 30 N static side load	
	IEC 61300-2-5	180° cable torsion, passed	
Thermal performance	operation, IEC 61300-2-22	-40 to +85 °C	
	installation	-40 to +55 °C	
Ingress protection	IEC 60529-20	IP67 (mated or with dust cap)	
Salt mist	84108683 85006151	IEC 61300-2-26, MIL-STD-202G method 101E IEC 61300-2-26	192 h 720 h
Vibration	IEC 61300-2-1, MIL-STD-202G, method 204G		passed 10 to 500 Hz/10 g
Shock	IEC 61300-3-3, MIL-STD-202G, method 213B		passed 50 g
UV resistance	ISO 4982-2		passed 2000 h at 2000 MJ/m2

Optical performance

Insertion loss	single-mode	typ. ≤ 0.20 dB	97 % ≤ 0.45 dB
	multi-mode	typ. ≤ 0.20 dB	97 % ≤ 0.50 dB
Return loss	single-mode	≥ 50 dB	

Q-XCO



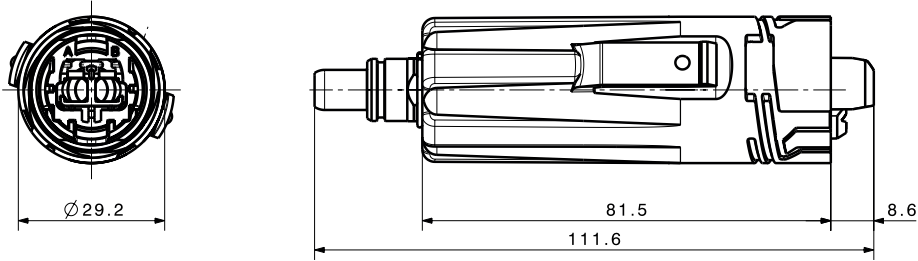

Q-XCO – quick-lock ruggedised SFP connector

Q-XCO plug

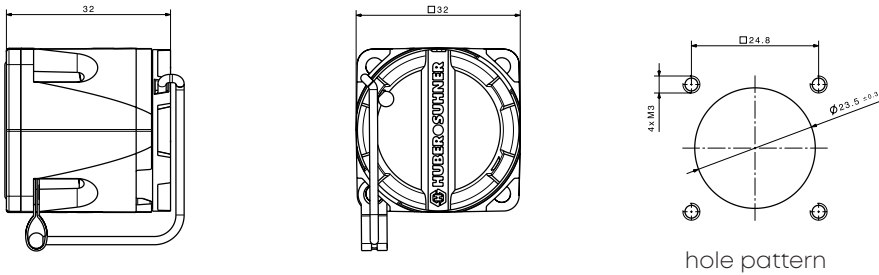

Q-XCO flange small



Type old	Type new	Picture		Dust cap	IP
XA	QXP2	Q-XCO connector			IP67
Item no. 84108683		Q-XCO flange small			IP67
Item no. 85006151		Q-XCO flange small e-coating			IP67

Q-XCO

Q-XCO – quick-lock ruggedised SFP connector

Installation safety for LTE and microwave links

Q-XCO is the most installation safe fiber optic interface on the market. The connector is designed for harsh outdoor applications and for installation in challenging environments such as high up on radio masts under any atmospheric condition.

Its „one-hand“ blind mating performance in combination with full SFP tolerance compensation makes this connector the best in its class. For that reason, leading system vendors have chosen Q-XCO as the fiber optic interface for LTE remote radios and for state-of-the-art microwave backhaul systems – simply to have better connections.

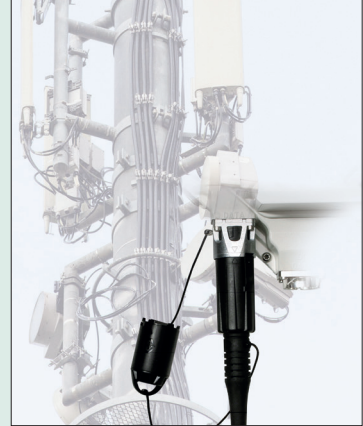

Tolerance compensation

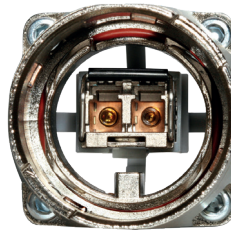

The connector compensates for all tolerances of SFP modules and for mounting tolerances



Exchange of SFP module
Release and pull SFP module

Mating sequences



Rotate to find correct keying position



Slide connector into flange and rotate 155° until snap-in position



Connector mated with visual reference for correct installation

Q-XCO

Q-XCO – quick-lock ruggedised SFP connector

SFP cage positioning specification

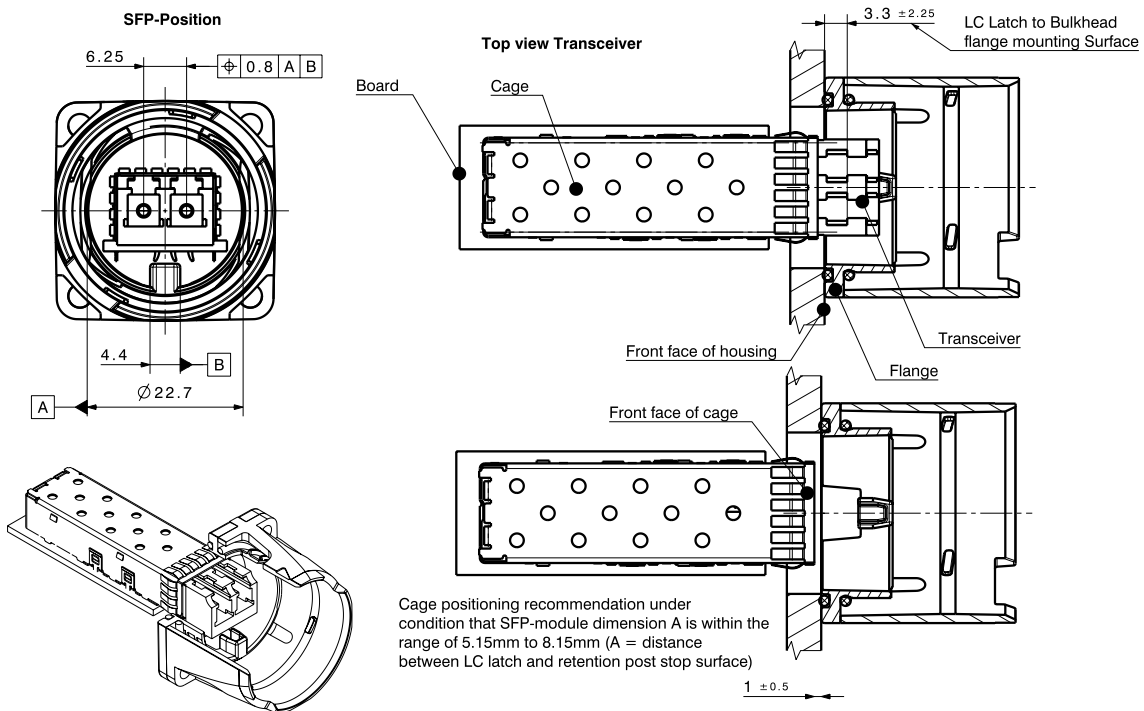

Module width and height extending outside of cage, see SFF-8432 Specification for Improved Pluggable Formfactor Rev. 5.0, July 16, 2007

Exclusion zone for connector mating

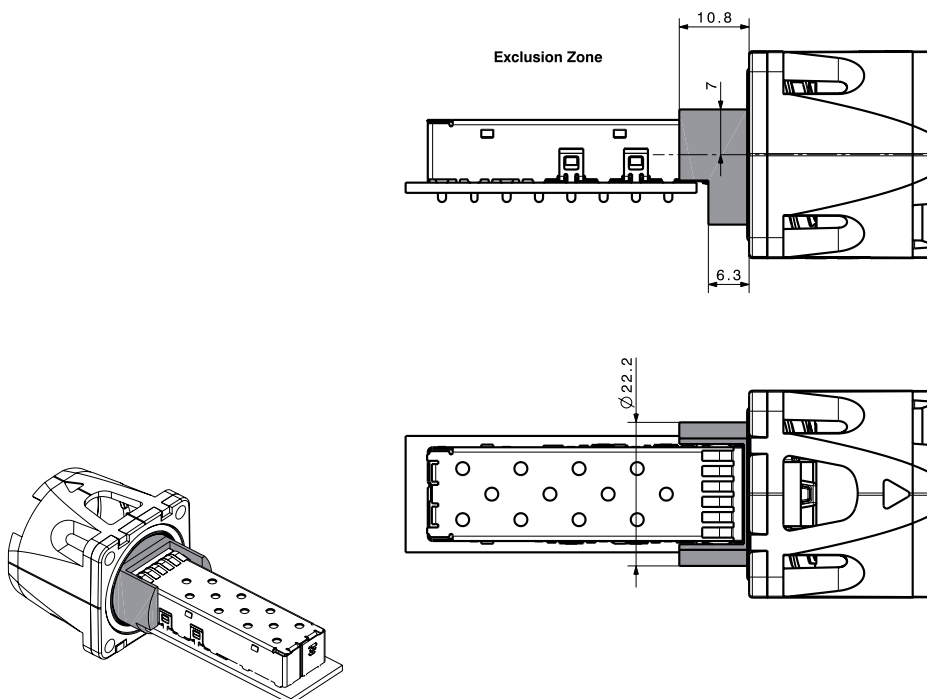

ODC-2



Features

- 2 fibers, single-mode or multimode
- Compact design with 2 × 1.25 mm ferrules
- Built-in socket with square or hexagonal flange
- Extension connector for cable chaining
- Screwed locking mechanism
- Easy and safe installation
- Waterproof, dust proof and corrosion resistant
- Waterproof protection caps
- EMI protected
- RoHs compliant
- Full compatibility with previous version
- Fulfills performance standard IEC 61753-1 Cat. E

Specifications

Technology		full ceramic ferrule and sleeve
Housing material		nickel-plated brass
Mechanical performance	ODC-2 plug	≤ 800 N tensile load ≤ 30 N static side load
Installation torque force	min. 1 Nm	max. 2 Nm
Operating temperature ¹⁾	IEC 61300-2-22	-40 up to +85 °C
Mating durability		1000 cycles ²⁾
Ingress protection (mated)	IEC 60529	IP 68
Salt mist	IEC 61300-2-26	30 days passed
Vibration	IEC 61300-2-1	passed 10 to 500 Hz/10 g
Shock	IEC 61300-2-9	passed 100 g

¹⁾ depending on cable type

²⁾ with repeated cleaning

MASTERLINE Mobile Extreme is available with outdoor connectors ODC-2, ODC-4, Q-ODC-2 and Q-ODC-12.

ODC-2

ODC-2 assemblies

Standard type ODP1, ODP2: ODC-2 plug

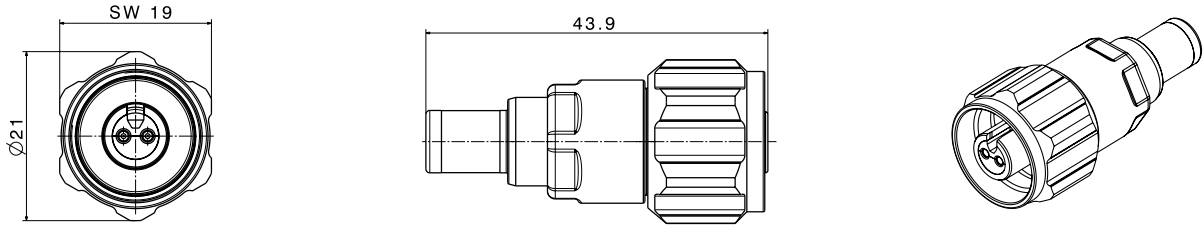

Standard type ODE1, ODE2: ODC-2 extension

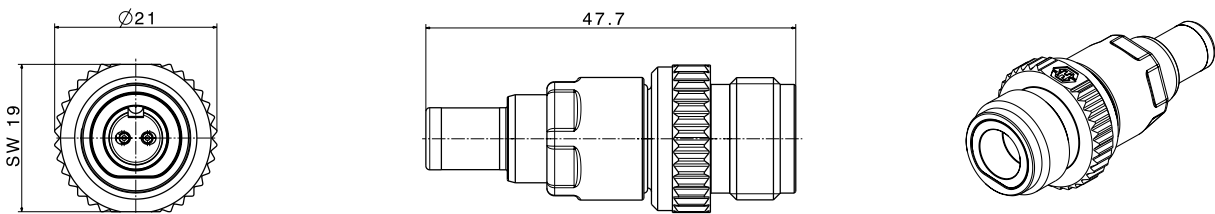

Standard type ODS1, ODS2: ODC-2 socket – square small

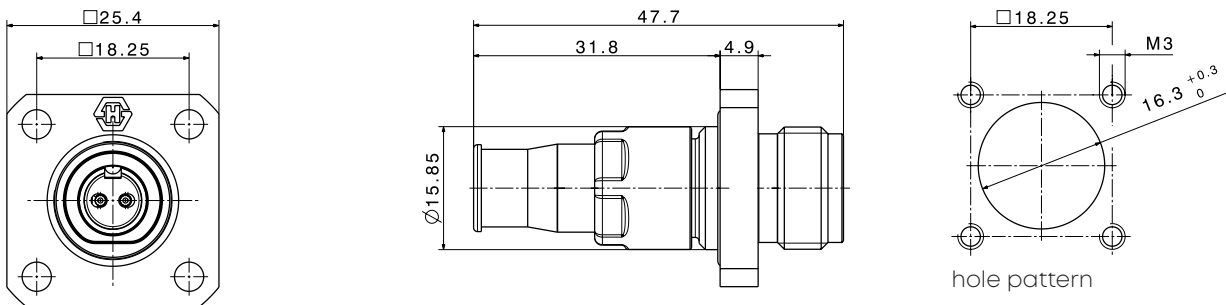

NON-standard type ODR1, ODR2: ODC-2 socket hexagonal, mounted from the rear

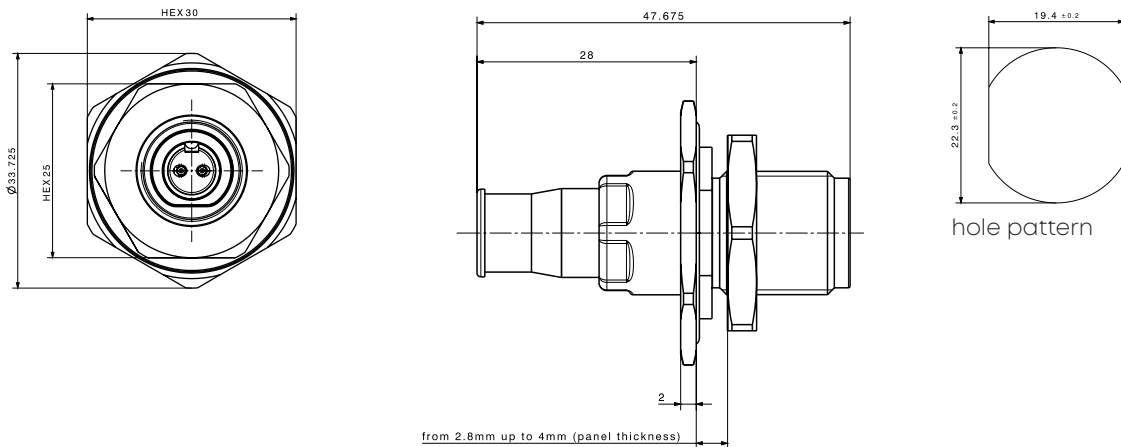

ODC-4



Features

- 4 fibers, single-mode or multimode
- Compact design with 4 × 1.25 mm ferrules
- Built-in socket with square or hexagonal flange
- Extension connector for cable chaining
- Screwed locking mechanism
- Easy and safe installation
- Waterproof, dust proof and corrosion resistant
- Waterproof protection caps
- EMI protected
- RoHs compliant
- Full compatibility with previous version
- Fulfills performance standard IEC 61753-1 Cat. E

Specifications

Technology		full ceramic ferrule and sleeve
Housing material		nickel-plated brass
Mechanical performance	ODC-4 plug	≤ 800 N tensile load ≤ 30 N static side load
Installation torque force	min. 1 Nm	max. 2 Nm
Operating temperature ¹⁾	IEC 61300-2-22	-40 up to +85 °C
Mating durability		1000 cycles ²⁾
Ingress protection (mated)	IEC 60529	IP68
Salt mist	IEC 61300-2-26	30 days passed
Vibration	IEC 61300-2-1	passed 10 to 500 Hz/10 g
Shock	IEC 61300-2-9	passed 100 g

¹⁾ depending on cable type

²⁾ with repeated cleaning

ODC-4

ODC®-4 assemblies

Type ODP1, ODP2: ODC-4 plug

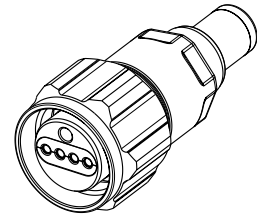
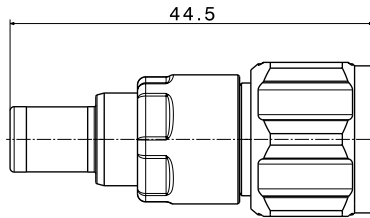
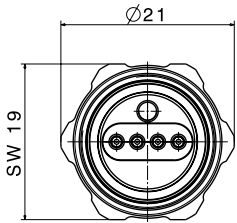

Type ODE1, ODE2: ODC-4 extension

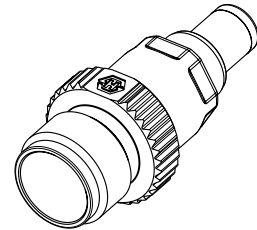
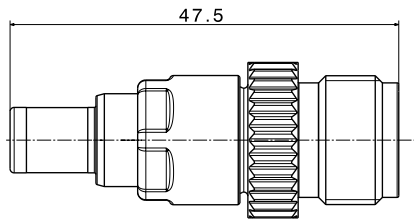
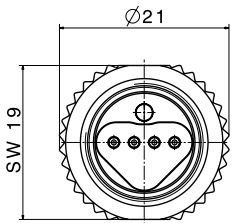

Standard type ODR1, ODR2: ODC-4 socket – hexagonal

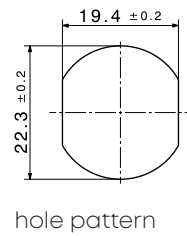
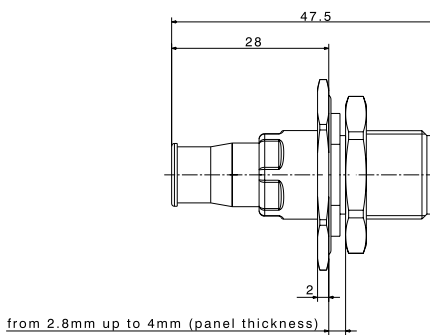
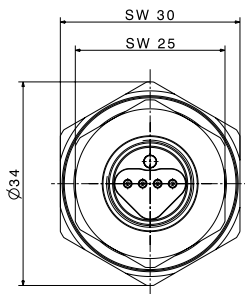

hole pattern

Standard type ODS1, ODS2: ODC-4 socket – square small

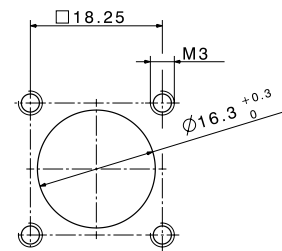
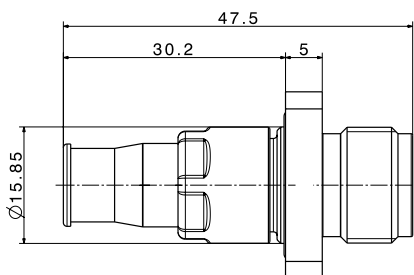
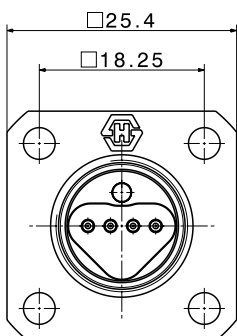

hole pattern

Q-ODC-2 Mini – smallest fiber optic connector for harsh environments

Fiber optic products manufactured by HUBER+SUHNER are suitable for complex applications with very high data rates and are constantly being further developed. HUBER+SUHNER is now expanding the connector portfolio with the Q-ODC-2 Mini. The size optimised connector with two fibers is used in especially harsh environmental conditions. Even when installation has to be fast and safe, this smallest fiber optic interface is the ideal solution for applications in communication and industrial market.

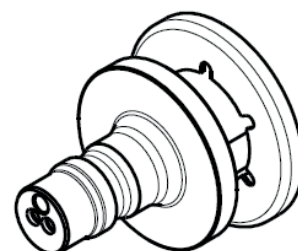
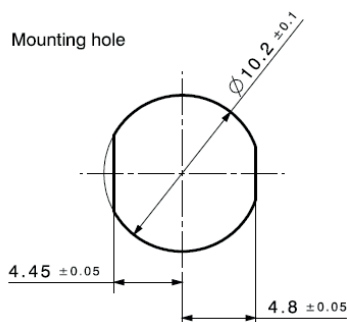
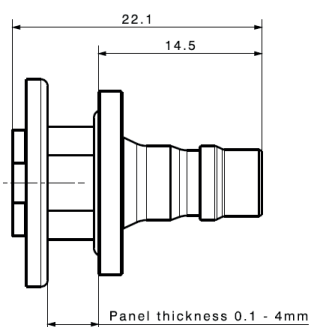
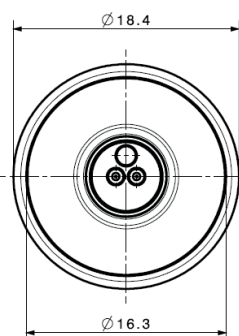
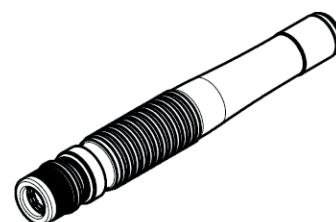
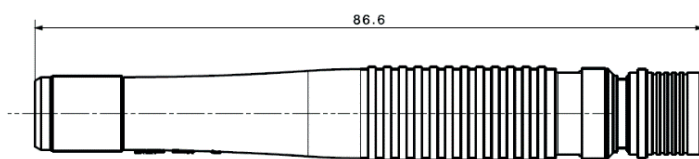
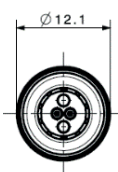

Q-ODC-2 Mini



Features

- 2 fibers, single-mode or multimode
- Compact design with 2 × 1.25 mm ferrules
- Size optimised built-in socket
- Extension connector for cable chaining
- Robust push-pull coupling mechanism – two clearly defined mating states
- Highest outdoor installation safety
- Waterproof, dust proof and corrosion resistant
- Waterproof protection caps available
- EMI protected
- RoHs compliant

Specifications		
Technology		full ceramic ferrule and sleeve
Housing material		nickel-plated brass
Mating mechanism		push-pull with two clearly defined states
Mechanical performance	Q-ODC plug	≤ 150 N tensile load
	Q-ODC socket	≤ 30 N tensile load
Operating temperature ¹⁾	IEC 61300-2-22	-40 up to +85 °C
Mating durability	IEC 61300-2-2	50 cycles ²⁾
Ingress protection (mated)	IEC 60529	IP65
Salt mist	IEC 61300-2-26	30 days passed
Vibration	IEC 61300-2-1	passed 10 to 500 Hz/10 g
	IEC 61373	passed category 1A/B, 2, 3
Shock	IEC 61300-2-9	passed 50 g
	IEC 61373	passed category 1, 2

¹⁾ depending on cable type, ²⁾ with repeated cleaning

Optical performance			
Insertion loss/IEC 61300-3-34	single-mode	typ. ≤ 0.20 dB	97 % ≤ 0.45 dB
	multimode	typ. ≤ 0.20 dB	97 % ≤ 0.50 dB
Return loss	single-mode	≥ 50 dB	

Q-ODC-2

Q-ODC-2 outdoor connector for harsh environment



Features

- 2 fibers, single-mode or multimode
- Compact design with 2 × 1.25 mm ferrules
- Built-in socket with square flange
- Extension connector for cable chaining
- Robust push-pull coupling mechanism – two clearly defined mating states
- Highest outdoor installation safety
- Waterproof, dust proof and corrosion resistant
- Waterproof protection caps available
- EMI protected
- RoHs compliant
- Fulfills performance standard IEC 61753-1 Cat. E

Specifications

Technology		full ceramic ferrule and sleeve
Housing material		nickel-plated brass
Mating mechanism		push-pull with two clearly defined states
Mechanical performance	Q-ODC plug	≤ 450 N tensile load ≤ 30 N static side load
	Q-ODC socket	≤ 30 N tensile load
Operating temperature ¹⁾	IEC 61300-2-22	-40 up to +85 °C
Mating durability	IEC 61300-2-2	200 cycles ²⁾
Ingress protection (mated)	IEC 60529	IP67
Salt mist	IEC 61300-2-26	30 days passed
Vibration	IEC 61300-2-1 IEC 61373	passed 10 to 500 Hz/10 g passed category 1A/B, 2, 3
Shock	IEC 61300-2-9 IEC 61373	passed 50 g passed category 1, 2

1) depending on cable type

2) with repeated cleaning

Optical performance

Insertion loss/IEC 61300-3-34	single-mode	typ. ≤ 0.20 dB	97 % ≤ 0.45 dB
	multimode	typ. ≤ 0.20 dB	97 % ≤ 0.50 dB
Return loss	single-mode	≥ 50 dB	

Mating sequences



Push plug connector slightly into extension connector, rotate to find keying position, push connector to mate.



Mated – connector snaps in and is fully strain relieved.



Pull coupling ring to un-mate.

Q-ODC-2

Q-ODC-2 outdoor connector for harsh environment, plug/socket

Overview of connector types

Type	Type new	Connector		Dust cap		
QA	QOP1	Q-ODC plug		push-on	IP67	
	QOP2			push-on	IP67	
QC	QOP3			snap-on	IP67	
QB	QOP4			snap-on with chain	IP67	
QE	QOE1	Q-ODC extension		push-on	IP67	
	QOE2			push-on	IP67	
QF	QOE3			snap-on	IP67	
QG	QOE4			snap-on with chain	IP67	
QS	QOS1	Q-ODC socket square		push-on	IP67	
	QOS2			push-on	IP67	
QT	QOS3			snap-on	IP67	
QU	QOS4			snap-on with chain	IP67	
	QOR1	Q-ODC socket hexagonal, mounted from the rear, simplex cable		push-on	IP67	
QOR2	push-on			IP67		
QI	QOR3			snap-on	IP67	
QJ	QOR4			snap-on with chain	IP67	

Q-ODC-2

Q-ODC-2

Type QOP1, QOP2, QOP3, QOP4: Q-ODC plug

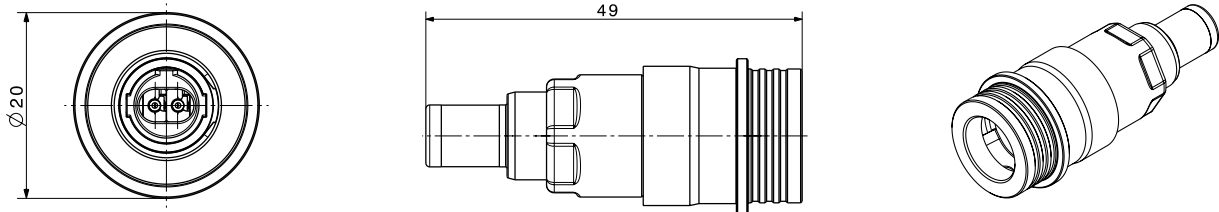

Type QOE1, QOE2, QOE3, QOE4: Q-ODC extension connector

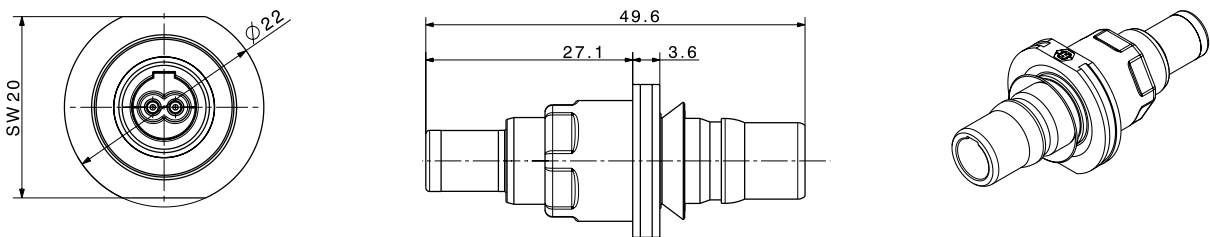

Type QOS1, QOS2, QOS3, QOS4: Q-ODC socket – square

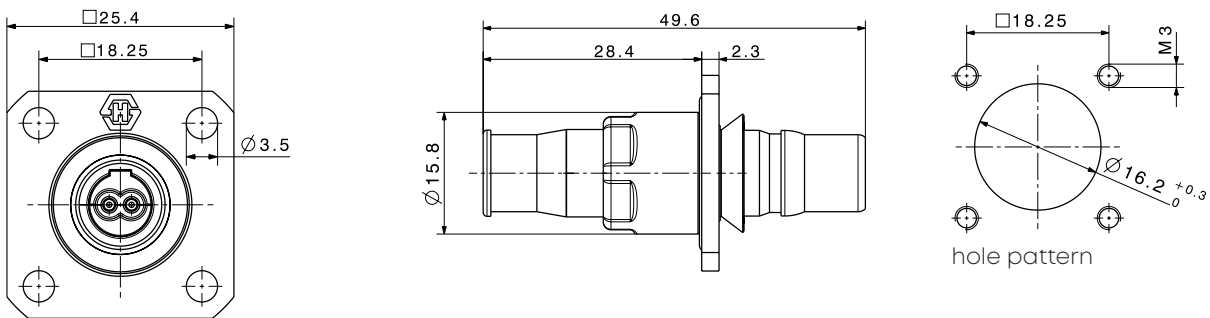

Type QOR1, QOR2, QOR3, QOR4: socket hexagonal

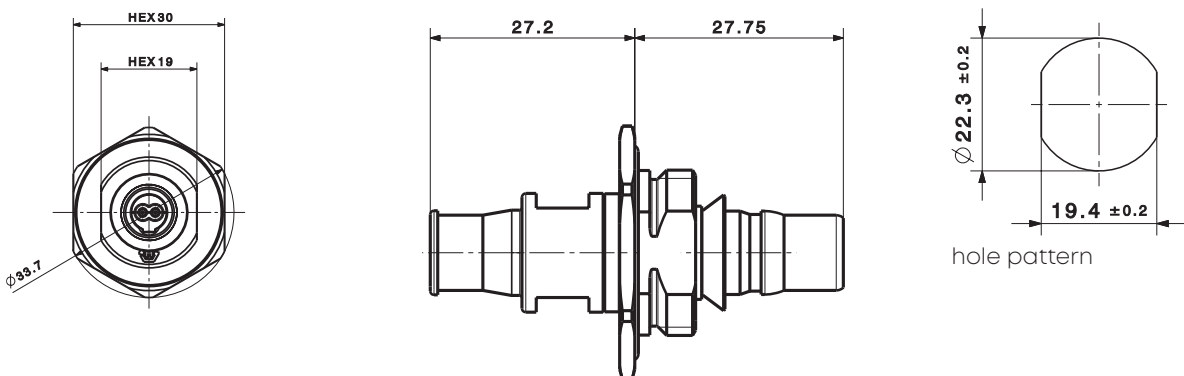

Q-ODC-2 Industry

Q-ODC-2 Industry outdoor connector



Features

- 2 fibers, singlemode or multimode
- Compact design with 2 x 1.25 mm ferrules
- Extension connector for cable chaining
- Robust push-pull coupling mechanism – two clearly defined mating states
- Highest outdoor installation safety
- Waterproof, dust proof and corrosion resistant
- Waterproof protection caps available
- EMI protected
- RoHs compliant
- Fulfills performance standard IEC 61753-1 Cat. E

Specifications

Technology		full ceramic ferrule and sleeve
Housing material		nickel-plated brass
Mating mechanism		push-pull with two clearly defined states
Mechanical performance	Q-ODC plug	≤ 450 N tensile load ≤ 30 N static side load
	Q-ODC socket	≤ 30 N tensile load
Operating temperature ¹⁾	IEC 61300-2-22	-40 up to +85 °C
Mating durability	IEC 61300-2-2	200 cycles ²⁾
Ingress protection (mated)	IEC 60529	IP67
Salt mist	IEC 61300-2-26	30 days passed
Vibration	IEC 61300-2-1	passed 10 to 500 Hz/10 g passed category 1A/B, 2, 3
	IEC 61373	
Shock	IEC 61300-2-9	passed 50 g passed category 1, 2
	IEC 61373	

¹⁾ depending on cable type

²⁾ with repeated cleaning

Optical performance

Insertion loss/IEC 61300-3-34	single-mode	typ. ≤ 0.20 dB	97 % ≤ 0.45 dB
	multimode	typ. ≤ 0.20 dB	97 % ≤ 0.50 dB
Return loss	single-mode	≥ 50 dB	0.30

Q-ODC-2 Industry

Type QO15 / QO16: Q-ODC-2 plug

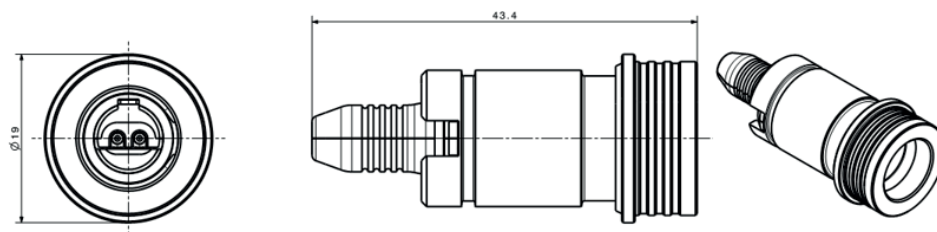

Type QOE5 / QOE6: Q-ODC-2 extension connector

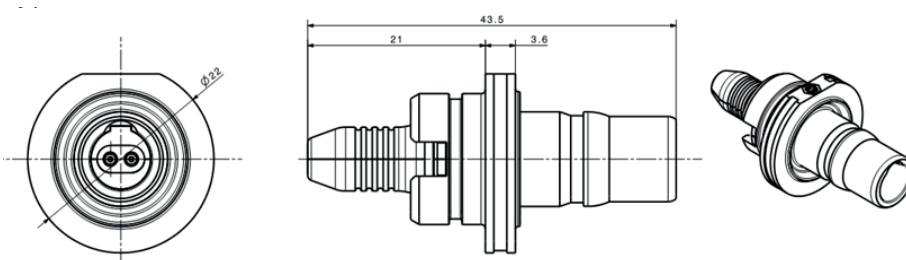

Q-ODC® outdoor connector plug/extension

Overview of Q-ODC connector types

Type new	Connector		Dust cap		
QO15	Q-ODC plug		push-on	IP67	
QO16			push-on	IP67	
QO17			snap-on	IP67	
QO18			snap-on with chain	IP67	
QOE5	Q-ODC extension		push-on	IP67	
QOE6			push-on	IP67	
QOE7			snap-on	IP67	
QOE8			snap-on with chain	IP67	

Q-ODC-12/24

Q-ODC-12/24 outdoor connector

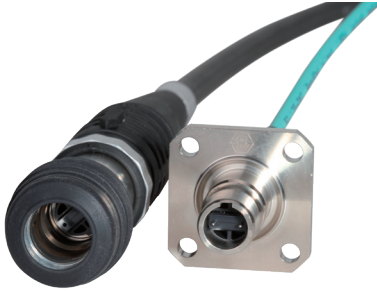

Features

- Up to 24 fibers, single-mode or multimode
- Compact design with MT ferrules
- Built-in socket with square flange/hexagonal flange
- Extension connector for cable chaining
- Robust push-pull coupling mechanism – two clearly defined mating states
- Highest outdoor installation safety
- Waterproof, dust proof and corrosion resistant
- Waterproof protection caps available
- RoHs compliant

Specifications

Technology		plastic ferrule (PPS)
Housing material		nickel-plated brass
Mating mechanism		push-pull with two clearly defined states
Mechanical performance	Q-ODC plug	≤ 500 N tensile load ≤ 30 N static side load
	Q-ODC socket	≤ 30 N static side load
Operating temperature ¹⁾	IEC 61300-2-22	-40 up to +85 °C
Mating durability	IEC 61300-2-2	100 cycles ²⁾
Ingress protection (mated)	IEC 60529	IP68 (3 m/30 days)
Salt mist	IEC 61300-2-26	30 days passed
Vibration	IEC 61300-2-1	passed 10 to 500 Hz/10 g
Shock	IEC 61300-2-9	passed 50 g
	IEC 61373	passed category 1, 2

¹⁾ depending on cable type

²⁾ with repeated cleaning

Optical performance

MTP performance by fiber type/grade

Fiber type/grade	typical IL (dB)	Maximum IL (dB)
Low-loss single-mode (SM MT Elite)	0.15	0.35
Low-loss multimode (MM MT Elite)	0.15	0.35

Mating/un-mating sequences

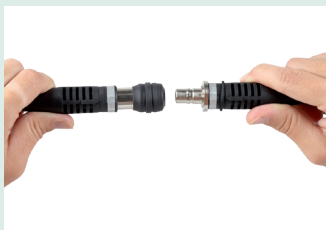

Push plug connector slightly into extension connector, rotate to find keying position, push connector to mate. Use arrows on a boot for pre-alignment.























Mated – connector snaps in and is fully strain relieved.



Pull coupling ring to un-mate.

Q-ODC-12/24

Q-ODC® outdoor connector plug / extension Overview of Q-ODC connector types

Type	Type new	Connector		Dust cap		
QX	QOI1	Q-ODC-12 / Q-ODC-24 plug		push-on	IP67	
	QOI2			push-on	IP67	
	QOI3			snap-on	IP67	
	QOI4			snap-on with chain	IP67	
QY	QOE1	Q-ODC-12 / Q-ODC-24 extension		push-on	IP67	
	QOE2			push-on	IP67	
	QOE3			snap-on	IP67	
	QOE4			snap-on with chain	IP67	
QZ	QOS1	Q-ODC-12 / Q-ODC-24 socket square		push-on	IP67	
	QOS2			push-on	IP67	
	QOS3			snap-on	IP67	
	QOS4			snap-on with chain	IP67	
QW	QOR1	Q-ODC-12 / Q-ODC-24 socket hexagonal, mounted from the rear, simplex cable		push-on	IP67	
	QOR2			push-on	IP67	
	QOR3			snap-on	IP67	
	QOR4			snap-on with chain	IP67	

Q-ODC-12/24 Industry

Q-ODC-12/24 Industry outdoor connector

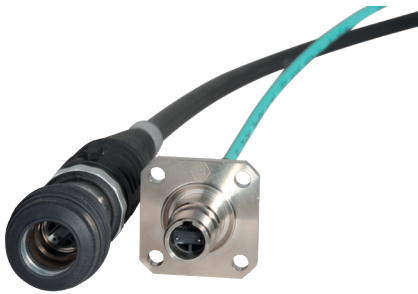

Features

- Up to 24 fibers, singlemode or multimode
- Compact design with MT ferrules
- Built-in socket with square flange/hexagonal flange
- Extension connector for cable chaining
- Robust push-pull coupling mechanism – two clearly defined mating states
- Highest outdoor installation safety
- Waterproof, dust proof and corrosion resistant
- Waterproof protection caps available
- RoHs compliant

Specifications

Technology		plastic ferrule (PPS)
Housing material		nickel-plated brass
Mating mechanism		push-pull with two clearly defined states
Mechanical performance	Q-ODC plug	≤ 500 N tensile load ≤ 30 N static side load
	Q-ODC socket	≤ 30 N tensile load
Operating temperature ¹⁾	IEC 61300-2-22	-40 up to +85 °C
Mating durability	IEC 61300-2-2	500 cycles ²⁾
Ingress protection (mated)	IEC 60529	IP 68 (3m/30 days)
Salt mist	IEC 61300-2-26	30 days passed
Vibration	IEC 61300-2-1	passed 10 to 500 Hz/10 g
Shock	IEC 61300-2-9	passed 50 g
	IEC 61373	passed category 1, 2

¹⁾ depending on cable type

²⁾ with repeated cleaning

Optical performance

MTP performance by fiber type/grade

Fiber type/grade	Typical IL (dB)	Maximum IL (dB)	RL
Low-loss singlemode (SM MT Elite)	0.15	0.35	≥ 60 dB
Low-loss multimode (MM MT Elite)	0.15	0.35	

Q-ODC-12/24 Industry

Standard type QOI1, QOI2, QOI3, QOI4: Q-ODC-12 / Q-ODC-24 Industry plug

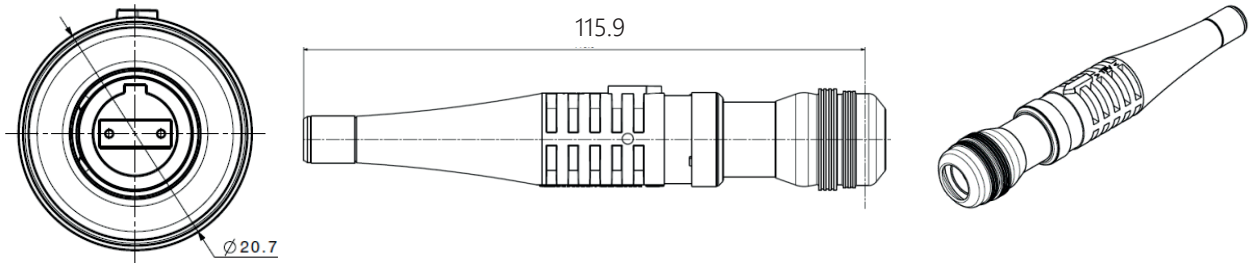

Standard type QOE1, QOE2, QOE3, QOE4: Q-ODC-12 / Q-ODC-24 extension

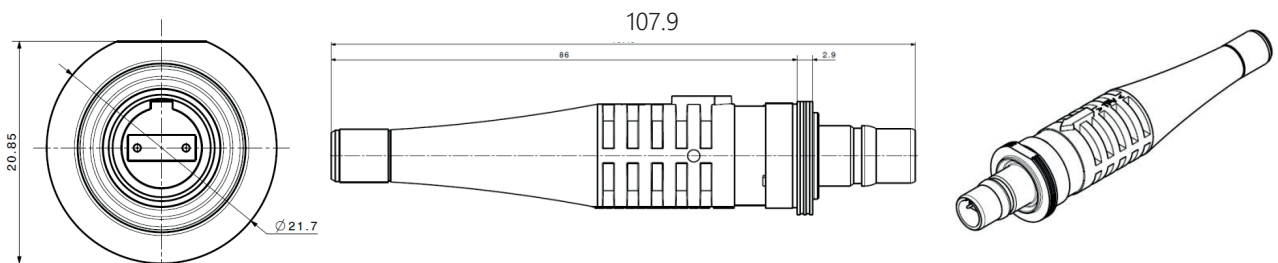

Standard type QOS1, QOS2, QOS3, QOS4: Q-ODC-12 / Q-ODC-24 socket square

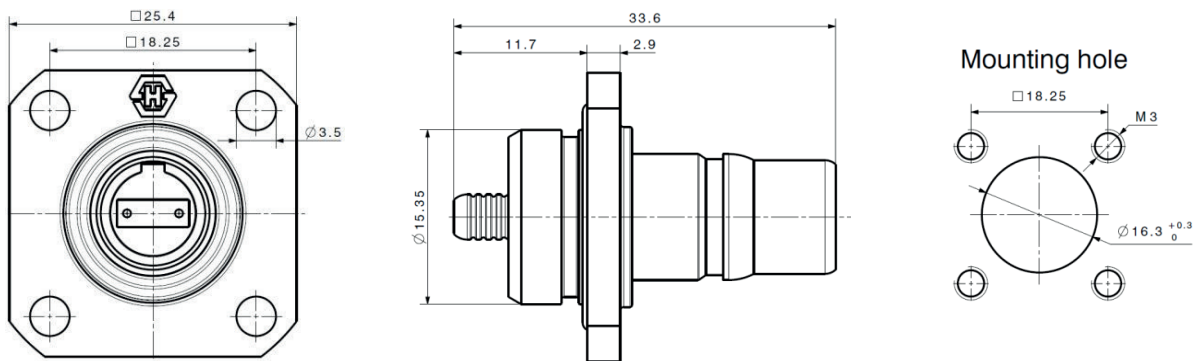

Standard type QOR1, QOR2, QOR3, QOR4: Q-ODC-12 / Q-ODC-24 socket hexagonal, mounted from the rear

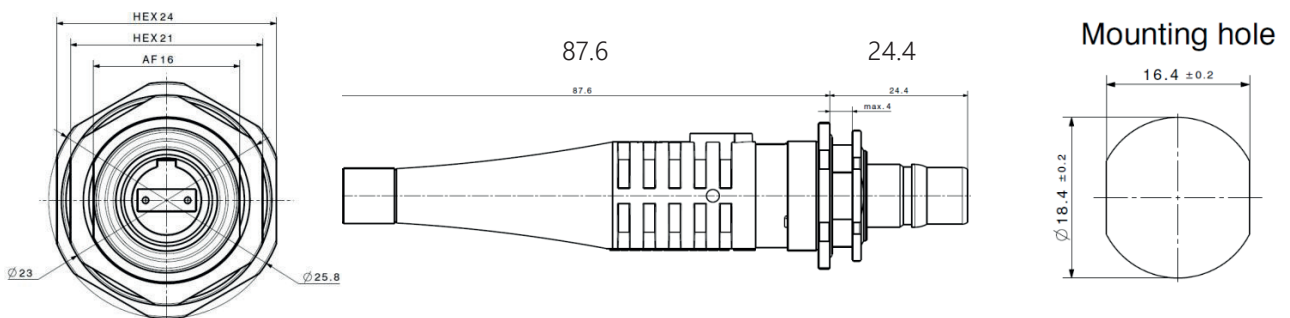

Hermaphroditic expanded beam connector EBC



Features

- 2 or 4 fibers, single-mode or multi-mode
- Expanded beam system
- Screwed locking mechanism
- Easy cable chaining possible due to hermaphroditic connector design
- Waterproof and dust proof
- Low sensitivity of contamination of optical end faces
- Easy cleaning and no maintenance required
- Meets requirement of MIL-DTL-83526/20 and 21

Specifications

Technology	hermaphroditic expanded beam system
Mechanical performance ¹⁾	1500 N tensile load
Free fall resistance	500 drops from 1.2 m height
Operating temperature ¹⁾	-46 to +85 °C
Storage temperature ¹⁾	-55 to +85 °C
Mating durability	min. 3000 cycles
Ingress protection (mated)	IP67

¹⁾ depending on cable type

Optical performance

Insertion loss	single-mode	(1310 nm/1550 nm)	typ. 1.0 dB, max. 2.0 dB
	multi-mode	(850 nm/1300 nm)	typ. 0.8 dB, max. 1.5 dB
Return loss	single-mode		typ. 30 dB

EBC plug

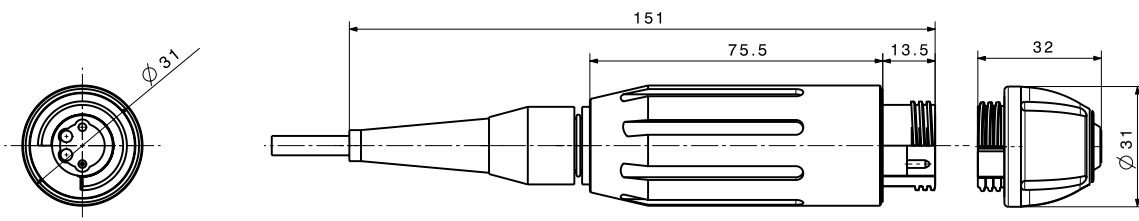

EBC bulkhead

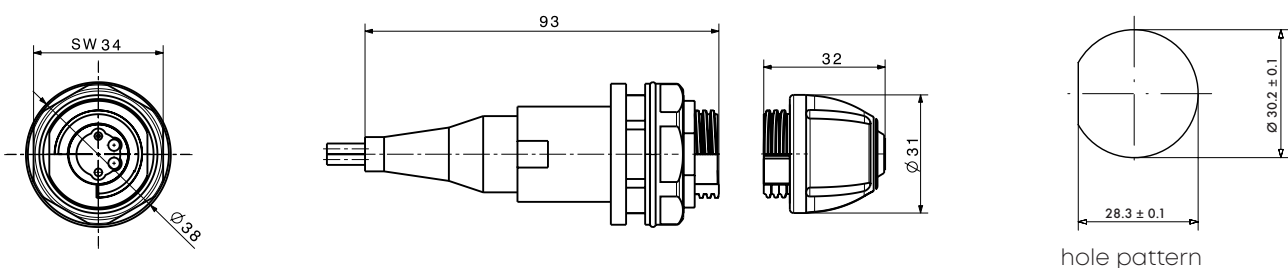







FO cable assemblies















HUBER+SUHNER can configure robust assemblies from a wide range of connectors and cables to meet customer requirements.

Universal cables and suitable connectors

	Cable type	Ordering key	Weight kg/km	Amount of fibers	Multifiber loose tube	Jacket Ø mm	Jacket material
	Non-armoured multi-fiber loose tube up to 24 fibers	12-.../BW(ZN)H-...35 24-.../W(ZN)H-...50	10.3 27	up to 12 up to 24	mini standard	3.5 5.0	LSFH™ LSFH™
	Glass-armoured multi-fiber loose tube up to 24 fibers	24-.../W(ZNG)H-...70 24-.../W(ZNG)H-...85 24-.../W(ZNG)H-...120	55 83 178	up to 24 up to 24 up to 24	standard standard standard	7.0 8.5 12.0	LSFH™ LSFH™ LSFH™
	Glass-armoured multi-fiber loose tube twintube up to 24 fibers	24-.../W(ZNG)H-...94	101	up to 24	standard	8.8 × 9.4	LSFH™
	Glass-armoured multi-fiber loose tube up to 144 fibers	24-.../BWSN(ZNG)H-...96 48-.../BWSN(ZNG)H-...96 72-.../BWSN(ZNG)H-...106 96-.../BWSN(ZNG)H-...122 144-.../BWSN(ZNG)H-...145	109 109 119 151 220	up to 24 up to 48 up to 72 up to 96 up to 144	mini mini mini mini mini	9.6 9.6 10.6 12.2 14.5	LSFH™ LSFH™ LSFH™ LSFH™ LSFH™
	Steel-armoured multi-fiber loose tube up to 24 fibers	24-.../W(ZN)HAH-...80	82	up to 24	standard	8.0	LSFH™
	Steel-armoured multi-fiber loose tube up to 72 fibers	24-.../W(ZNG)HAH-...125	200	up to 24	standard	12.5	LSFH™

Indoor cables and suitable connectors

	Cable type	Ordering key	Weight kg/km	Number of fibers	Tube Ø mm	Ø Single-fiber cable mm	Jacket Ø mm	Jacket material
	Optipack	12-.../(ZN)H-...20 12-.../(ZN)H-...30 24-.../(ZN)H-...30 24-.../(ZN)H-...36	3.6 8.0 8.3 11.0	8 od. 12 8 od. 12 24 24			2.0 3.0 3.0 3.6	LSFH™ LSFH™ LSFH™ LSFH™

ODC-2	ODC-4	Q-ODC-2*	Q-ODC-2 Industry*	Q-ODC-2 Mini*	Q-ODC-12/ Q-ODC-24*	Q-ODC-12 Industry/ Q-ODC-24 Industry*	XCO	Q-XCO	EBC with lenses	Other types e.g. ProBeam Jr.
										
					7.0 mm 8.5 mm	7.0 mm 8.5 mm				

ODC-2	ODC-4	Q-ODC-2*	Q-ODC-2 Industry*	Q-ODC-2 Mini*	Q-ODC-12/ Q-ODC-24*	Q-ODC-12 Industry/ Q-ODC-24 Industry*	XCO	Q-XCO	EBC with lenses	Other types e.g. ProBeam Jr.
										
					2.0 mm 3.0 mm 3.6 mm					

Special cables and suitable connectors

	Cable type	Ordering key	Weight kg/km	Amount of fibers	Tube Ø mm	Simplex cable Ø mm	Jacket Ø mm	Jacket material
	Industry Link TWINFLEX and rugged minicord breakout cables	02-.../FJ(ZN)Z-...17 02-.../...(ZN)Z-...22	28 46	2 2	0.9 0.9	1.7 2.2	6.0 7.5 x 8	TPU TPU
	Industry Link TWINFIX	02-.../...(ZNG)H-...22 02-.../...(ZNG)R-...22	61	2 2	0.9 0.9	2.2 2.2	7.5x7.2 7.5x7.2	LSFH™ RADOX®
	Industry link QUADFIX	04-.../FJSN(ZNG)H-...22 04-H200/VJSN(ZNG)H-...22	91	4	0.9	2.2	9.0	LSFH™
	Optiflex	12-.../EW(ZN)Z-...60	26	up to 12			6.0	TPU
	Mobile field cables	02-.../FSN(ZN)Z-...56 04-.../FSN(ZN)Z-...56 08-.../FSN(ZN)Z-...68 12-.../FSN(ZN)Z-...80	24 26 40 53	2 4 8 12	0.9 0.9 0.9 0.9		5.6 5.6 6.8 8.0	TPU TPU TPU TPU
	Glass-armoured riser cables 2 tubes	02-.../F(ZNG)H-...48 02-.../F(ZNG)H-...55 02-.../F(ZNG)H-...70	26 35 55	2 2 2	0.9 0.9 0.9		4.8 5.5 7.0	LSFH™ LSFH™ LSFH™
	Glass-armoured riser cables 4 tubes	04-.../FSN(ZNG)H-...55	33	4	0.9		5.5	LSFH™
	RADOX® loose tube cable up to 24 fibers	24-.../W(ZNG)R-...85	88	up to 24			8.5	RADOX®
	Steel armoured multi-fiber loose tube cable, up to 24 fibers	24-.../W(ZN)HAR-...82_DNV 24-.../W(ZN)HAH-...80 24-.../Q(ZN)HAU-...80	115 87 100	up to 24 up to 24 up to 24			8.2 8.0 8.0	RADOX® LSFH™ TPU
	DNV GL type approved multifiber loose tube cable – steel armoured, up to 24 fibers	24-.../W(ZN)HAR-...82_DNV	115	up to 24			8.2	RADOX®
	DNV GL type approved multifiber loose tube	24-.../W(ZNG)H-...120	178	up to 24			12	LSFH™
	Drag chain cables	12-.../FSN(ZN)YZ-...130	128	up to 12	0.9		13.0	TPU
	RADOX® drag chain cable	12-.../FSN(ZN)YR-...130	160	up to 12	0.9		13.0	RADOX®
	Rugged multifiber loose tube up to 24 fibers (dry)	24-.../Q(ZNG)Z-...70	44	2 to 24			7.0	TPU

Exemplary ODC-2 assemblies

ODC-2 plug to ODC-2 plug, multi-mode OM2 fiber



Length	Item no.	Assembly code
5 m	85003241	MR02_ODP2_ODP2_O256T_05.0_MM
10 m	85003242	MR02_ODP2_ODP2_O256T_10.0_MM
20 m	85016873	MR02_ODP2_ODP2_O256T_20.0_MM
30 m	85065892	MR02_ODP2_ODP2_O256T_30.0_MM
40 m	85065894	MR02_ODP2_ODP2_O256T_40.0_MM
50 m	85065897	MR02_ODP2_ODP2_O256T_50.0_MM
60 m	85065898	MR02_ODP2_ODP2_O256T_60.0_MM
70 m	85065899	MR02_ODP2_ODP2_O256T_70.0_MM
80 m	85065900	MR02_ODP2_ODP2_O256T_80.0_MM
90 m	85065901	MR02_ODP2_ODP2_O256T_90.0_MM
100 m	84133179	MR02_ODP2_ODP2_O256T_0100_MM
150 m	85065902	MR02_ODP2_ODP2_O256T_0150_MM
200 m	85065903	MR02_ODP2_ODP2_O256T_0200_MM

Connector left ODC-2 plug

Type	Connector	Dust cap
ODP2	ODC-2 plug 	screwed cap with chain IP68 

Connector right ODC-2 plug

Type	Connector	Dust cap
ODP2	ODC-2 plug 	screwed cap with chain IP68 

Used cable

Mobile field cables



Item no.	Cable type	Description
84096494	02-G50/FSN(ZN)Z-G56	2-fiber, 50/125 μm OM2, Ø 5.6 mm, jacket PUR black

Exemplary ODC-2 assemblies

ODC-2 plug to LC connector, multi-mode OM2 fiber



Length	Item no.	Assembly code
2 m	85002920	MR02_ODP2_LCMP_O260T_02.0_MM
4 m	85002159	MR02_ODP2_LCMP_O260T_04.0_MM
6 m	85004721	MR02_ODP2_LCMP_O260T_06.0_MM
8 m	85005832	MR02_ODP2_LCMP_O260T_08.0_MM
10 m	85065904	MR02_ODP2_LCMP_O260T_10.0_MM

Connector left ODC-2 plug

Type	Connector	Dust cap
ODP2	ODC-2 plug 	screwed cap with chain IP68 

Connector right LC connector

Type	Connector
LCMP	LC duplex 

Used cable

Rugged minicord breakout cables



Item no.	Cable type	Description
23037747	02-G50/FJ(ZN)Z-G17	2-fiber, 50/125 µm OM2, Ø 6.0 mm, jacket PUR black

Exemplary ODC-2 assemblies

ODC-2 socket to LC connector, multi-mode OM2 fiber



Length	Item no.	Assembly code
0.3 m	85065943	PC02_ODS2_LCMD_O219T_0.30_MM
0.5 m	85065944	PC02_ODS2_LCMD_O219T_0.50_MM
1 m	85065945	PC02_ODS2_LCMD_O219T_01.0_MM

Connector left ODC-2 socket

Type	Connector	Dust cap
ODS2	ODC-2 socket, square small 	screwed cap with chain IP68 

Connector right LC connector

Type	Connector
LCMD	LC duplex 

Used cable

Simplex cables 1.9 mm



Item no.	Cable type	Description
84032683	01-G50/FJU-D19	1-fiber, 50/125 µm OM2, Ø 1.9 mm, jacket PUR orange

Exemplary ODC-2 assemblies

ODC-2 socket to LC connector, multi-mode OM2 fiber



Length	Item no.	Assembly code
0.30 m	84150703	PC02_ODR2_LCMD_O219T_0.30_MM
0.50 m	85065949	PC02_ODR2_LCMD_O219T_0.50_MM
1.00 m	85065950	PC02_ODR2_LCMD_O219T_01.0_MM

Connector left ODC-2 socket

Type	Connector	Dust cap
ODR2	ODC-2 socket, hexagonal 	screwed cap with chain IP68 

Connector right LC connector

Type	Connector
LCMD	LC duplex 

Used cable

Simplex cables 1.9 mm



Item no.	Cable type	Description
84032683	01-G50/FJU-D19	1-fiber, 50/125 µm OM2, Ø 1.9 mm, jacket PUR orange

Exemplary ODC-4 assemblies

ODC-4 plug to ODC-4 plug, multi-mode OM2 fiber



Length	Item no.	Assembly code
5 m	85065970	MR04_ODP2_ODP2_O256T_05.0_MM
10 m	85065974	MR04_ODP2_ODP2_O256T_10.0_MM
20 m	85065977	MR04_ODP2_ODP2_O256T_20.0_MM
30 m	84138359	MR04_ODP2_ODP2_O256T_30.0_MM
40 m	85065978	MR04_ODP2_ODP2_O256T_40.0_MM
50 m	85065979	MR04_ODP2_ODP2_O256T_50.0_MM
60 m	84150210	MR04_ODP2_ODP2_O256T_60.0_MM
70 m	85065982	MR04_ODP2_ODP2_O256T_70.0_MM
80 m	85065984	MR04_ODP2_ODP2_O256T_80.0_MM
90 m	85065985	MR04_ODP2_ODP2_O256T_90.0_MM
100 m	85065986	MR04_ODP2_ODP2_O256T_0100_MM
150 m	85065999	MR04_ODP2_ODP2_O256T_0150_MM
200 m	85066000	MR04_ODP2_ODP2_O256T_0200_MM

Connector left ODC-4 plug

Type	Connector	Dust cap
ODP2	ODC-4 plug 	screwed cap with chain IP68 

Connector right ODC-4 plug

Type	Connector	Dust cap
ODP2	ODC-4 plug 	screwed cap with chain IP68 

Used cable

Glass-armoured riser cables with 4 fibers



Item no.	Cable type	Description
84075876	04-G50/FSN(ZNG)H-G55	4-fiber, 50/125 µm OM2, Ø 5.5 mm jacket LSFH black

Exemplary ODC-4 assemblies

ODC-4 socket to LC connector, multi-mode OM2 fiber



Length	Item no.	Assembly code
0.30 m	85066013	PC04_ODS2_LCMD_O219T_0.30_MM
0.50 m	85066014	PC04_ODS2_LCMD_O219T_0.50_MM
1.00 m	85066016	PC04_ODS2_LCMD_O219T_01.0_MM

Connector left ODC-4 socket

Type	Connector	Dust cap
ODS2	ODC-4 socket; square 	screwed cap with chain IP68 

Connector right LC connector

Type	Connector
LCMD	LC duplex 

Used cable

Simplex cables 1.9 mm

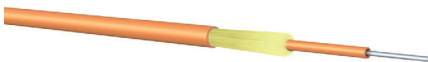

Item no.	Cable type	Description
84032683	01-G50/FJU-D19	1-fiber, 50/125 µm OM2, Ø 1.9 mm, jacket PUR orange

Exemplary ODC-4 assemblies

ODC-4 socket to SC connector, multi-mode OM2 fiber

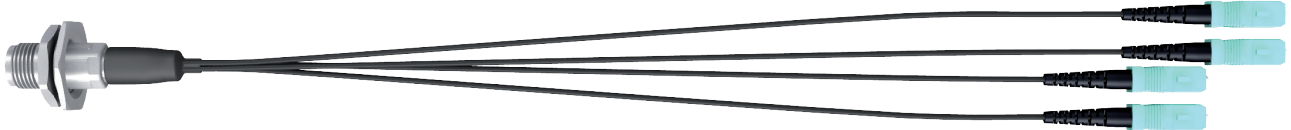

Length	Item no.	Assembly code
0.30 m	85066090	PC04_ODR2_SCMD_O219T_0.30_MM
0.50 m	85066091	PC04_ODR2_SCMD_O219T_0.50_MM
1.00 m	85066092	PC04_ODR2_SCMD_O219T_01.0_MM

Connector left ODC-4 socket

Type	Connector	Dust cap
ODR2	ODC-4 socket, hexagonal 	screwed cap with chain IP68 

Connector right SC connector

Type	Connector
SCMD	SC duplex 

Used cable

Simplex cables 1.9 mm

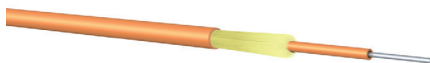

Item no.	Cable type	Description
84032683	01-G50/FJU-D19	1-fiber, 50/125 μm OM2, Ø 1.9 mm, jacket PUR orange

Exemplary ODC-4 assemblies

ODC-4 plug to LC connector, multi-mode OM2 fiber



Length	Item no.	Assembly code
2 m	85066001	MR04_ODP2_LCMP_O255T_02.0_MM
4 m	85066002	MR04_ODP2_LCMP_O255T_04.0_MM
6 m	85066003	MR04_ODP2_LCMP_O255T_06.0_MM
8 m	85066004	MR04_ODP2_LCMP_O255T_08.0_MM
10 m	85066005	MR04_ODP2_LCMP_O255T_10.0_MM

Connector left ODC-4 plug

Type	Connector	Dust cap
ODP2	ODC-4 plug 	screwed cap with chain IP68 

Connector right LC connector

Type	Connector
LCMP	LC duplex 

Used cable

Glass-armoured riser cables with 4 fibers



Item no.	Cable type	Description
84075876	04-G50/FSN(ZNG)H-G55	4-fiber, 50/125 µm OM2, Ø 5.5 mm jacket LSFH black

Exemplary Q-ODC-2 assemblies

Q-ODC-2 plug to Q-ODC-2 plug, multi-mode OM2 fiber



Length	Item no.	Assembly code
5 m	85066094	MR02_QOP2_QOP2_O256T_05.0_MM
10 m	85066095	MR02_QOP2_QOP2_O256T_10.0_MM
20 m	85066096	MR02_QOP2_QOP2_O256T_20.0_MM
30 m	85066097	MR02_QOP2_QOP2_O256T_30.0_MM
40 m	85066098	MR02_QOP2_QOP2_O256T_40.0_MM
50 m	85066099	MR02_QOP2_QOP2_O256T_50.0_MM
60 m	85066100	MR02_QOP2_QOP2_O256T_60.0_MM
70 m	85066101	MR02_QOP2_QOP2_O256T_70.0_MM
80 m	85066102	MR02_QOP2_QOP2_O256T_80.0_MM
90 m	85066103	MR02_QOP2_QOP2_O256T_90.0_MM
100 m	85066104	MR02_QOP2_QOP2_O256T_0100_MM
150 m	85066105	MR02_QOP2_QOP2_O256T_0150_MM
200 m	85066107	MR02_QOP2_QOP2_O256T_0200_MM

Connector left Q-ODC-2 plug

Type	Connector	Dust cap
QOP2	Q-ODC-2 plug 	push-on IP67 

Connector right Q-ODC-2 plug

Type	Connector	Dust cap
QOP2	Q-ODC-2 plug 	push-on IP67 

Used cable

Mobile field cables



Item no.	Cable type	Description
84096494	02-G50/FSN(ZN)Z-G56	2-fiber, 50/125 μm OM2, Ø 5.6 mm, jacket PUR black

Exemplary Q-ODC-2 assemblies

Q-ODC-2 plug to LC connector, multi-mode OM2 fiber



Length	Item no.	Assembly code
2 m	85066108	MR02_QOP2_LCMP_O260T_02.0_MM
4 m	85066109	MR02_QOP2_LCMP_O260T_04.0_MM
6 m	85066110	MR02_QOP2_LCMP_O260T_06.0_MM
8 m	85066112	MR02_QOP2_LCMP_O260T_08.0_MM
10 m	85066113	MR02_QOP2_LCMP_O260T_10.0_MM

Connector left Q-ODC-2 plug

Type	Connector	Dust cap
QOP2	Q-ODC-2 plug 	push-on IP67 

Connector right LC connector

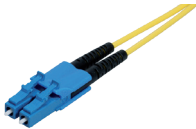
Type	Connector
LCMP	LC duplex 

Used cable

Rugged minicord breakout cables



Item no.	Cable type	Description
23037747	02-G50/FJ(ZN)Z-G17	2-fiber, 50/125 µm OM2, Ø 6.0 mm, jacket PUR black

Exemplary Q-ODC-2 assemblies

Q-ODC-2 plug to LC connector, multi-mode OM3 fiber



Length	Item no.	Assembly code
2 m	85002965	MR02_QOP4_LCMD_O355T_02.0_MM
5 m	85002966	MR02_QOP4_LCMD_O355T_05.0_MM
10 m	85002967	MR02_QOP4_LCMD_O355T_10.0_MM

Connector left Q-ODC-2 plug

Type	Connector	Dust cap
QOP4	Q-ODC-2 plug 	snap-on with chain IP67 

Connector right LC connector

Type	Connector
LCMD	LC duplex 

Used cable

Glass-armoured riser cables with 2 fibers



Item no.	Cable type	Description
84106966	02-G50/F(ZNG)H-G55-F	2-fiber, 50/125 µm OM3, Ø 5.5 mm, jacket LSFH black

Exemplary Q-ODC-2 assemblies

Q-ODC-2 socket to LC connector, multi-mode OM2 fiber



Length	Item no.	Assembly code
0.30 m	85066119	PC02_QOS4_LCMD_O219T_0.30_MM
0.50 m	85066121	PC02_QOS4_LCMD_O219T_0.50_MM
1.00 m	85066122	PC02_QOS4_LCMD_O219T_01.0_MM

Connector left Q-ODC-2 socket

Type	Connector	Dust cap
QOS4	Q-ODC-2 socket, square 	snap-on with chain IP67 

Connector right LC connector

Type	Connector
LCMD	LC duplex 

Used cable

Simplex cables 1.9 mm



Item no.	Cable type	Description
84032683	01-G50/FJU-D19	1-fiber, 50/125 µm OM2, Ø 1.9 mm, jacket PUR orange

Exemplary Q-ODC-2 assemblies

Q-ODC-2 socket to LC connector, multi-mode OM2 fiber



Length	Item no.	Assembly code
0.30 m	85066126	PC02_QOR2_LCMD_O219T_0.30_MM
0.50 m	85066127	PC02_QOR2_LCMD_O219T_0.50_MM
1.00 m	85066128	PC02_QOR2_LCMD_O219T_01.0_MM

Connector left Q-ODC-2 socket

Type	Connector	Dust cap
QOR2	Q-ODC 2 socket, hexagonal 	push-on IP67 

Connector right LC connector

Type	Connector
LCMD	LC duplex 

Used cable

Simplex cables 1.9 mm

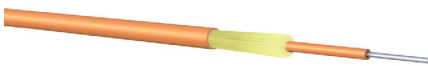

Item no.	Cable type	Description
84032683	01-G50/FJU-D19	1-fiber, 50/125 µm OM2, Ø 1.9 mm, jacket PUR orange

Exemplary Q-ODC-12/ Q-ODC-24 assemblies

Q-ODC-12 plug to Q-ODC-12 extension, multi-mode OM2 fiber





Length	Item no.	Assembly code
10 m	85026180	MB12_QOP2_QOE2_O270R_10.0_LL
20 m	85015744	MB12_QOP2_QOE2_O270R_20.0_LL
30 m	85026245	MB12_QOP2_QOE2_O270R_30.0_LL
40 m	85026246	MB12_QOP2_QOE2_O270R_40.0_LL
50 m	85026247	MB12_QOP2_QOE2_O270R_50.0_LL
60 m	85026248	MB12_QOP2_QOE2_O270R_60.0_LL
70 m	85026249	MB12_QOP2_QOE2_O270R_70.0_LL
80 m	85026250	MB12_QOP2_QOE2_O270R_80.0_LL
90 m	85026251	MB12_QOP2_QOE2_O270R_90.0_LL
100 m	85026252	MB12_QOP2_QOE2_O270R_0100_LL
150 m	85026257	MB12_QOP2_QOE2_O270R_0150_LL

Connector left Q-ODC-12 plug

Type	Connector		Dust cap	
QOP2	Q-ODC-12 plug		push-on IP67	

Connector right Q-ODC-12 extension

Type	Connector		Dust cap	
QOE2	Q-ODC-12 extension		push-on IP67	

Used cable

Jellyfree – dry block glass-armoured multi-fiber loose tube cables 7.0 mm



Item no.	Cable type	Description
85026737	12-12G50/H(ZNG)H-G70-UR	12-fiber, 50/125 µm OM2, Ø 7.0 mm, jacket LSFH black UL rating acc. OFN/OFNG

Exemplary Q-ODC-12 assemblies

Q-ODC-12 plug to Q-ODC-12 socket, multi-mode OM2 fiber





Length	Item no.	Assembly code
20 m	85020914	70HRCG-50-QX/QW-020-TT-B

Connector left Q-ODC-12 plug

Type	Connector		Dust cap	
QOP2	Q-ODC-12 plug		push-on IP67	

Connector right Q-ODC-12 socket

Type	Connector		Dust cap	
QOR1	Q-ODC-12 socket, hexagonal		push-on IP67	

Used cable

Jellyfree glass-armoured multi-fiber loose tube cables



Item no.	Cable type	Description
85008097	12-12G50/H(ZNG)H-G70	12-fiber, 50/125 µm OM2, Ø 7.0 mm, jacket LSFH black



Exemplary Q-ODC-12 assemblies

Q-ODC-12 socket to LC connector, multi-mode OM3 fiber



Length	Item no.	Assembly code
5 m	85015759	PC312-X0005A-S00000G045ZQZ88LM

Connector left Q-ODC-12 socket

Type	Connector		Dust cap	
QOS2	Q-ODC-12 socket, square		push-on IP67	

Connector right LC connector

Type	Connector	
LCMD	6 × LC duplex	

Used cable

OptiPack 12 – 3.0 mm multi-fiber patch cable



Item no.	Cable type	Description
84150817	12-12G50/(CH)H-M30-F OM3	12-fiber, 50/125 μm OM3 BendOptimized, Ø 3.0 mm, jacket LSFH turquoise



Exemplary Q-ODC-12 assemblies

Glass-armoured 12 fiber loose-tube cable with Q-ODC-12 extension and LC uniboot connectors



Length	Item no. fiber type single-mode	
	Cable type LSFH, not UL listed	Cable type LSFH, UL listed
20 m	85032143	85032158
30 m	85032144	85032159
40 m	85032145	85032160
50 m	85032146	85032161
60 m	85032147	85032162
70 m	85032148	85032163
80 m	85032149	85032164
90 m	85032150	85032165
100 m	85032151	85032166
125 m	85032152	85032167
150 m	85032154	85032169
200 m	85032155	85032170

Connector left Q-ODC-12 extension

Type	Connector		Dust cap	
QOE2	Q-ODC-12 extension		push-on IP67	

Connector right LC uniboot

Type	Connector	
LCMU	6 × LC uniboot	

Used cable

Jellyfree glass-armoured multi-fiber loose tube cables



Item no.	Cable type	Description
85008097	12-12G50/H(ZNG)H-G70	12-fiber, 50/125 μm OM2, Ø 7.0 mm, jacket LSFH black

Exemplary Q-XCO assemblies

Q-XCO to LC connector, multi-mode OM2 fiber assemblies



Length	Item no.	Assembly code
5 m	85008105	MR02_QXP2_LCMP_0255T_0.50_MM
25 m	85008107	MR02_QXP2_LCMP_0255T_25.0_MM
50 m	85008106	MR02_QXP2_LCMP_0255T_50.0_MM
80 m	85008108	MR02_QXP2_LCMP_0255T_80.0_MM
100 m	85008109	MR02_QXP2_LCMP_0255T_0100_MM
120 m	85008110	MR02_QXP2_LCMP_0255T_0120_MM
140 m	85008111	MR02_QXP2_LCMP_0255T_0140_MM
160 m	85008112	MR02_QXP2_LCMP_0255T_0160_MM
180 m	85008113	MR02_QXP2_LCMP_0255T_0180_MM
200 m	85008114	MR02_QXP2_LCMP_0255T_0200_MM

Connector left Q-XCO plug

Type	Connector	Dust cap
QXP2	Q-XCO 	IP67 

Connector right LC connector

Type	Connector
LCMP	LC duplex 

Used cable

Glass-armoured riser cables with 2 fibers



Item no.	Cable type	Description
84066685	02-G50/FSN(ZNG)H-G55	2-fiber, 50/125 µm OM2, Ø 5.5 mm, jacket LSFH black

MASTERLINE Ultimate with Q-ODC-12/24 (MLUQ)



Features

- Pre-connectorised factory-sealed “plug & play” fiber optic cabling system for up to 12 RRHs
- Modular RRH installation solution - connector head and multi-fiber cable can be installed separated
- Q-ODC-12 or Q-ODC-24 connectivity between the connector head and multi-fiber cable
- Connectorized multi-fiber cable can be installed through a hole with a minimum diameter of only 22mm
- Robust connector head with 6 or 12 Q-ODC-2 sockets to connect the RRH with Q-ODC-2 fiber optic jumpers
- Easy and time-saving installation

Specifications

Connector head		
Number of Q-ODC-2 connector socket		6 or 12
Number of Q-ODC-12/24 connector socket (reverse plug)		1
Dimensions L × W × H	enclosure without cover	293 × 110 × 46 mm
	enclosure with cover	460 × 160 × 110 mm
Temperature range	during installation	-10 up to +50 °C
	in service	-40 up to +75 °C
Ingress protection		IP67
Impact resistance		IK 07
UV resistant for outdoor use		ISO 4892-3
Mounting bracket material		stainless steel
Multi-Fiber cable		
Cable type		glass-armoured multi-fiber loose-tube cable
Jacket material		LSFH, black
Cable diameter		7.0 mm
Cable tensile strength	during installation	2000 N
	in service	1200 N
Minimum bending radius	during installation	110 mm
	in service	70 mm
Fire propagation		IEC 60332-1 and IEC 60332-3-25
Cable crush resistance	short-term	500 N/cm
	long-term	200 N/cm



Optional protective cover for connector is also available.

MASTERLINE Ultimate with Q-ODC-12/24 (MLUQ)

Ordering information

MASTERLINE Ultimate with Q-ODC-12/24 (MLUQ) and multi-fiber cable connectorized with Q-ODC-12/24 extension and 6/12 × LC duplex connector



MLUQ connector head

Item no. MLUQ connector head with 12 fiber, 6 × Q-ODC-2 socket and 1 × Q-ODC-12 socket (reverse plug) including mounting bracket Fiber type: single mode 85089691	Item no. MLUQ connector head with 24 fiber, 12 × Q-ODC-2 socket and 1 × Q-ODC-24 socket (reverse plug) including mounting bracket Fiber type: single mode 85089688
---	--

Connectorized multi-fiber cable

Length	Item no. Multi-fiber cable connectorized with Q-ODC-12 extension and 6 × LC duplex connector, 12 fiber Fiber type: single mode	Item no. Multi-fiber cable connectorized with Q-ODC-24 extension and 12 × LC duplex connector, 24 fiber Fiber type: single mode
20 m	85032143	85096335
30 m	85032144	85096336
40 m	85032145	85096337
50 m	85032146	85096338
60 m	85032147	85096339
70 m	85032148	85096340
80 m	85032149	85096341
90 m	85032150	85096342
100 m	85032151	85096343



Q-ODC-12/24 extension with pulling eye cap



MASTERLINE Classic with LC duplex connector at BTS side

MASTERLINE Extreme (MLE) with Q-ODC



Features

- Pre-assembled „plug & play“ cabling system
- Terminated with Q-ODC extension connectors on RRH side
- Adaptation to any RRH interface with Q-ODC plug jumpers
- BTS side terminated with LC uniboot connectors
- Ruggedised design with robust break-out cables
- Robust pulling tube for cable lifting
- Loose tube cables with 12 or 24 fibers, rodent protected and UV resistant and CPR compliant
- Connectors numbered for easy channel identification
- Easy and time-saving installation



Specifications

Number of fibers		12	24
Build-in hole dimension divider BTS side		15.6 to 16.4 mm	
Outer diameter divider	RRH side	22.0 mm	28.0 mm
Tensile load on individual break-out cables		600 N	
Ingress protection with Q-ODC connector		IP67	
Break-out lengths		0.55/0.64 m	0.55/0.64/0.73/0.82 m
Break-out cable diameter		5 mm	
Cable type		glass-armoured multi-fiber loose-tube cable	
Jacket material		LSFH™, black	
Cable diameter		7.0 mm	
Cable tensile strength	during installation in service	2000 N 1200 N	
Cable crush resistance	short-term long-term	500 N/cm 200 N/cm	
Temperature range	installation in service	-10 to +50 °C -40 to +75 °C	
Fire propagation		IEC 60332-1 and IEC 60332-3-25	
CPR compliant		class Dca-s2,d1,a1	
Flame resistance	IEC 60332-1, IEC 60332-3-24	passed	
Pulling tube with pulling eye	outer diameter	60 mm	
Protection tube BTS side	outer diameter	36 mm	



LC uniboot at BTS side



Protecting tube at BTS side



Pulling tube with pulling eye

MASTERLINE Extreme (MLE) with Q-ODC



Ordering information

MASTERLINE Extreme with Q-ODC extensions and LC uniboot connectors.



Length	Item no. Fiber type: single-mode				Item no. Fiber type: multimode OM3	
	Cable type: LSFH™, not UL listed		Cable type: LSFH™, UL listed		Cable type: LSFH™, not UL listed	
	12 fibers – 6 RRH	24 fiber– 12 RRH	12 fibers – 6RRH	24 fibers – 12 RRH	12 fibers – 6RRH	24 fibers – 12 RRH
20 m	85005467	85005609	85004452	85004479	85009293	85014283
30 m	85005468	85005610	85004453	85004481	85009294	85014284
40 m	85005469	85005611	85004454	85004482	85009295	85014285
50 m	85005470	85005612	85004455	85004483	85009064	85014286
60 m	85005471	85005613	85004456	85004484	85009296	85014287
70 m	85005472	85005614	85004457	85004485	85009297	85014288
80 m	85005473	85005615	85004458	85004486	85009299	85014289
90 m	85005474	85005616	85004459	85004487	85009300	85014300
100 m	85005475	85005617	85004460	85004488	85009301	85014301
125 m	85005478	85005620	85004461	85004489	85014280	85014302
150 m	85005479	85005621	85004462	85004490	85014281	85014303
200 m	85005480	85005622	85004463	85004491	85014282	85014304

Options

- Multimode OM3, UL listed
- Other length



Supplied on a double-flange reel

MASTERLINE Extreme (MLE) with Q-ODC-12



Ordering information

Glass-armoured 12 fiber loose-tube cable with Q-ODC-12 extension and LC uniboot connectors



Length	Item no. fiber type single-mode	
	Cable type LSFH™, not UL listed	Cable type LSFH™, UL listed
20 m	85032143	85032158
30 m	85032144	85032159
40 m	85032145	85032160
50 m	85032146	85032161
60 m	85032147	85032162
70 m	85032148	85032163
80 m	85032149	85032164
90 m	85032150	85032165
100 m	85032151	85032166
125 m	85032152	85032167
150 m	85032154	85032169
200 m	85032155	85032170



Supplied on a double-flange reel



Q-ODC-12 extension with
plastic push-on cap (IP67)

MASTERLINE Extreme (MLE) with Q-ODC-12

Q-ODC-12 multi-branch jumper

Ordering information

Q-ODC-12 multi-branch jumper with 6 LC duplex, ruggedized break-out 85 mm long and cable Ø 5.0 mm, single-mode fiber



Total length	Branch break-out length	Item no.
3 m	2 m	85032212

Q-ODC-12 multi-branch jumper with 6 LC duplex, ruggedized break-out 90 mm long and cable Ø 5.0 mm (Ø 7.0 mm at the prechamber entry position), single-mode fiber



Total length	Branch break-out length	Item no.
3 m	2 m	85032214

Q-ODC-12 multi-branch jumper with 2, 3 and 4 branch, mixed interface and different length are available on request.

MASTERLINE Classic (MLC)



Features

- Pre-assembled „plug & play“ cabling system
- Ruggedised design with robust pulling tube
- Outdoor and indoor with high flame resistance
- Temperature range -40 up to +75 °C
- Ingress protection IP67 when installed
- Loose tube cables with up to 48 fibers, rodent protected and UV resistant and CPR compliant
- Both sides terminated with LC uniboot connectors
- Breakouts numbered for easy channel identification
- Easy and time-saving installation
- Each system factory tested

Specifications

		MLC 12 fiber	MLC 24 fiber	MLC 36 fiber	MLC 48 fiber
Number of fibers		12	24	36	48
Number of LC-HQ duplex uniboot connectors each side		6	12	18	24
Build-in hole dimension	FTTA box side	15.6 to 16.4 mm	25.5 to 26.5 mm	25.5 to 26.5 mm	25.5 to 26.5 mm
	BTS side	15.6 to 16.4 mm	15.6 to 16.4 mm	25.5 to 26.5 mm	25.5 to 26.5 mm
Cable type		Glass-armoured multifiber loose tube cable			
Jacket material		LSFH™, black			
Cable diameter		7.0 mm		9.6 mm	
Minimum bending radius	during installation	110 mm		140 mm	
	in service	70 mm		100 mm	
Temperature range	during installation	-10 to +50 °C			
	in service	-40 to 75 °C			
Ingress protection		IP67, when installed with FTTA box			
Halogen-free		IEC 60754-1			
Fire propagation		IEC 60332-1 and IEC 60332-3-25			
CPR compliant		class D _{co} s1a, d0, a1			
Pulling tube with pulling eye	outer diameter	36 mm			50 mm
Protection tube BTS side	outer diameter	36 mm			50 mm



Protecting tube at BTS side



Pulling tube with pulling eye at RRH side

MASTERLINE Classic (MLC)

Ordering information



Length	Item no. :					
	12 fibers/6 RRH		24 fibers/12 RRH		36 fibers/18 RRH	48 fibers/24 RRH
	single-mode E9/125 A2	multimode G50/125 OM3	single-mode E9/125 A2	multimode G50/125 OM3	single-mode E9/125 A2	single-mode E9/125 A2
20 m	85012382	85004878	85012383	85142756	85066843	85074331
30 m	85012502	85004879	85012589	85142757	85066962	85074332
40 m	85012503	85004880	85012590	85142758	85066964	85074333
50 m	85012504	85004881	85012592	85142759	85066966	85074334
60 m	85012505	85004882	85012593	85142768	85066979	85074335
70 m	85012506	85004883	85012594	85142769	85066986	85074336
80 m	85012543	85004884	85012595	85142780	85066987	85074337
90 m	85012544	85004885	85012596	85087968	85066988	85074338
100 m	85012545	85004886	85012597	85142781	85066989	85074339
125 m	85012546	85004887	85012598	85142782	85068299	85074340

Option:

- Other lengths available
- Multimode OM4

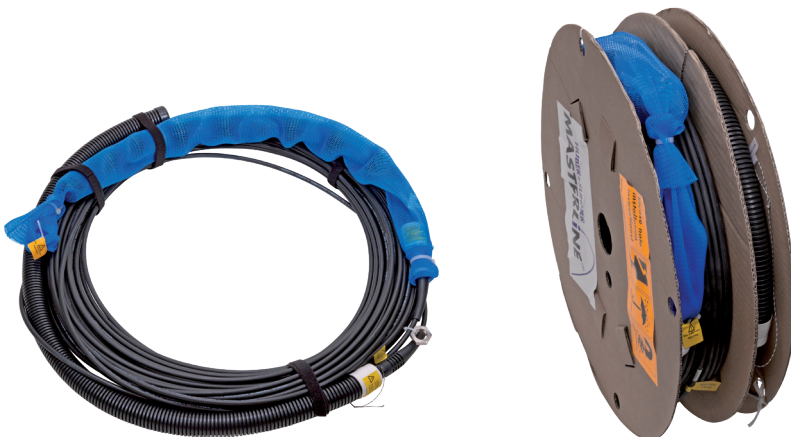

Up to 80 m supplied as air ring and for longer cable systems on a double-flange reel

MASTERLINE Classic (MLC)



Features

- Jumper available for all types of remote radios
- Cable diameter 4.8 mm, 5.5 mm or 7 mm
- Standard lengths of 2 m and 5 m, any customised length available

Ordering information

LC duplex to ODC plug, jumper cable Ø 5.5 mm



Length	Item no. single-mode E9/125 A1 (G.657.A1)
2 m	84122152
5 m	84078725

LC duplex to LC duplex with moulded divider and ruggedised break-out 98 mm long, cable Ø 4.8 mm cable



Length	Item no. single-mode E9/125 A2 (G.657.A2)
2 m	85031793
5 m	85031794

LC duplex to LC duplex jumper, with metal divider and ruggedised break-out 90 mm long, cable Ø 4.8 mm



Length	Item no. single-mode E9/125 A2 (G.657.A2)
2 m	84142320
5 m	84142321

MASTERLINE Classic (MLC)

LC duplex to FullAXS jumper, cable Ø 4.8 mm



Length	Item no. single-mode E9/125 A2 (G.657.A2)
2 m	84137910
5 m	84137911

LC duplex to LC duplex jumper with ruggedised break-out 85 mm long, cable Ø 5.5 mm



Length	Item no. single-mode E9/125 A2 (G.657.A2)	Item no. multimode G50/125 OM3
2.5 m	84122419	84122420
5 m	84122418	84104136

LC duplex to LC duplex jumper with ruggedised break-out 90 mm long, cable Ø 4.8 mm (Ø 7.0 mm at the RRH pre-chamber entry position), single-mode bend insensitive fiber



Length	Item no. single-mode E9/125 A2 (G.657.A2)	Item no. multimode G50/125 OM3
2 m	85015008	85140777
3 m	85015009	85140778
5 m	85015010	85140780

LC duplex to PDLC, jumper cable Ø 7 mm



Length	Item no. single-mode E9/125 A2 (G.657.A2)
2 m	84150634
5 m	84150635

LC duplex RRH jumper for other OEM interfaces

Please contact HUBER+SUHNER for LC duplex RRH jumper for other OEM interfaces which are not listed above.

Options:

- Other lengths available
- Multimode OM4

FO accessories



If you need a general cable system for location-independent communication transmission, or as a backup and contingency solution, the combination of MASTERLINE Classic and rugged cables gives you the ultimate solution: MASTERLINE Mobile.

MASTERLINE Mobile

Fan-out with protection tube

The single fiber optic cables of the fan-out have a black PUR jacket with 2.7 mm diameter. The longest length of the fan-out is 1165 mm and has a graduation of 65 mm. For installation purposes the fan-out legs and fiber optic connectors are protected by a robust protection tube. It provides a solid crush- or step-protection of the connectors and seals the fan-outs from any water ingress (IP67). The pulling eye allows to pull-in the cable system.



Fan-out

	2 fiber	4 fiber	8 fiber	12 fiber
Longest length	1165 mm			
Shortest length	1100 mm	970 mm	710 mm	450 mm
Graduation	65 mm			
Jacket material	black PUR			
Cable diameter	5.6 mm	5.6 mm	6.8 mm	8.0 mm

Protection tube

	2 fiber	4 fiber	8 fiber	12 fiber
Ingress protection	IP67			
Maximum tensile strength	450 N			
Crush resistance	1000 N/dm			
Pulling tube diameter	23.5 mm		31 mm	

MASTERLINE Mobile

Cable reel with cable – ready for use

Ordering information

Connector	Number of fibers	Cable length	Reel type	Item No. single-mode (E9/125, G.652.D)	Item No. multimode (G50/125, OM2)	
LSH APC (E-2000TM) 	2	150 m	MRPO 290	85099227	85099261	
		300 m	MRPS 400	85099228	85099262	
	4	150 m	MRPO 290	85099229	85099263	
		300 m	MRPS 400	85099230	85099264	
	8	150 m	MRPO 290	85099231	85099265	
		300 m	MRPO 485	85099232	85099266	
	12	150 m	MRPS 400	85099233	85099267	
		300 m	MRMS 680	85099234	85099268	
	ST 	2	150 m	MRPO 290	85099235	85099269
			300 m	MRPS 400	85099236	85099270
4		150 m	MRPO 290	85099237	85099271	
		300 m	MRPS 400	85099238	85099272	
8		150 m	MRPO 290	85099239	85099273	
		300 m	MRPO 485	85099240	85099274	
12		150 m	MRPS 400	85099241	85099275	
		300 m	MRMS 680	85099242	85099276	
SC 		2	150 m	MRPO 290	85099243	85099277
			300 m	MRPS 400	85099244	85099278
	4	150 m	MRPO 290	85099245	85099279	
		300 m	MRPS 400	85099246	85099280	
	8	150 m	MRPO 290	85099247	85099281	
		300 m	MRPO 485	85099248	85099282	
	12	150 m	MRPS 400	85099249	85099283	
		300 m	MRMS 680	85099250	85099284	
	LC-HQ push-pull (UPC) 	2	150 m	MRPO 290	85099251	85099285
			300 m	MRPS 400	85099252	85099286
4		150 m	MRPO 290	85099253	85099287	
		300 m	MRPS 400	85099254	85099288	
8		150 m	MRPO 290	85099255	85099289	
		300 m	MRPO 485	85099256	85099290	
12		150 m	MRPS 400	85099257	85099291	
		300 m	MRMS 680	85090529	85099292	

Options

- Other connectors available
- Other lengths available with consideration of the reel capacity

Contact your local sales representative for MASTERLINE Mobile Classic with above mentioned options

MASTERLINE Mobile

Fan-out for MLME

MASTERLINE Mobile Extreme with 2 connectors have a divider into 2 fan-out with 5.0 mm diameter and black PUR jacket. The longest length of the fan-out is 550 mm. For installation purposes the fan-out legs and fiber optic connectors are protected by a robust protection tube. It provides a solid crush- or step-protection of the connectors and seals the fan-outs from any water ingress (IP67). The pulling eye allows to pull-in the cable system.







Fan-out

	2 × ODC-2 or 2 × Q-ODC-2	2 × ODC-4
Longest length	550 mm	550 mm
Shortest length	450 mm	450 mm
Graduation	100 mm	100 mm
Jacket material	black PUR	black PUR
Cable diameter	5.6 mm	6.8 mm

MASTERLINE Mobile

Cable reel with cable – ready for use

Ordering information

Connector	Number of fibers	Cable length	Reel type	Item No. single-mode (E9/125, G.652.D)	Item No. multimode (G50/125, OM2)
	2	150 m	MRPO 290	85100158	85100144
		300 m	MRPS 400	85100159	85100145
	4	150 m	MRPO 290	85100160	85100146
		300 m	MRPS 400	85100161	85100147
	4	150 m	MRPO 290	85100162	85100148
		300 m	MRPS 400	85100163	85100149
	8	150 m	MRPO 290	85100164	85100150
		300 m	MRPO 485	85100165	85100151
	2	150 m	MRPO 290	85100166	85100152
		300 m	MRPS 400	85100167	85100153
	4	150 m	MRPO 290	85100168	85100154
		300 m	MRPS 400	85100169	85100155
	12	150 m	MRPS 400	85100170	85100156
		300 m	MRMS 680	85100171	85100157

Options

- Other connectors available
- Other lengths available with consideration of the reel capacity

Contact your local sales representative for MASTERLINE Mobile Classic with above mentioned options

MASTERLINE Mobile

Cable deployment reels

With our MASTERLINE Mobile Classic we provide a range of metallic and plastic cable deployment reels with different spooling capacities. All reels are specially designed for use with fiber optic cables. Minimum cable bending radii are maintained at all times in order to prevent increased attenuation even in coiled condition of the MASTERLINE Mobile.

	MRPO 290 *	MRPS 400	MRPO 485 *
	85093524	84018827	85093525
			

Cable capacity at cable Ø			
5.6 mm	290 m	400 m	485 m
6.0 mm	275 m	350 m	460 m
6.8 mm	235 m	285 m	405 m
7.0 mm	225 m	260 m	390 m
8.0 mm	175 m	200 m	310 m

Reel								
Inner core diameter	A	203 mm	A	295 mm		A	203 mm	
Reel height		198 mm		220 mm			213 mm	
Flange diameter		430 mm		440 mm			430 mm	
Width	B	520 mm	B	400 mm	C	550 mm	B	520 mm
Height		556 mm		555 mm		916 mm		556 mm
Depth		322 mm		320 mm		400 mm		398 mm
Material	reinforced polymer		Special rubber			reinforced polymer		
Colour	black		black			black		
Weight (without cable)	7.2 kg		7.0 kg			7.3 kg		

Carrier			
Type	frame with handle	frame with handle and optional with wheels and long handle	frame with handle

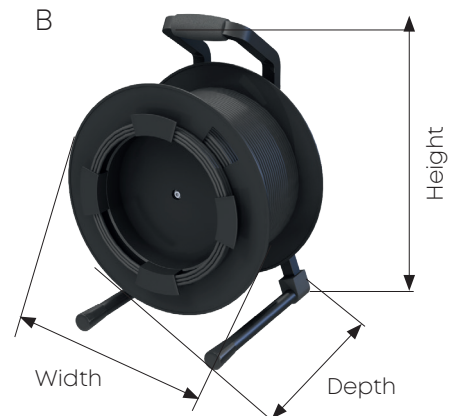

* Available without carrier frame (reel only)

MASTERLINE Mobile

	MRMS 680	MRPO 720 *	MRPO 975 *
	85090463	85093526	85093527
			

Cable capacity at cable Ø

5.6 mm	680 m	720 m	975 m
6.0 mm	590 m	685 m	850 m
6.8 mm	460 m	585 m	660 m
7.0 mm	435 m	560 m	625 m
8.0 mm	330 m	435 m	475 m

Reel

Inner core diameter	A	320 mm		A	270 mm	A	270 mm	
Reel height		195 mm			404 mm		506 mm	
Flange diameter		580 mm			432 mm		432 mm	
Width	B	460 mm	C	550 mm	D	533 mm	D	533 mm
Height		720 mm		915 mm		574 mm		574 mm
Depth		260 mm		350 mm		635 mm		635 mm
Material	steel powder coated			reinforced polymer		reinforced polymer		
Colour	black			black		black		
Weight (without cable)	12 kg			9.6 kg		9.8 kg		

Carrier

Type	frame with handle and optional with wheels	frame with handle	frame with handle
------	--	-------------------	-------------------

C





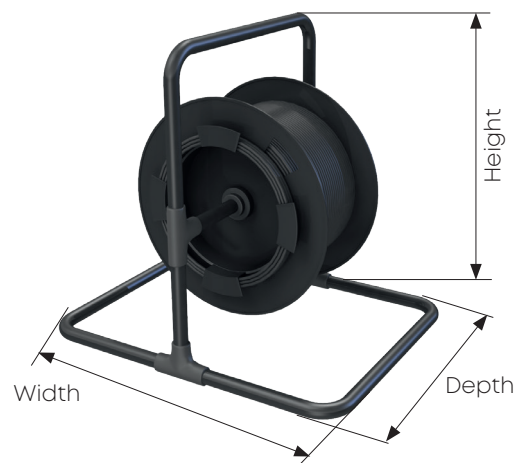



D







* Available without carrier frame (reel only)

MASTERLINE Mobile

Accessories





Description	Weight	Item No.	
Solid rubber wheels and long handle for MRPS 400	2.5 kg	84018981	
Trolley for reel MRMS 680 Solid rubber wheels	4.0 kg	85090573	
Carrier for MRPO 290 Aluminium tubular frame with splint	2.1 kg	85096702	
Carrier for MRPO 485 Aluminium tubular frame with splint	2.1 kg	85096708	
Carrier for MRPO 720 Aluminium tubular frame with splint	4.1 kg	85096709	
Carrier for MRPO 975 Aluminium tubular frame with splint	4.1 kg	85096710	

Cleaning of ODC connectors



Q-ODC-2 1.25 mm ferrule	ODC-2 1.25 mm ferrule	ODC-4 1.25 mm ferrule
		
Cleaning tools for ODC connectors	Item no.	Picture
IBC cleaner for 1.25 mm ferrules	84108852	



Comments

- Same IBC cleaner of all types of ODC connectors
- Wet cleaning for ODC connectors not recommended
- Dry cleaning of end face

<p>ODC plug cleaning</p> <ul style="list-style-type: none"> • Remove the purple guide cap from the device. • Extend the tip of the cleaner approx. 1 – 2 mm and insert it into the plug straight forward. • Risk of tip breakage. 	
<ul style="list-style-type: none"> • Push device up to the stop twice. A "click" sound indicates the end of each cleaning cycle. 	
<p>ODC socket/extension cleaning</p> <ul style="list-style-type: none"> • Open the guide cap from the device. • Insert the guide into the socket over the ferrule . • Push the device up to the stop twice. A "click" sound indicates the end of each cleaning cycle. 	
<p>Identification of remaining cleaning yarn</p> <ul style="list-style-type: none"> • The window indicates if there is still cleaning yarn available. When the cleaning yarn is used up the indicator is completely red. • Can be used for about 500 cleaning cycles. 	

Cleaning of Q-ODC-12/24 connectors

Q-ODC-12 plug plastic ferrule (PPS)	Q-ODC-12 socket plastic ferrule (PPS)	Q-ODC-12 extension plastic ferrule (PPS)
		

Cleaning tools for Q-ODC-12/24 connectors	Item no.	Picture
IBC cleaner for MTP ferrule	85017030	
Swab – pins cleaning	84139207	
Cleaning brush – pin holes cleaning (plug)	85099339	
Plug Adapter to IBC cleaner	85025275	
Socket/extension/rear mount Adapter to IBC cleaner	85025276	

Cleaning of Q-ODC-12 connectors

Cleaning of end face

Important notice

- If the Q-ODC-12 is connected to an active laser during cleaning, then the use of laser protection glasses is mandatory.
- The fibers must not point towards the eyes.



Plug pin holes cleaning

- Wet the cleaning brush with isopropyl alcohol and dab it onto a cleaning tissue. Insert the cleaning brush into the pin hole and move it back and forward twice.
- The metal of the brush must not come into contact with the ferrule. Avoid any damage to the holes, ferrule and fibers.



Socket/extension/rear mount pins cleaning

- Wet the cleaning brush with isopropyl alcohol and dab it onto a cleaning tissue.
- Clean the pins on all sides.
- Avoid any damage to the ferrule and fibers.







Ferrule/fibers end face cleaning



- Note the key and the keyway orientation of the connector and the cleaning adapter.
- Insert the IBC cleaner with mounted Q-ODC-12 adapter into the connector.



Cleaning of standard connectors

LC 1.25 mm ferrule	SC 2.5 mm ferrule	E-2000TM 2.5 mm ferrule
		



Cleaning tools for dry cleaning	Item no.	Picture
Cleaner IBC, ODC, 1.25 mm	84108853	
Cleaner IBC, 2.5 mm	84095171	

Optional tools for wet cleaning	Item no.	Picture
ITW Chemtronics QbE Cleaning System	84041085	
ITW Chemtronics Electro-Wash MX Fiber Cleaning Pen	84041105	

Dry cleaning of end face

<p>Connector cleaning</p> <ul style="list-style-type: none"> • Open the guide cap from the device. • Insert the connector ferrule into the guide. • Push the device up to the stop twice. A "click" sound indicates the end of each cleaning cycle. 	
<p>Cleaning through adapter</p> <ul style="list-style-type: none"> • Remove guide cap from the device. • Extend the tip of the cleaner approx. 1-2 mm and insert it into the adapter. • Risk of tip breakage. • Push device up to the stop twice. A "click" sound indicates the end of each cleaning cycle. 	
<p>Identification of remaining cleaning yarn</p> <ul style="list-style-type: none"> • The window indicates if there is still cleaning yarn available. When the cleaning yarn is used up the indicator is completely red. • Can be used for about 500 cleaning cycles. 	

Cleaning of Q-XCO and FullAXS

Q-XCO LC with 1.25 mm ferrule	FullAXS LC with 1.25 mm ferrule
	

Cleaning tools for dry cleaning	Item no.	Picture
IBC cleaner, 1.25 mm	84108852	

Dry cleaning of end face

<p>Q-XCO cleaning</p> <ul style="list-style-type: none"> • Open the guide cap from the device and insert the LC ferrule into the guide • Push the device up to the stop twice. A "click" sound indicates the end of each cleaning cycle. 	
<p>FullAXS cleaning</p> <ul style="list-style-type: none"> • Open the guide cap from the device and insert the LC ferrule into the guide. • Push the device up to the stop twice. A "click" sound indicates the end of each cleaning cycle. 	

Cleaning of Expanded Beam Connectors

EBC with lenses	Other types e.g. ProBeam Jr.
	

EBC cleaning



1. Wash connector or front of bulkhead with mounted protective cap with fresh and clean water, if they are covered with excessive dirt.
2. **IMPORTANT:** Clean insert surfaces and lenses only when they are touched or otherwise contaminated.
3. Remove the protective cap. Turn grip of connector and protective cap in opposite directions, until threads are completely free.
4. Blow away dirt particles from the alignment pin, ball lenses and insert surface with clean dry air.
5. Moisten a large swab with isopropyl alcohol, electro-wash PX or equivalent. Using a back-and-forth or swirling motion, wipe the alignment pin, ball lenses, insert surface and mating surface. Use only light pressure on the ball lenses to avoid scratches.



6. If seal of grip or insert, connector threads, protective cap threads and front surfaces are dirty, then these should also be cleaned with a moistened large swab. Use again isopropyl alcohol, electro-wash PX or equivalent.
7. Moisten a small swab with isopropyl alcohol, electro-wash PX or equivalent. Using a back-and-forth or swirling motion, wipe the alignment pin hole.
8. Blow clean dry air over the lenses until remaining solvent and stray particles are removed.
9. Inspect the ball lenses to make sure any contamination is removed. If necessary, repeat steps 4 to 8 until the surfaces are clean.
10. Re-install the protective cap by turning grip of connector and protective cap in opposite directions and tighten them properly.



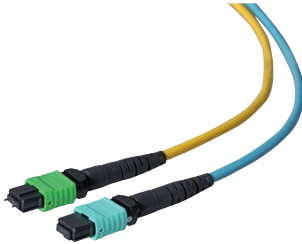

Dry Cleaning of MTP Connectors

MTP connector MT ferrule	MTP adapter
	

Cleaning tools for dry cleaning	Item no.	Picture
OPTIPOP R cassette for MTP MALE connectors	84097539	
OPTIPOP R cassette for MTP FEMALE connectors	84097538	
OPTIPOP R cassette refill (6 x reels)	84097551	
IBC MTP cleaner MALE and FEMALE	84097537	
MTP cleaning brush	85099339	

Dry cleaning of end face

<p>MTP connector cleaning</p> <ul style="list-style-type: none"> • Select the appropriate cleaner for male/female. • Depress the green lever so that a fresh area of cleaning cloth is exposed. • Position the ferrule against the cloth so that the fibers are in contact with the cleaning material. In the case of angled connectors, the ferrule will need to be adjusted accordingly. • Wipe the connector in the direction shown on the cassette. • Release the grip to seal off the cleaning cloth. • Re-inspect the ferrule with a 200 x microscope. • If still contaminated repeat all steps once again. • Ensure that the connector does not touch any hard surfaces. 	
<p>In-port MTP connector cleaning</p> <ul style="list-style-type: none"> • Insert the IBC cleaner into the adapter where the connector is mated. • Rotate the tape feeder wheel as indicated on the cleaner (3 x). • Inspect the connector with a 200 x microscope. • If still contaminated repeat steps once more. 	

Wet Cleaning of MTP Connectors

Wet cleaning of end face

MTP connector cleaning

- Apply an approved cleaning fluid to a small area of lint-free cleaning cloth.
- Wipe the connector over the damp area.
- For female MTP connectors use the cleaning brush and fluid to remove any debris from the pin holes or pins.
- Wipe the connector over a dry area of cloth and allow it to dry.
- Let the ferrule air-dry before inspecting with a 200 × microscope.



In-port MTP connector cleaning

- Insert the IBC cleaner into the adapter where the connector is mated.
- Rotate the tape feeder wheel as indicated on the cleaner (3 ×).
- Inspect the connector with a 200 × microscope.
- If still contaminated repeat steps once more.



End face inspection of fiber optic connector

Requirements	Recommended products
Min. 200 × magnification Monitor inspection (safety)	JDSU/Westover



For end face inspection of different fiber optic connectors, specific adapters are necessary.

Example for MTP adapter

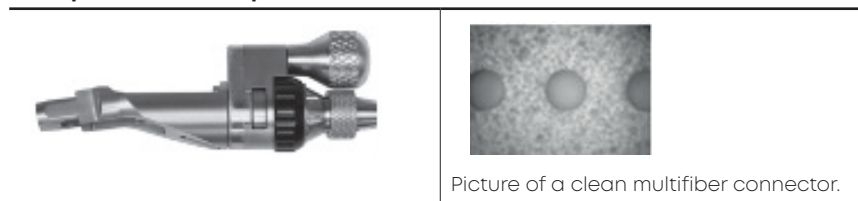

Note: A MTP/MPO contain at least 12 fibers, every fiber needs to be individually optical inspected according the mentioned parameters at the beginning of the document.

Cleaning Assessment Criteria

<p>OK</p>	
<p>NOT OK</p>	
<p>NOT OK</p>	

Selected RF products



HUBER+SUHNER develops and produces robust, small form factor antennas for various industrial applications.

[Go to external document/link ↗](#)

SENCITY® Omni-S Cellular/LTE (US)



Features

- Omni-directional cellular/4G LTE (US) SISO antenna
- Rugged and low profile cabinet and pole/wall mount antenna
- Supporting mobile bands LTE 698 to 862 MHz, cellular 1710 to 2170 and LTE 2300, 2500, 2600 MHz bands
- Single hole cabinet or wall/pole mounting
- For outdoor and indoor applications
- Ingress protection IP66/IP67 (IP69k)

Specifications

Electrical data			
Frequency (MHz)	698 to 862	1710 to 2170	2300 to 2690
VSWR	1.8	1.8	1.8
Gain (dBi)	2	5	3

General data	
Nominal impedance (Ω)	50
Polarisation	vertical
Composite power max. (W)	10

Mechanical data	
Dimensions (height x diameter)	33.2 x 145 mm (1.31 x 5.7 in)
Weight	0.3 kg (0.66 lbs)
Connector	SMA (male)
Cable type	ENVIROFLEX_316_D

Environmental data	
Environment	outdoor
Operation temperature (°C)	-55 to 85
RoHS 2011/65/EU	compliant

Material data	
Radome colour	RAL 7044 (grey)
Radome material	PC (polycarbonate)

Ordering information

Description	Item no.	Version
1399.19.0225	85065467	pigtail with SMA (male)

SENCITY® Omni-S 4×4 WiFi MIMO



Properties

- Omni-directional 4x4 WiFi MIMO and LTE 2300, 2600 and 3500 MHz antenna
- Rugged and low profile cabinet and pole/wall mount antenna
- Supports WiFi dual-band 2.4 to 2.5/4.9 to 6 GHz, IEEE 802.11 b/g/a/h/p/n/ac and cellular LTE 2300, 2500, 2600 and 3500 MHz band configurations
- Single hole cabinet mounting, for outdoor and indoor applications
- Vandalism proof „IK10“ acc. to IEC 62262/2002-02

Specifications

Electrical data				
Frequency (MHz)	2300 to 2500	2500 to 2690	3400 to 3800	4900 to 5975
VSWR	1.7	1.8	2	1.5
Gain (dBi)	1.5	1.5	2	3.5

General data	
Nominal impedance (Ω)	50
Polarisation	vertical
Composite power max. (W)	10

Mechanical data	
Dimensions (height x diameter)	33.2 x 145 mm (1.31 x 5.7 in)
Weight	0.32 kg (0.70 lbs)
Connector	SMA-reverse (male)
Cable type	ENVIROFLEX_316_D

Environmental data	
Environment	outdoor
Operation temperature (°C)	-55 to 85
RoHS 2011/65/EU	compliant

Material data	
Radome colour	RAL 7044 (grey)
Radome material	PC (polycarbonate)

Ordering information

Description	Item no.	Version
1399.59.0005	85031687	4 x pigtail with SMA-reverse (male)

SENCITY® Spot-S circular polarized



Properties

- Small UHF RFID or mobilecommunication small band antenna
- Polarization circular – right hand
- Frequency-band: 865 to 870 MHz
- Indoor/outdoor mounting IP66/IP67

Specifications

Electrical data	
Frequency (MHz)	865 to 870
VSWR	2
Gain (dBi)	3.5
3 dB beamwidth (h) (°)	135
3 dB beamwidth (v) (°)	90

General data	
Nominal impedance (Ω)	50
Polarisation	circular right
Composite power max. (W)	10

Mechanical data	
Dimensions (height x width x depth)	101 x 81 x 36 mm (3.98 x 3.19 x 1.42 in)
Weight	0.18 kg (0.40 lbs)
Connector	SMA (female)

Environmental data	
Environment	outdoor
Operation temperature (°C)	-40 to 85
RoHS 2011/65/EU	compliant

Material data	
Radome colour	RAL 7044 (grey)
Radome material	PC (polycarbonate)

Ordering information

Description	Item no.	Version
1308.99.0004	84075241	SMA (female)

SENCITY® Spot-S 3×3 WiFi MIMO



Features

- Directional, planar, linear polarized WiFi MIMO antenna
- WLAN IEEE 802.11 a/h/n/p/ac, 3×3 MIMO with three ports
- WiFi 5 GHz bands 5.15 to 5.935 GHz
- For outdoor and indoor applications
- Ingress protection IP66 and IP67
- Wall mounting material included

Specifications

Electrical data	
Frequency (MHz)	5150 to 5935
VSWR	1.7
Gain (dBi)	8
Isolation (dB)	17
3 dB beamwidth (h) (°)	65
3 dB beamwidth (v) (°)	65

General data	
Nominal impedance (Ω)	50
Polarisation	-45°/vertical/+45°
Composite power max. (W)	2

Mechanical data	
Dimensions (height × width × depth)	101 × 81 × 36 mm (3.98 × 3.19 × 1.42 in)
Weight	0.27 kg (0.59 lbs)
Connector	QMA (female) or N (male)

Environmental data	
Environment	outdoor
Operation temperature (°C)	-40 to 85
RoHS 2011/65/EU	compliant

Material data	
Radome colour	RAL 7044 (grey)
Radome material	PC (polycarbonate)

Ordering information

Description	Item no.	Version
1356.35.0003	84125104	3 × QMA (female)
1356.17.0078	84076862	3 pigtails N (male)

SENCITY® Spot-M 2×2 WiFi MIMO



Properties

- Directional, planar, dual linear vertical and horizontal polarized WiFi antenna
- For 2×2 WiFi MIMO configuration – WLAN WiFi IEEE 802.11 a/h/n
- Frequency bands for 5.15 to 5.875 GHz per each port, high gain 19 dBi
- For outdoor or indoor applications
- Ingress protection IP67

Specifications

Electrical data	
Frequency (MHz)	5150 to 5875
VSWR	1.7
Gain (dBi)	19
Isolation (dB)	30
3 dB beamwidth (h) (°)	17
3 dB beamwidth (v) (°)	17
Front to back ratio (dB)	30
Co/Crosspolar ratio (dB)	20
Sidelobes (v)	ETSI EN 302 217-4-2 V1.5.1 CLASS 2
General data	
Nominal impedance (Ω)	50
Polarisation	horizontal and vertical
Composite power max. (W)	6
Mechanical data	
Dimensions (height × width × depth)	190 × 190 × 30 mm (7.48 × 7.48 × 1.18 in)
Weight	0.7 kg (1.54 lbs)
Connector	N (female)
Environmental data	
Environment	outdoor
Operation temperature (°C)	–55 to 70
RoHS 2011/65/EU	compliant
IP rating	IP67
Material data	
Radome colour	RAL 9002 (grey-white)
Radome material	PC (polycarbonate)
Back/base plate material	aluminium

Ordering information

Description	Item no.	Version
1356.17.0023	84018715	2 × N (female)

Ex entry devices for coaxial lines

The Ex entry devices are used to feed-through signals via a coaxial RF transmission line between the non-exposed and exposed side of an electrical equipment of the type of equipment protection by flameproof enclosure. Ex Entry devices are approved for use in potentially explosive atmosphere or hazardous locations and areas of Zone 1 (gas) and Zone 21 (dust) for coaxial cabling/interconnection with Ex-d enclosures. These products are of specific interest where an active access point is placed within an Ex certified enclosure, which needs to be connect with an antenna (Ex-i or in a housing). Different cable connectors in combination with the appropriate cable allow maximum flexibility in routing cables at highest possible performance and lowest possible losses. Explosion-proof device for use within Zone 1 or Zone 21 of potentially explosive atmospheres, compliant to IEC/EN 60079.

Type of protection:

- Flameproof „d“ acc. IEC/EN 60079-1
- Intrinsic safety „e“ acc. IEC/EN 60079-7
- Enclosure „t“ acc. IEC/EN 60079-31
- IECEx Certification number: IECEx SEV 16.0009X
- ATEX Certification number: SEV 15 ATEX 0189 X

Type	Thread style	Thread dimension *	Thread length	Width across flats WAF	Across corners	RF connectors*	
		M / mm NPT / inch	mm	mm	mm	Exposed**	Non-exposed*
9097.00.ED01-M18	Metric	M18 x 1.5	11.8	27	29.9	N-jack	SMA-jack
9097.00.ED02-M18	Metric	M18 x 1.5	11.8	27	29.9	TNC-jack	SMA-jack
9097.00.ED01-3/8	NPT	3/8	11.8	27	29.9	N-jack	SMA-jack
9097.00.ED02-3/8	NPT	3/8	11.8	27	29.9	TNC-jack	SMA-jack

IECEx marking: II 2G Ex db eb IIC T6...T5 Gb
II 2D Ex tb IIIC T85°C...T100°C Db

* M20 or 1/2 in thread on request

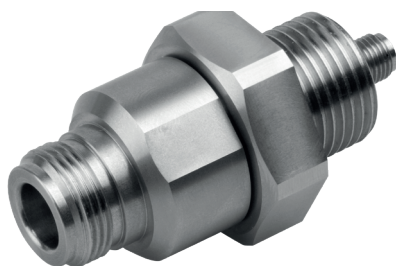

RF-over-Fiber

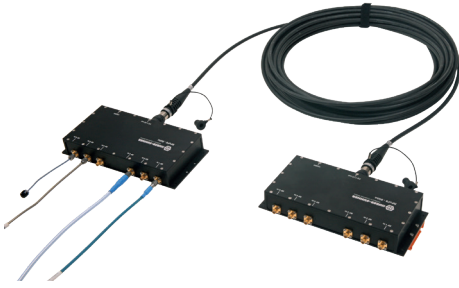

Driven by a philosophy of providing high density RF connectivity, while significantly reducing cable footprints, HUBER+SUHNER's single mode, simplex and duplex systems are both flexible and perfect for harsh environments. Flexibility is achieved by providing customers with a wide range of options when it comes to inter-connectivity, while the scalability of the systems enables an unlimited RF connectivity density.

The use of HUBER+SUHNER's renowned components, such as RADOX and Q-ODC-12, ensures that the system can be deployed in any environment and with a significantly smaller cable footprint.

The standard RFoF modules are available in 1, 6 and 12 ports and cover a wide frequency range of 1 MHz to 20 GHz. The systems are capable of covering distances of up to 100 km and are perfect for applications requiring secure, low loss, light-weight and high density connectivity.

Properties:

- Allow for greater distances between the RF source and the RF receiver system
- Are immune to EMI and RFI
- Are immune to EMP
- Are more difficult to intercept („tap“)
- Are lighter in weight

RF-over-Fiber		# of RF ports				Key technical parameters/features									
Item	Item description	1	3	6	12	Simplex	Duplex	Frequency MHz		Gain flatness*	Noise figure*	SFDR*	OIP3*	Single-mode	Max. link distance**
								from	to	dB/100 MHz	dB	dB Hz ^{2/3}	dBm		
85073881	RFoF1 – 3 GHz (TX)	•				•		1	3000	< 1.5	15	100	20	•	100
85073882	RFoF1 – 3 GHz (RX)	•				•		1	3000	< 1.5	15	100	20	•	100
85073883	RFoF1 – 3 GHz (TRM)	•				•		1	3000	< 1.5	15	100	20	•	100
85071061	RFoF6 – 3 GHz (TX)			•			•	1	3000	< 1.5	15	100	20	•	100
85071062	RFoF6 – 3 GHz (RX)			•			•	1	3000	< 1.5	15	100	20	•	100
85071063	RFoF12 – 3 GHz (TX)				•		•	1	3000	< 1.5	15	100	20	•	100
85071064	RFoF12 – 3 GHz (RX)				•		•	1	3000	< 1.5	15	100	20	•	100
85071065	RFoF3 – 3 GHz (TRM)		•				•	1	3000	< 1.5	15	100	20	•	100
85071066	RFoF6 – 3 GHz (TRM)			•			•	1	3000	< 1.5	15	100	20	•	100
85065392	RFoF6 – 6 GHz (TX)			•			•	300	6000	< 1.5	20	100	10	•	100
85065393	RFoF6 – 6 GHz (RX)			•			•	300	6000	< 1.5	20	100	10	•	100
85074581	RFoF6 – 6 GHz LN (TX)			•			•	300	6000	< 0.7	7	105	10	•	100
85074578	RFoF6 – 6 GHz LN (RX)			•			•	300	6000	< 0.7	7	105	10	•	100
85065394	RFoF12 – 6 GHz (TX)				•		•	300	6000	< 1.5	20	100	10	•	100
85065395	RFoF12 – 6 GHz (RX)				•		•	300	6000	< 1.5	20	100	10	•	100
85071630	RFoF3 – 6 GHz (TRM)		•				•	300	6000	< 1.5	20	100	10	•	100
85071631	RFoF6 – 6 GHz (TRM)			•			•	300	6000	< 1.5	20	100	10	•	100
85072903	RFoF1 – 20 GHz (TX)	•					•	200	20 000	< 1.0	45	100	28	•	100
85072904	RFoF1 – 20 GHz (RX)	•					•	200	20 000	< 1.0	45	100	28	•	100
85076291	RFoF1 – 20 GHz (TRM)	•					•	200	20 000	< 1.0	45	100	28	•	100
85077808	RFoF1 – 20 GHz LN (TX)	•					•	200	20 000	< 1.0	8	105	25	•	100
85077809	RFoF1 – 20 GHz LN (RX)	•					•	200	20 000	< 1.0	8	105	25	•	100

* Typical value(s)

** Real link distances are dependent on the application/environment.

RFoF6 – 3 GHz

Electrical data		Value			Remarks
		minimal	typical	maximal	
Frequency range	MHz	1		3000	3 dB bandwidth
Gain	dB	6	10	14	
Gain flatness	dB/100 MHz		< 1.5		
Noise figure	dB	12	15	25	
Spurious-free dynamic range	dB Hz ^{2/3}		100		
Max. input at 1dB compression	dBm		+0		
Max. input power for no damage	dBm		+15		
VSWR (input and output)	dB		< 1.8		
OIP3	dBm		+20		
Time delay	Ns		12		
Supply voltage transmitter	VDC	+11	+12	+16	max. 750 mA
Supply voltage receiver	VDC	+11	+12	+16	max. 500 mA
Temperature range	operating	°C	-40	+85	
	storage	°C	-40	+85	
RF input impedance	Ω	50			

Optical Data		Value			Remarks
		minimal	typical	maximal	
Fiber optic connectors		Q-ODC 12			
Fiber		single mode fiber 9/125 um			
Fiber power loss	dB/km		0.4		
Optical power in fiber	mW	3	6	10	
Side mode suppression ratio	dB	30	40		

Mechanical Data		Value			Remarks
		minimal	typical	maximal	
Module weight	kg	1.1			transmitter and receiver
Module dimensions	mm	220 × 100 × 34			transmitter and receiver
RF connectors		Q/MA/SMA female			

All specifications at 25 °C case temperature Tc, unless otherwise specified.

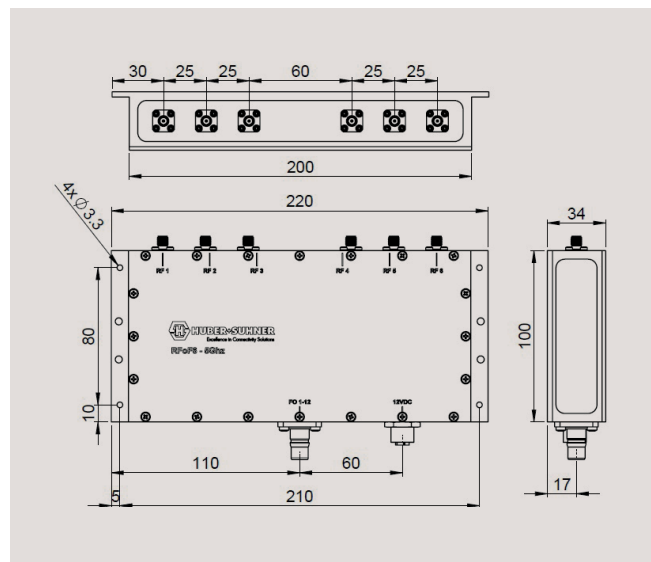

Radiating cable

SUCORAD_1/2_LMH_FR



Features

- Coaxial radiating cable
- 50 Ohm,
- 2700 MHz
- 80° C
- \varnothing 13.2 mm
- PE jacket

Specifications

Technical data	Material	Detail	Diameter
Centre conductor	copper	copper clad aluminium	4.8 mm
Dielectric	PE	physically foamed	12.2 mm
Outer conductor	copper	overlapping foil with slots	13.2 mm
Jacket	PE	halogen free, flame retardant, black	15.8 mm

Electrical Data	
Impedance	50 Ω +/- 2
Operating Frequency	2700 MHz
VSWR	\leq 1.3
Capacitance	76 pF/m
Velocity of signal propagation	88 %
DC breakdown voltage	3 kV
Insulation resistance	\geq 5 G Ω ·Km
Outer conductor resistance DC	\leq 4.0 Ω /Km
Inner conductor resistance DC	\leq 1.5 Ω /Km

Mechanical data	
Cable size	1/2"
Cable weight	21.8 Kg/100m
Minimum bending radius	200 mm
Tensile force	1100 N
Indication of slot alignment	embossed line 180° opposite

Environmental data	
Operating temperature	-30 to 85 °C
Installation temperature	-25 to 60 °C
Storage temperature	-30 to 80 °C
Flammability	IEC 60332-1-2, IEC 60332-3-24
Smoke density	IEC 61034
Halogen test, Smoke emission	IEC 60754-1, IEC 60754-2
2011/65/EU (RoHS – including 2015/863 and 2017/2102)	compliant
1907/2006/EC (REACH)	compliant
2015/305/EU (CPR)	compliant, EN50575:2017 class Eca
RoHS 2011/65/EU	compliant
IP rating	IP66/IP68

Installation Data	
Recommended clamp spacing	1 m
Recommended distance to wall	80 to 180 mm, 50 mm min.

Radiating cable

SUCORAD_1/2_LMH_FR

Transmission data

Frequency (MHz)	Nom. attenuation* (dB / 100m)	Nom. attenuation (dB / 100ft)	Coupling loss** (50% / 95%) (dB)
sea level 20° C, ambient temperature			
75	1.98	0.604	68 / 77
150	2.83	0.863	74 / 88
800	7.12	2.170	62 / 68
900	7.62	2.323	59 / 63
1900	12.48	3.804	59 / 66
2000	13.21	4.026	58 / 65
2200	14.40	4.389	63 / 72
2400	16.05	4.892	59 / 68
2600	18.05	5.502	59 / 69

* Attenuation and coupling loss are measured by free space method according to IEC 61196-4

** Attenuation and coupling loss values are given with tolerances of 5% and ± 5 dB

Suitable connectors

Item no.	85152701	85152704	85152696	85152692
HUBER+SUHNER type no.	11_N_12	21_N_12	11_716_12	21_716_12

Ordering information

Item no.	85150847
HUBER+SUHNER type no.	SUCORAD_1/2_LMH_FR

HUBER+SUHNER AG
Industry Segment
Degersheimerstrasse 14
9100 Herisau
Switzerland
Phone +41 71 353 41 11
hubersuhner.com

HUBER+SUHNER is certified to ISO 9001, ISO 14001, ISO 45001, EN/AS 9100, IATF 16949 and ISO/TS 22163-IRIS.

Facts

Fact and figures herein are for information only and do not represent any warranty of any kind.